



ICV Installation & Getting Started Guide

Metrics ICV

Version 4.5

Table of Contents

Installing the ICV Software	4
Obtain a Customer Portal Login	4
Important Note for upgrading Customers	5
Procedure to Upgrade ICV from 4.x to 4.5.....	5
Procedure to Install ICV - New Installations.....	10
Metrics Codewords	17
Software Codeword Information	17
Activate the ICV License:.....	18
Enter the Codewords.....	20
Configuring ICV	26
Probe Station Configuration	26
Instrument Configuration.....	30
Switch Matrix Configuration	31
Introductory Information	37
Goal of This Manual	37
Chapter 1- ICV Getting Started Guide.....	38
Introduction.....	38
Topics Covered	38
What is Metrics ICV Software?	39
Overview of Metrics ICV Software.....	40
Determining Software Version	41
Updating the Metrics ICV Software	42
Support.....	43
Chapter 2- Starting ICV	44
Introduction.....	44
Topics Covered:	44
The Metrics ICV Program Group	45
The Metrics ICV Toolbars	45
Test Development in Metrics ICV	48
Chapter 3- Creating Device Connections	51
Introduction.....	51
Topics Covered	51
What is a Device Connection?.....	52
Creating Device Connections	53
Testing the Connections.....	57
Saving the Switch Connection File.....	57
Chapter 4- Creating Measurements	58
Introduction.....	58
Topics Covered	58
What is Metrics ICS?	59
Configuring Metrics ICS.....	60
Polling an Instrument.....	61

Create a Sweep Measurement.....	62
Create a Spot Measurement	66
Executing the Measurement.....	70
Data Return	71
Saving the Measurement.....	72
Chapter 5- Creating a Module Test.....	73
Introduction.....	73
Topics Covered	73
What is a Module?	74
What a Module Test Does.....	75
Creating a Module Test Script	76
Chapter 6- Creating a Module List	89
Introduction.....	89
Topics Covered	89
What is a Module List?	90
The Coordinate System of the Module List.....	91
Creating a Module List	93
Importing a Module List	99
Chapter 7- Creating a Die Test	100
Introduction.....	100
Topics Covered	100
What is a Die?	101
What a Die Test Does	101
Creating a Die Test Script.....	102
Chapter 8- Creating Wafer Maps	110
Introduction.....	110
Topics Covered	110
Creating a Probe Plan with the Wafer Map Editor	111
Verifying the Wafer Map.....	116
Chapter 9- Run Test	121
Introduction.....	121
Topics Covered	121
Getting a Test Started.....	122
Chapter 10- Data Manipulation	131
Introduction.....	131
Topics Covered	131
Where is the Data?	132
Creating a Wafer Map.....	134
Exporting Data	148
Viewing Data	161
Chapter 11- System Backup and Restore.....	169
Introduction.....	169
Topics Covered	169
How to Backup	170
Special Requirements.....	171
How to Restore	172

Installation and Configuration

Installing the ICV Software

Obtain a Customer Portal Login

Please visit our website at www.metricstech.com to register your software, obtain your login credentials and be issued a temporary or permanent codeword. This process is typically completed within 24 hours or less.

The installation program for the Metrics ICV software installs all components necessary to run Metrics ICV. You can download the auto-extracting archive MTICV-45.EXE from the Metrics Technology website under Downloads link. Be sure to save the install file to your local hard disk before running the installation. Running the installation from the website will cause an installation error. You will need a valid customer login to enter the Software Downloads area.

NOTE: You should also download the latest available HotFix release which can be found in the same software list and designated MTICV-45-HFXX.EXE where the XX is the version number of the HotFix. HotFixes contain resolutions to any reported issues and some enhancements that have been added since the initial release of Metrics ICV 4.5. It is only necessary to apply the latest HotFix to your system since all updates are contained in the latest build. Save the HotFix file to your local computer and you will be able to install it after the base Metrics ICV installation is complete. *It is recommended that you keep an archive copy of all HotFixes applied.*

Important Note for upgrading Customers

The Metrics ICV setup program requires that you backup and uninstall the previous version. To do this, please perform the following steps:

DO NOT LEAVE YOUR BACKUP ARCHIVE IN THE METRICS DIRECTORY! COPY THE BACKUP.ZIP FILE TO A DIFFERENT LOCATION LIKE A USB DRIVE.

1. Go to the File Menu and select Backup
2. Enter the name of the backup ZIP archive in the default directory (i.e. C:\METRICS\ICS\backup.zip)
3. Allow the backup utility to complete then copy the .ZIP file to another drive location.

Metrics ICS files are now be stored in the windows file system. Existing tests should be opened and then saved in the Metrics\ics\projects directory.

After upgrading, some of the functions of the software will require that older scripts or features be modified. A complete list of deprecated features is contained in the *Metrics ICV Software Migration Guide*.

Procedure to Upgrade ICV from 4.x to 4.5

1. Download the Metrics ICV installer MTICV-45.exe to the hard drive of your computer.
2. Select the **MTICV-45.exe** application icon to start the installation program.

NOTE: The installer may take up to 10 seconds or longer to uninstall the previous version of the software before displaying the Welcome panel.

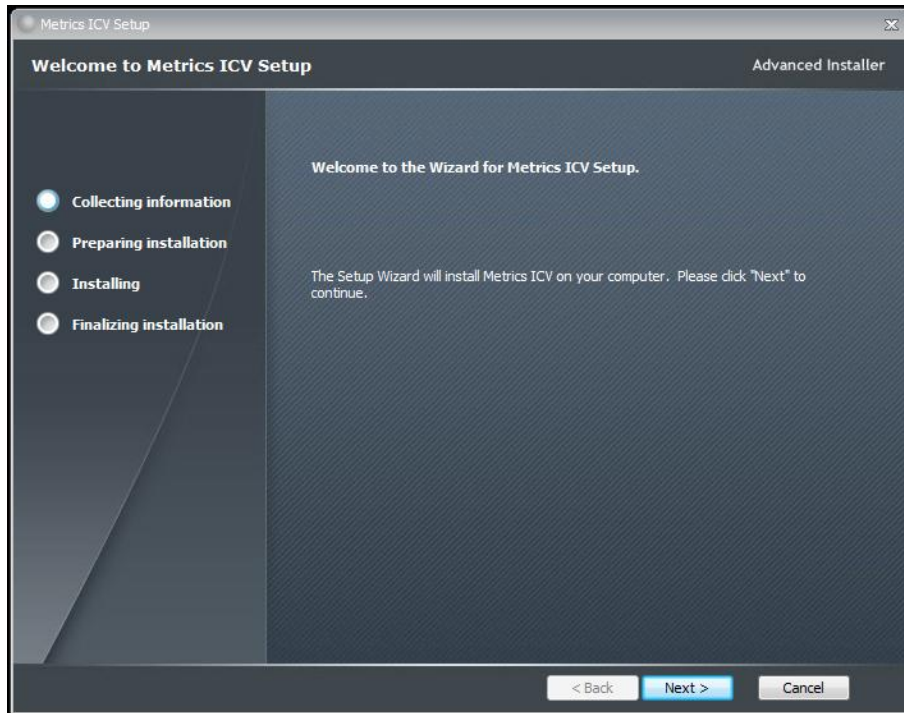

3. Click **Next** button on the "Welcome" panel.

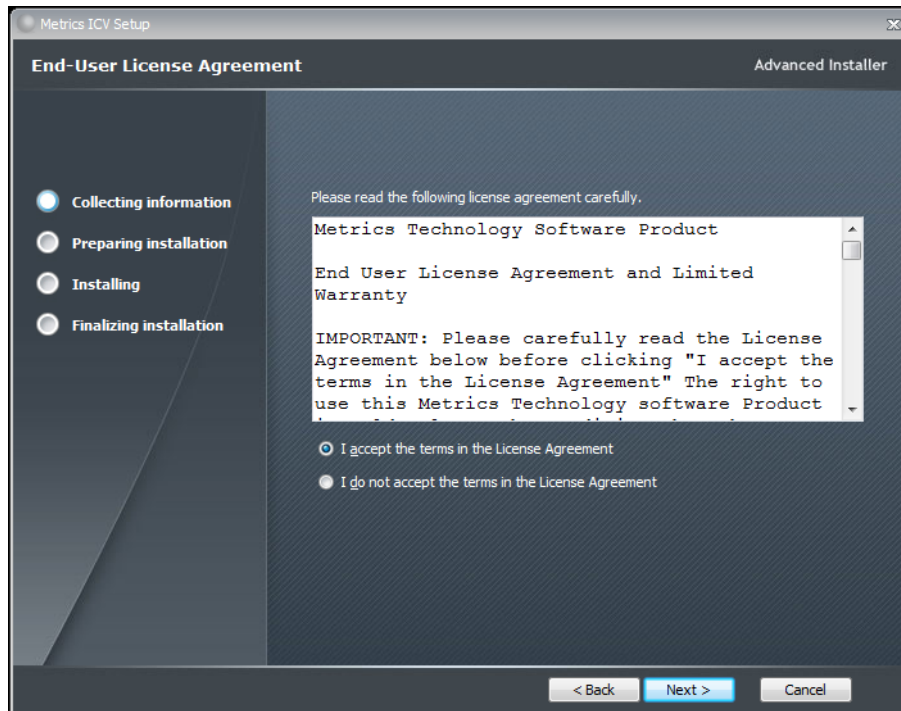

4. Read the "Software License Agreement" and click the **I agree to the terms in the License Agreement** button to agree to the terms, if you agree. Then click **Next**.

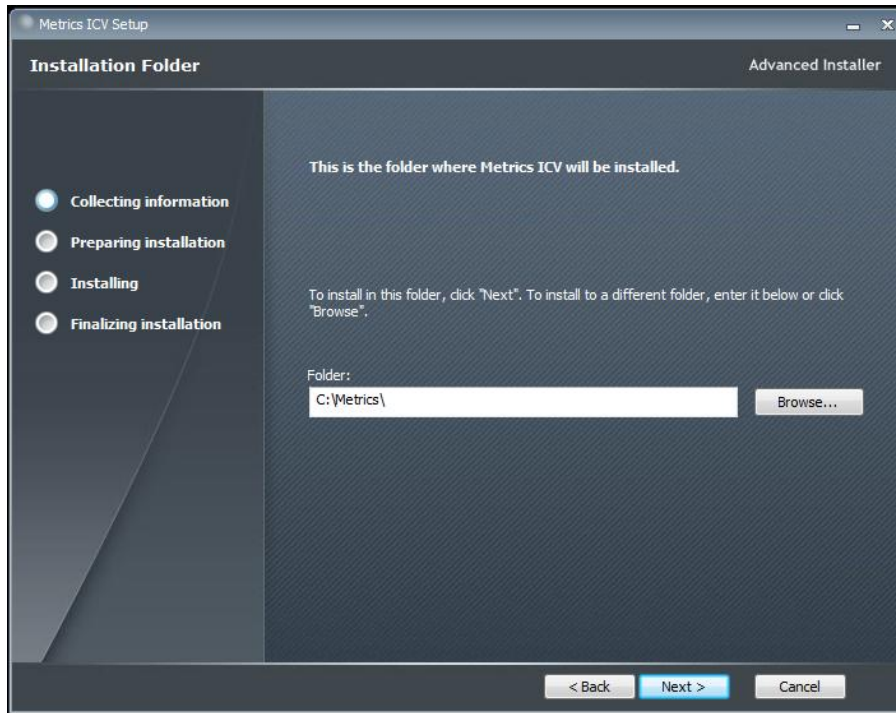

5. Choose "destination location" for installation and click the **Next** button.

NOTE: It is recommended to select the default C:\Metrics\ as the location to maintain compatibility with previous versions of the software backups.

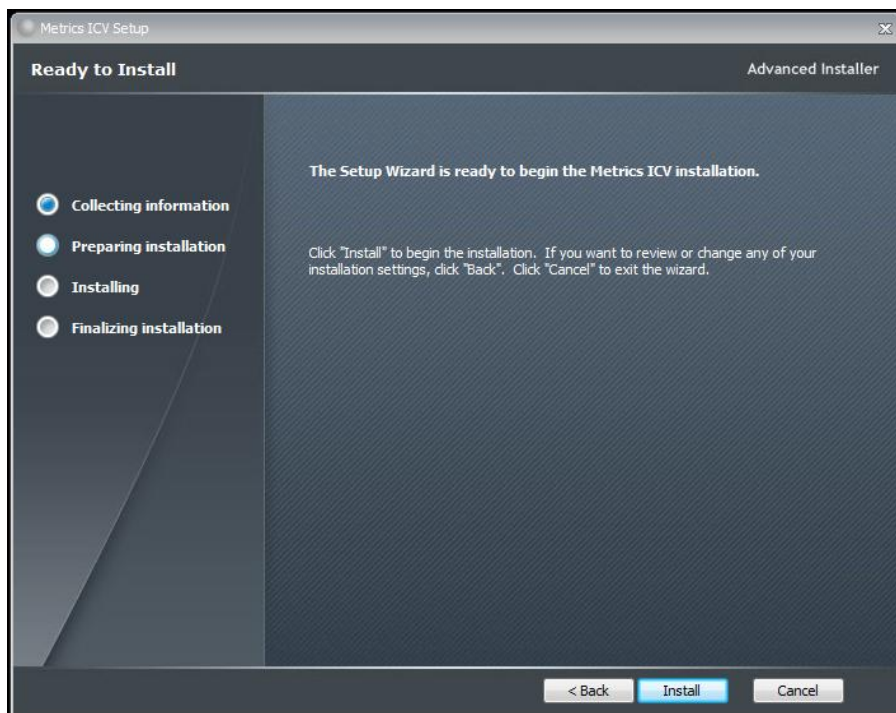

6. Click the **Install** button to begin the Metrics ICV installation.

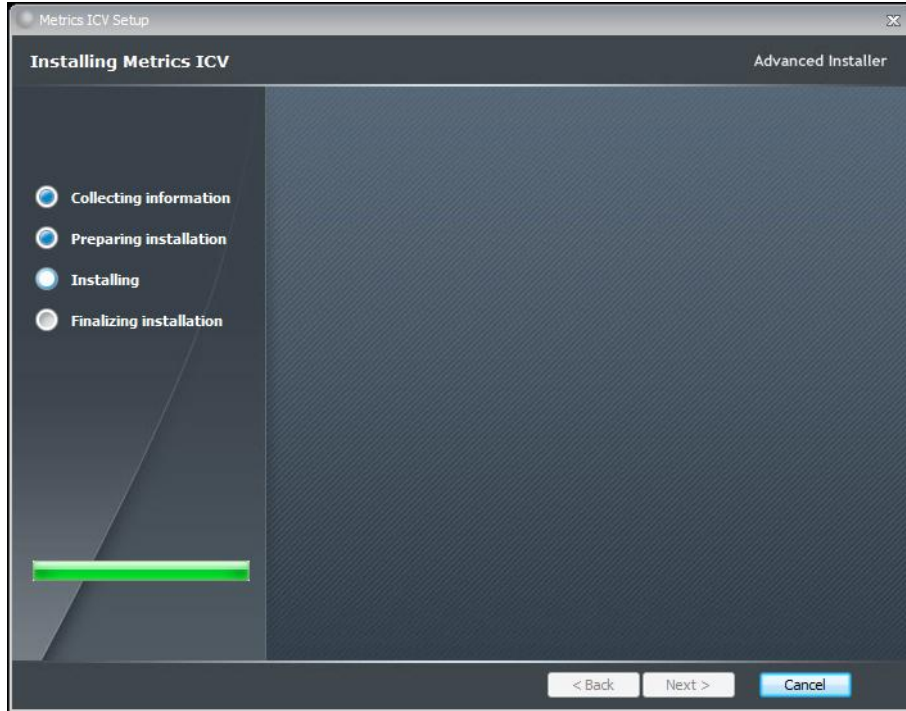

7. Allow the Metrics ICV installation to complete.

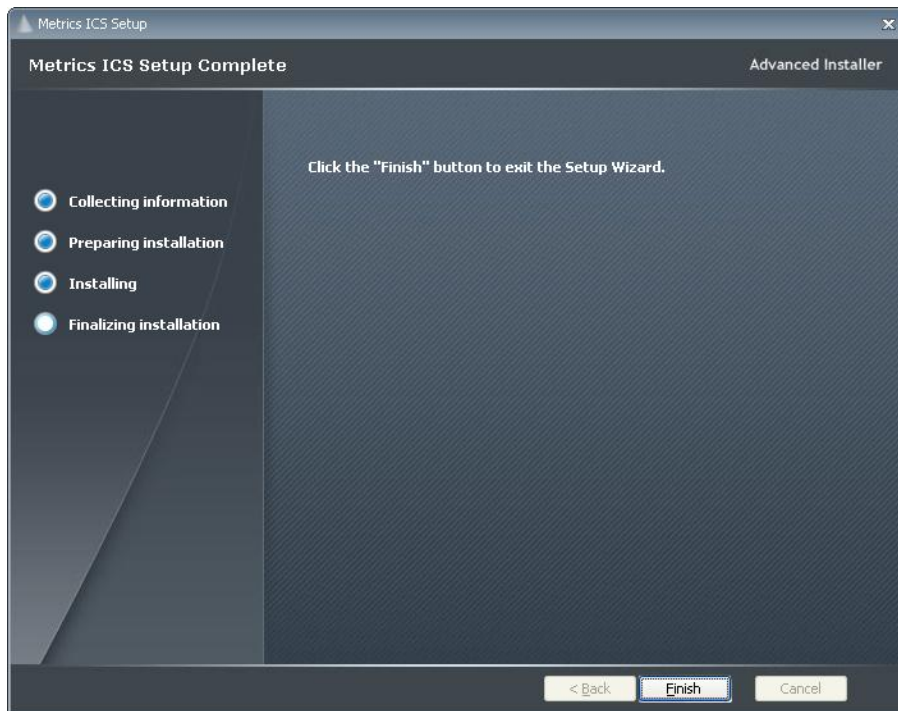

8. Then click Finish to complete the installation.

9. After the installation is finished, re-start the computer.

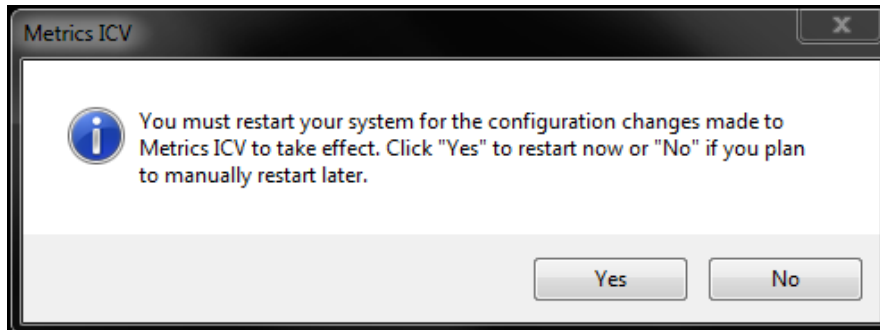

Procedure to Install ICV - New Installations

1. Execute the Metrics ICV installer.
2. Double clicking icon should automatically start the MTICV-45.exe installation program.

The installation will check for any prerequisites and start the Prerequisites Wizard to install the necessary software. Please note installation of these software components requires acceptance of the 3rd Party license agreements displayed during installation. Installation of some components can take additional time so you should allow more time for installation if these components are not already installed on your workstation PC.

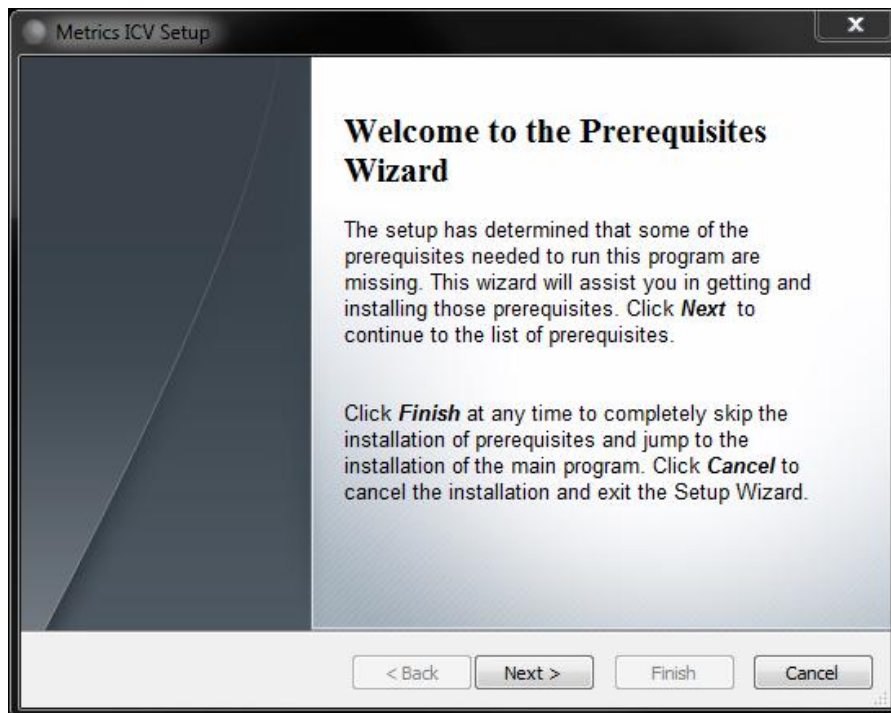

3. Click **Next** button on the "Welcome" panel.

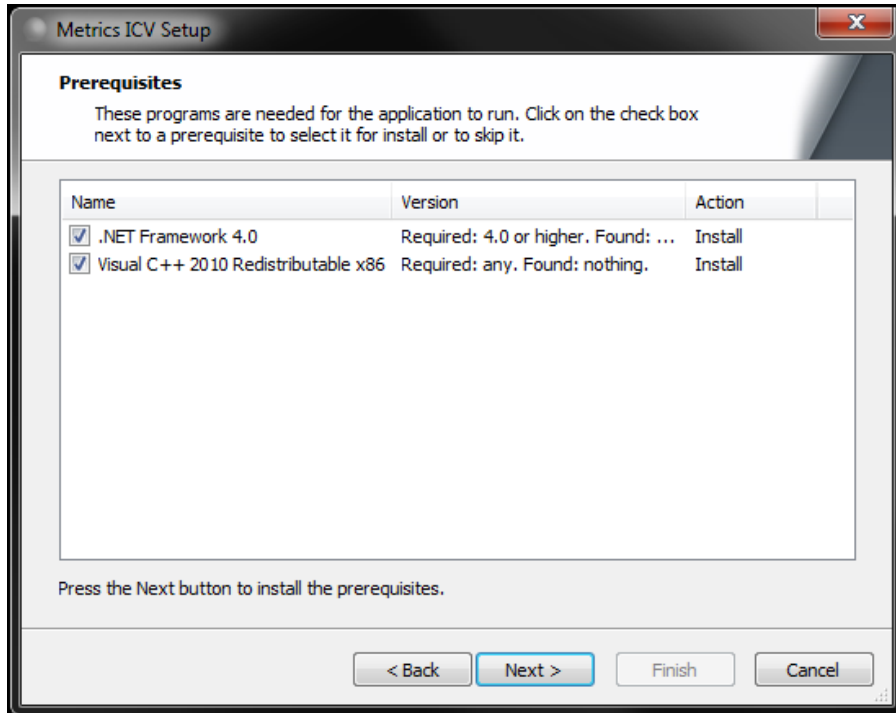

4. Click **Next** button on the "Prerequisites" panel.

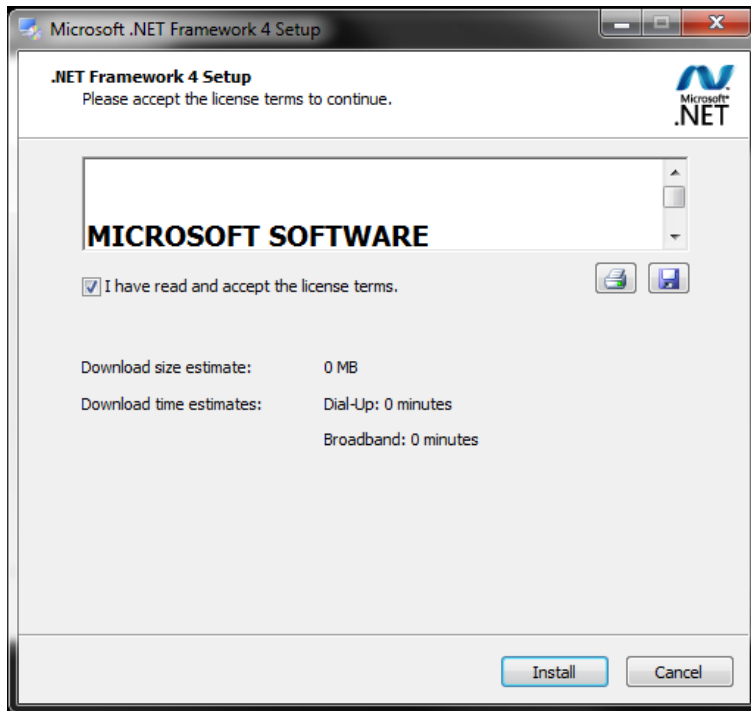

5. Click **I have read and accept the license terms** then click the **Install** button on the "Microsoft .NET Framework" panel.

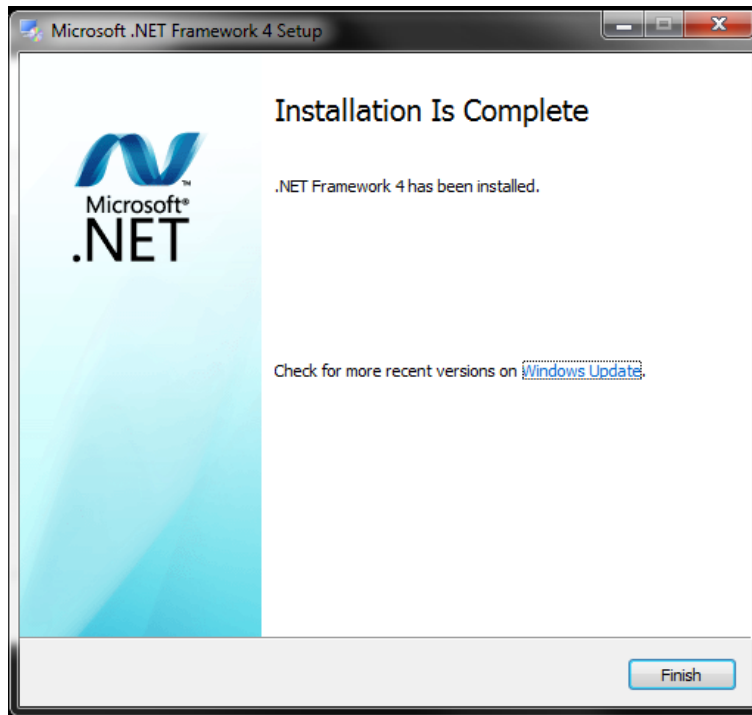

6. Click **Finish** to continue.

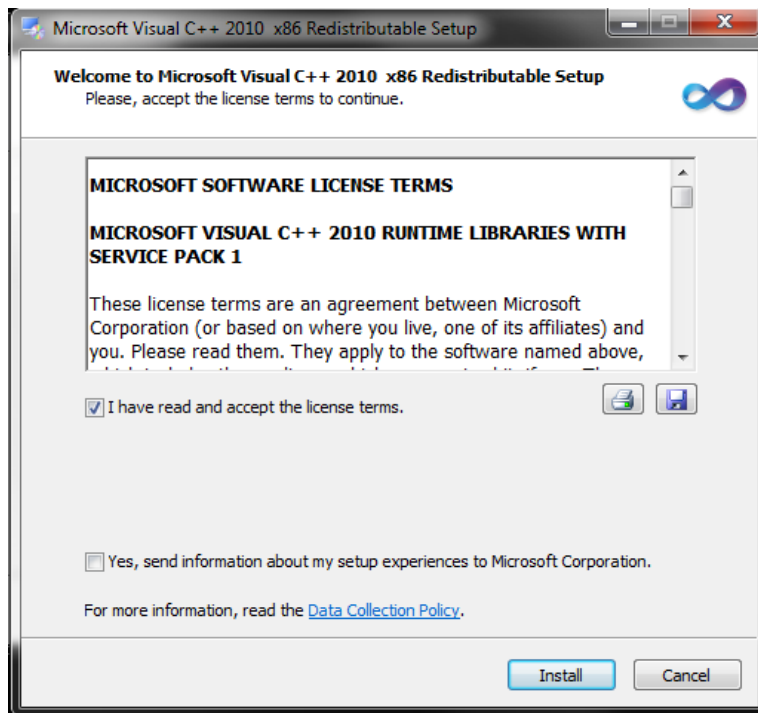

7. Click **I have read and accept the license terms** then click the **Install** button on the " Microsoft Visual C++ 2010-2022 Redistributable " panel.

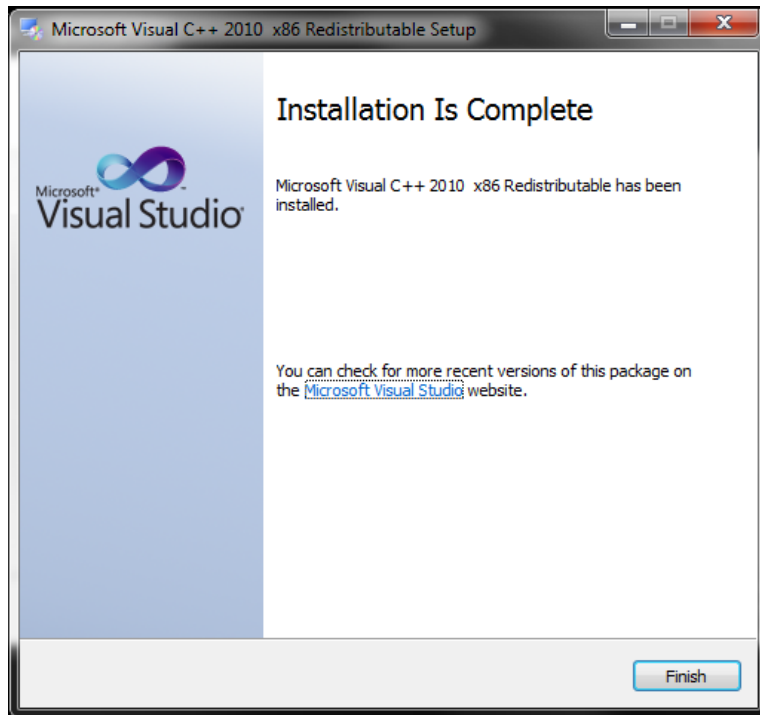

8. Click **Finish** to continue.

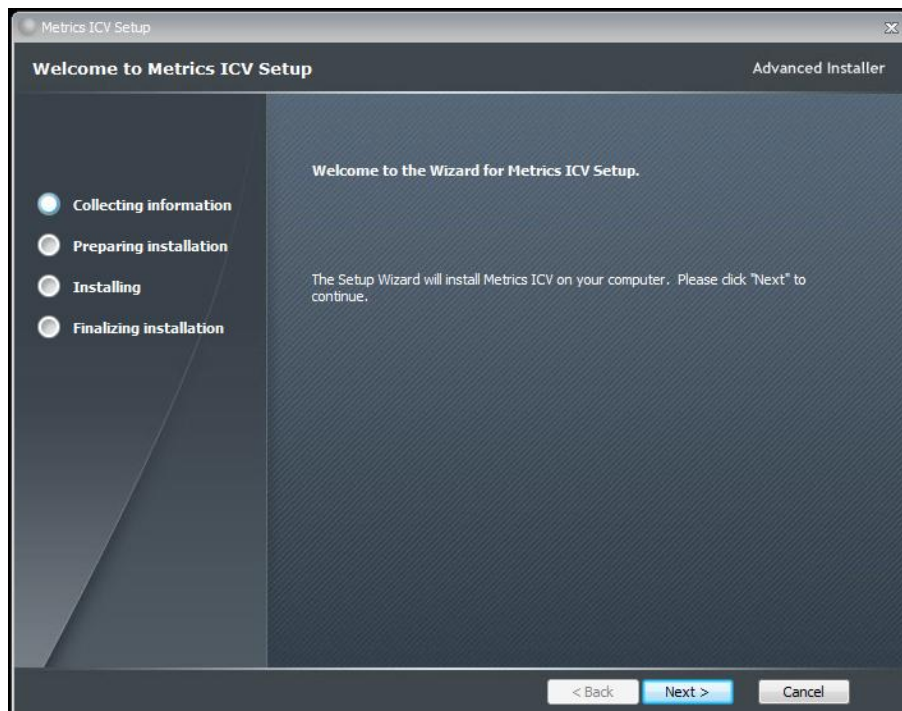

9. Click **Next** button on the "Welcome" panel.

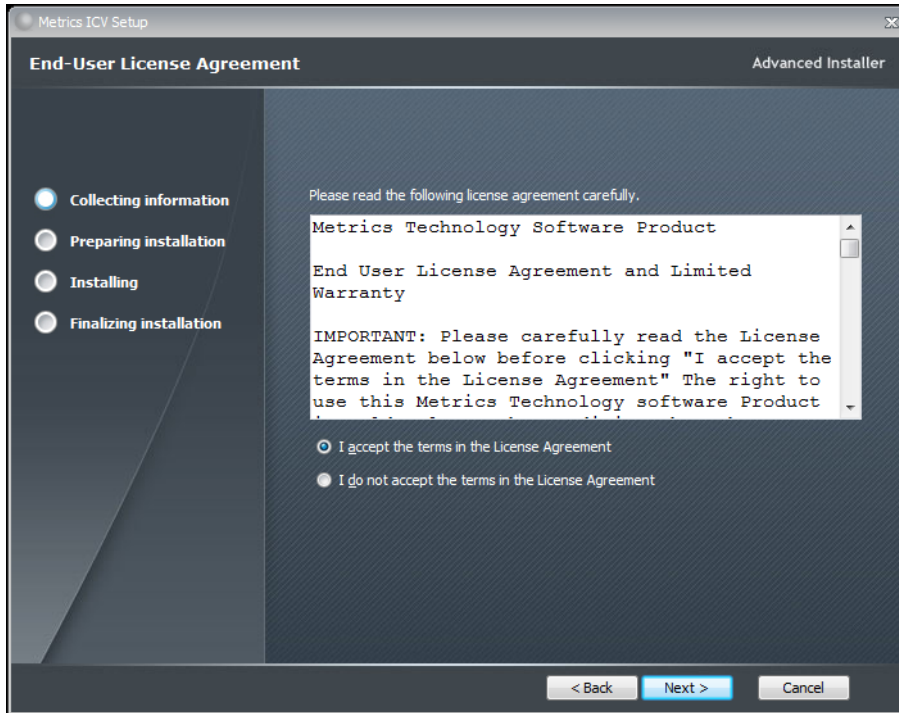

10. Read the "Software License Agreement" and click the **I agree to the terms in the License Agreement** button to agree to the terms. Then click **Next**.

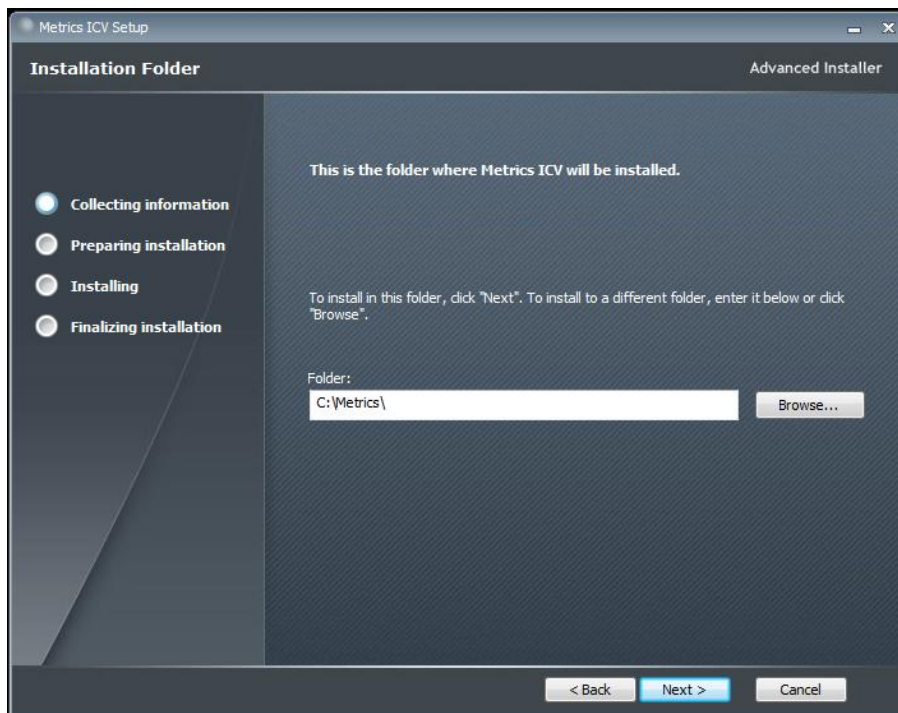

11. Choose "destination location" for installation and click the **Next** button.
Note: It is recommended to select the default C:\Metrics\ as the location to maintain compatibility with previous versions of the software backups.

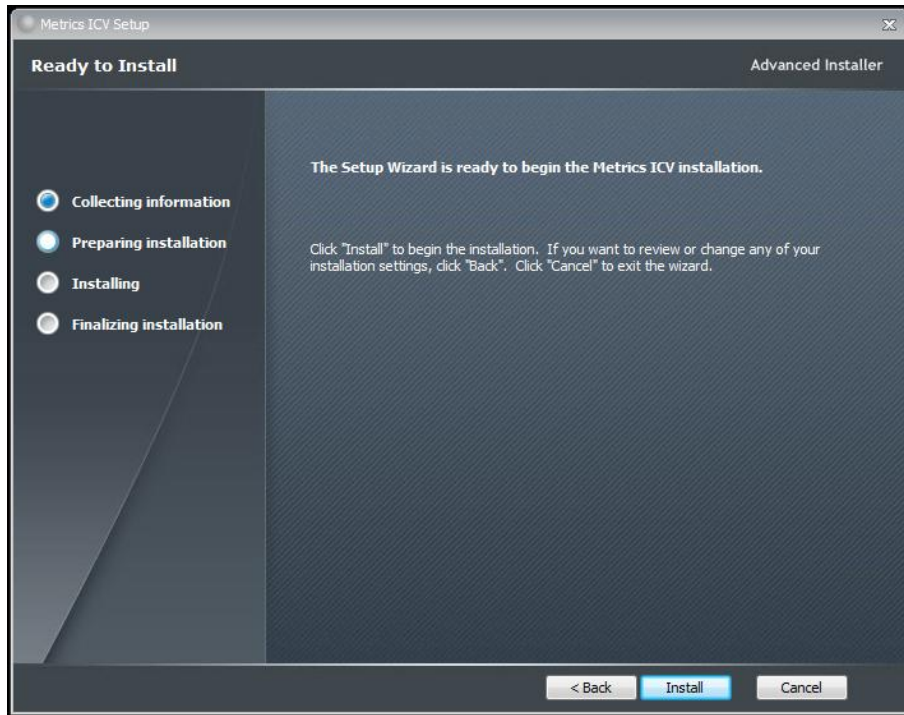

12. Click the **Install** button to begin the Metrics ICV installation.

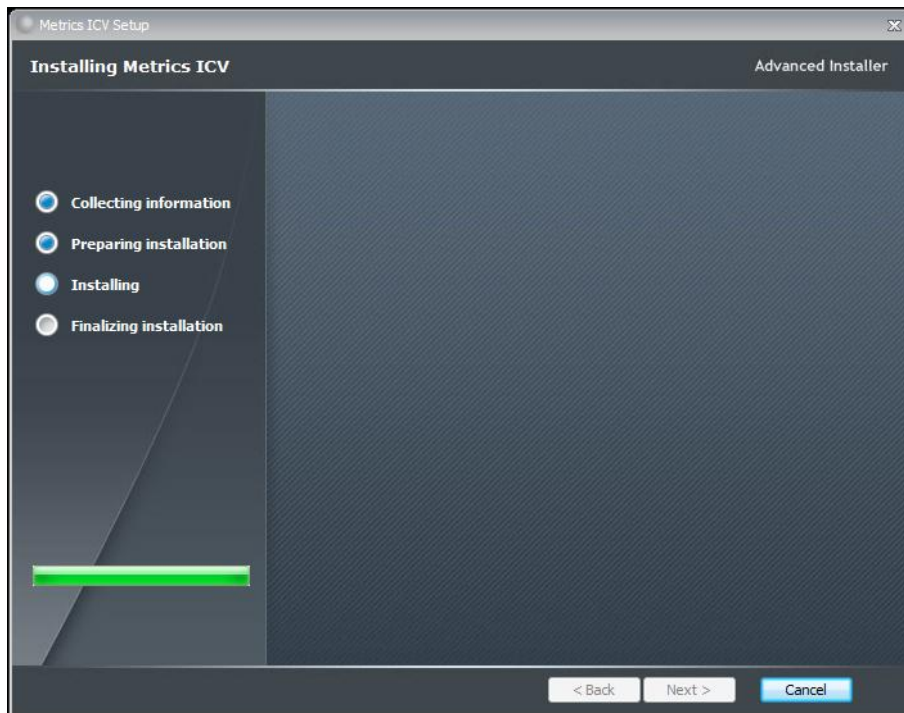

13. Allow the Metrics ICV installation to complete.

14. Then click **Finish** to complete the installation.

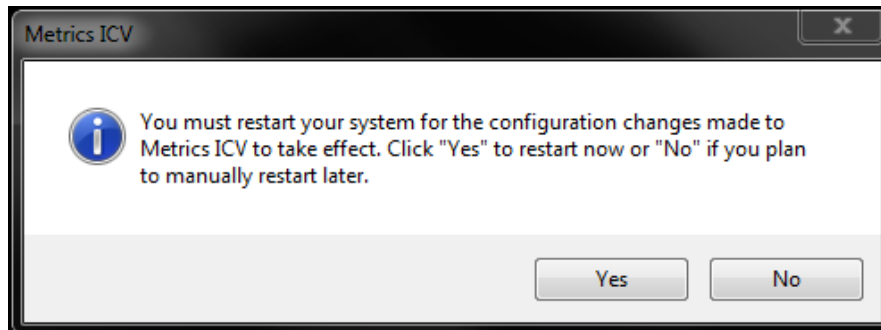

15. After the installation is finished, re-start the computer.

Metrics Codewords

Metrics Technology software products use a combination Node Locked license model which includes the generation of a hardware fingerprint for the workstation PC and a Codeword. The unique combination of a Codeword and license.v2c file allows the software product to be run on a single workstation PC for which the license has been activated.

Software Codeword Information

There will be a codeword for each software component ordered. This information is made up of two (2) parts, the Registration Information and Codeword Information. We encourage all customers to register their software with Metrics Technology. Only registered users will receive technical support for their products.

License Number

The License Number is a number that has the form IAXXXXXA. Where the X is a number. Variations include IHXXXXA, MHXXXXA, and MKXXXXA. This number must match the number on the Security Key.

Product Desc

This is the Product Description. This will be the name of the product, such as Metrics ICV or Metrics ICS.

Product ID

The product ID is MTICV or MTICS and should be entered in the ID field

Version

This is the version of the software i.e. 4.5.0

Note: The version number and the codeword are matched. Thus, customers who have not purchased an upgrade will not be able to run it without purchasing the correct codeword.

Codeword (Example)

AYJE6-AKXMP-HXGCK-HMK4R-I2HAB-U3AT6

Note: The software Codeword number for ICS should be entered in each application (ICV and ICS) separately.

Activate the ICV License:

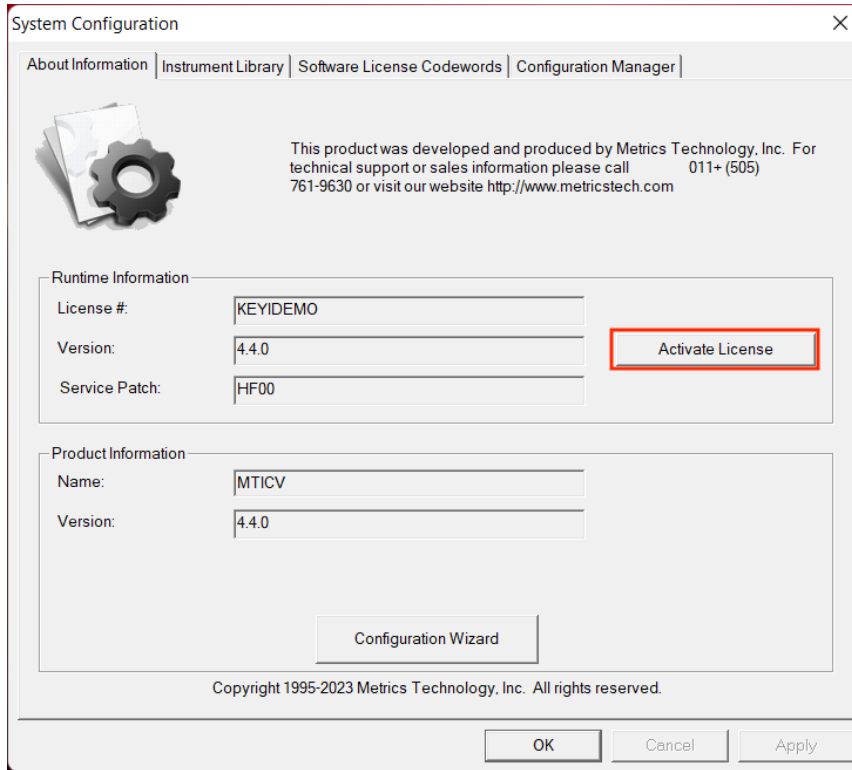

1. Go to System->Config About Information tab and then click the "Activate License" button.

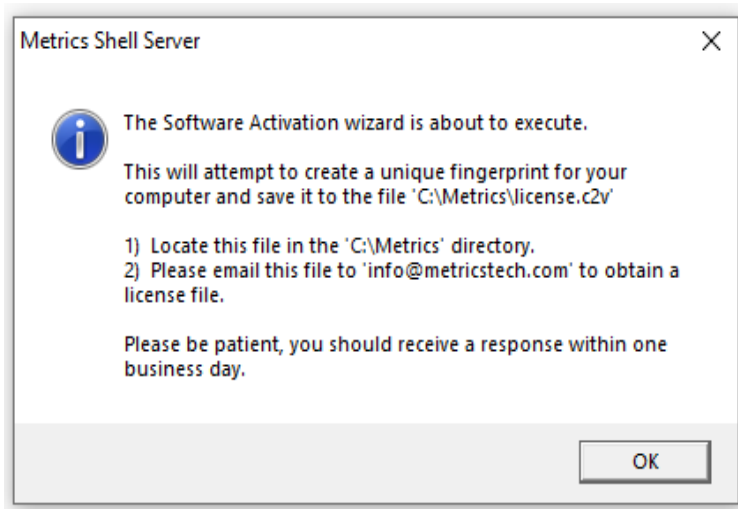

2. A message will be display from the Software Activation Wizard. Click the "OK" button in the dialog.

3. A file named **license.c2v** (Customer to Vendor) will be created in the **C:\Metrics** directory.
4. Email this file to "info@metricstech.com" as an attachment.

Note: You should make sure the workstation PC that you are activating the software license for is the one that you intend to node lock the license to. You can transfer the license in the case of a hardware failure or when purchasing a new computer but the transfer is restricted and limited to only a one time update.

5. Customer Service will create another file named "<YourLicenseNumber>_license.v2c". This is the (Vendor to Customer) file and will be emailed back to you. (For example: IA54999A_license.v2c)
6. Copy this file to the **C:\Metrics** directory and rename it to the abbreviated name **license.v2c**
7. Close ICV and restart

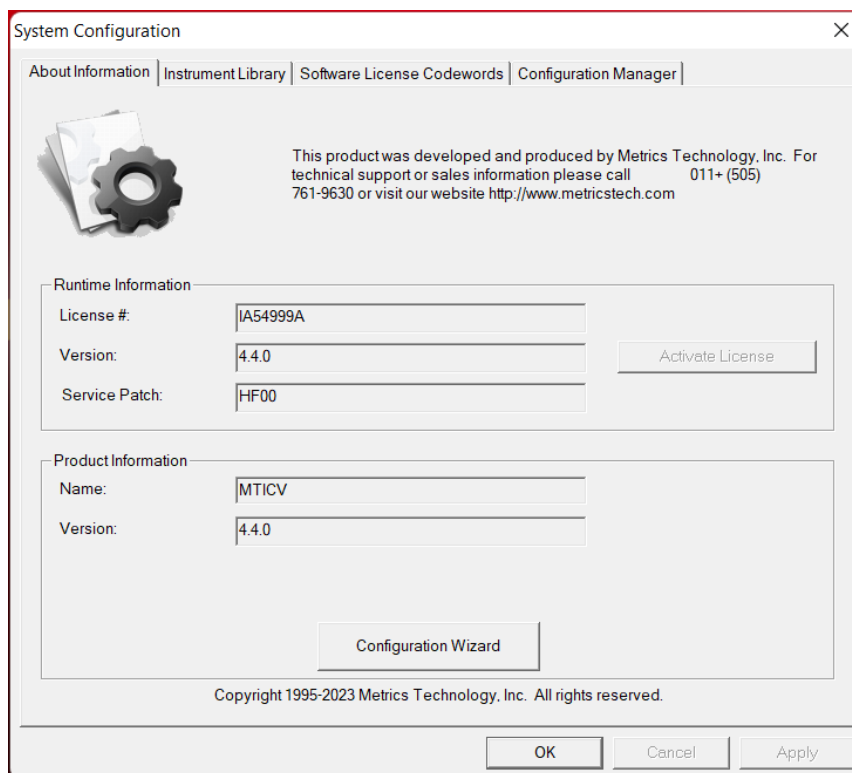

8. Open the System->Config About Information tab and verify the license number is displayed properly.

Enter the Codewords

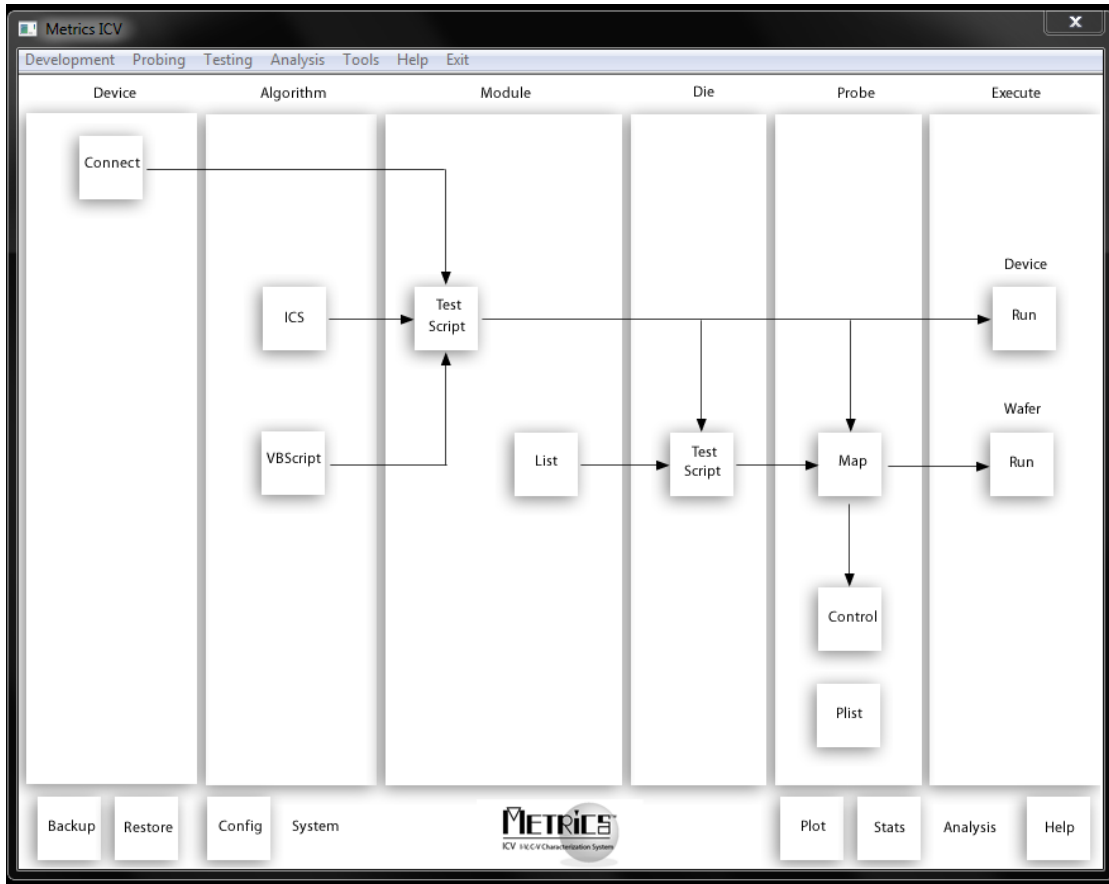

1. Start Metrics ICV to display the system window.
2. Open the *System Configuration* window by selecting **Tools » System Configuration** or click the **Config** button.
3. Click on the "Software License Codewords" tab

Note: This tab will open automatically if no codewords have ever been entered. You will receive a warning message to enter codewords the first time you start Metrics ICV. Please follow the instructions below to enter your codewords.

Note: It is recommended that you cut and paste the codeword from the registration e-mail or certificate sent from Metrics Technology Customer Service. Be careful not to include any space before or after the code word string.

If typing the codeword from the keyboard be careful not to transpose letters or numbers. The letter I can be confused for the number 1 and the letter O can be mistaken for the number 0

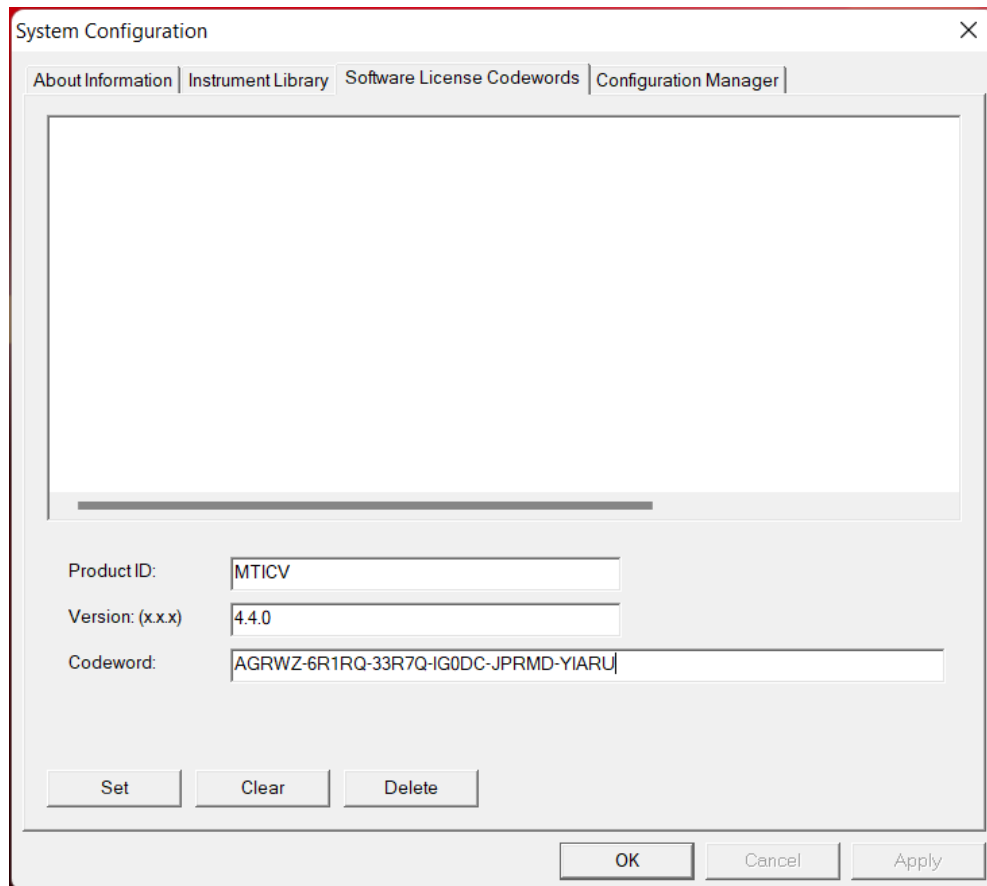

4. Enter the Product ID, Version, and Codewords supplied on the product registration certificate or e-mail.

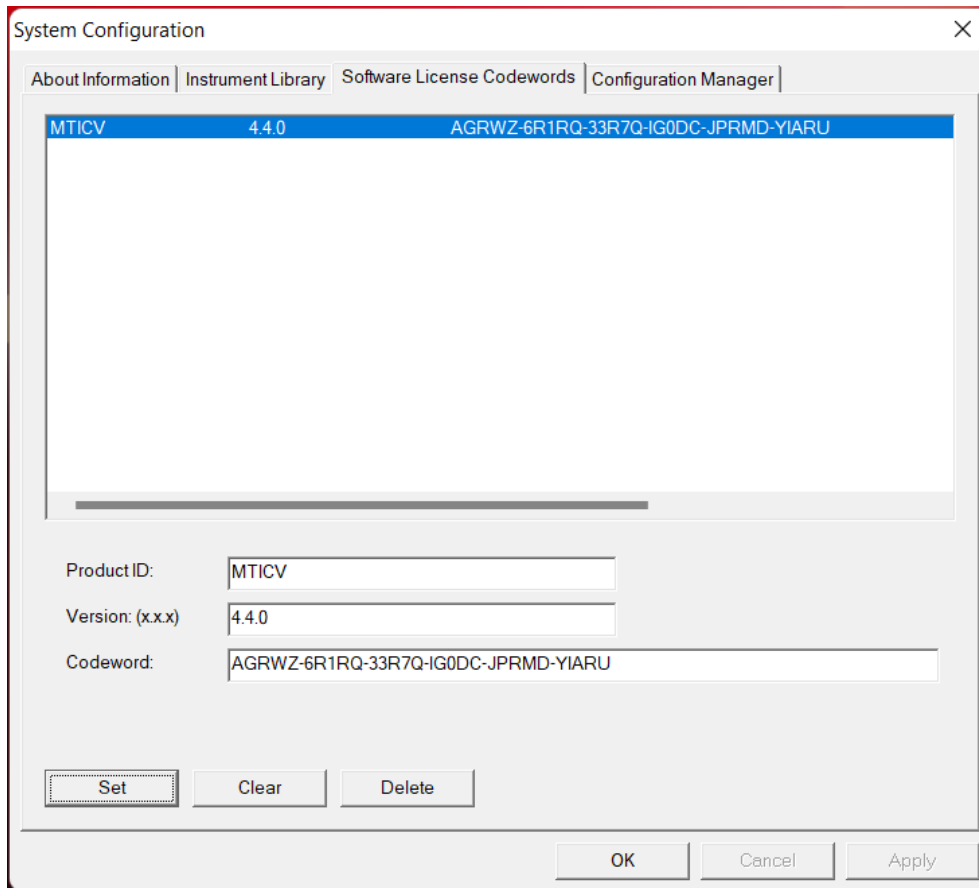

5. Enter the ICV codeword information. Click the **Set** button.

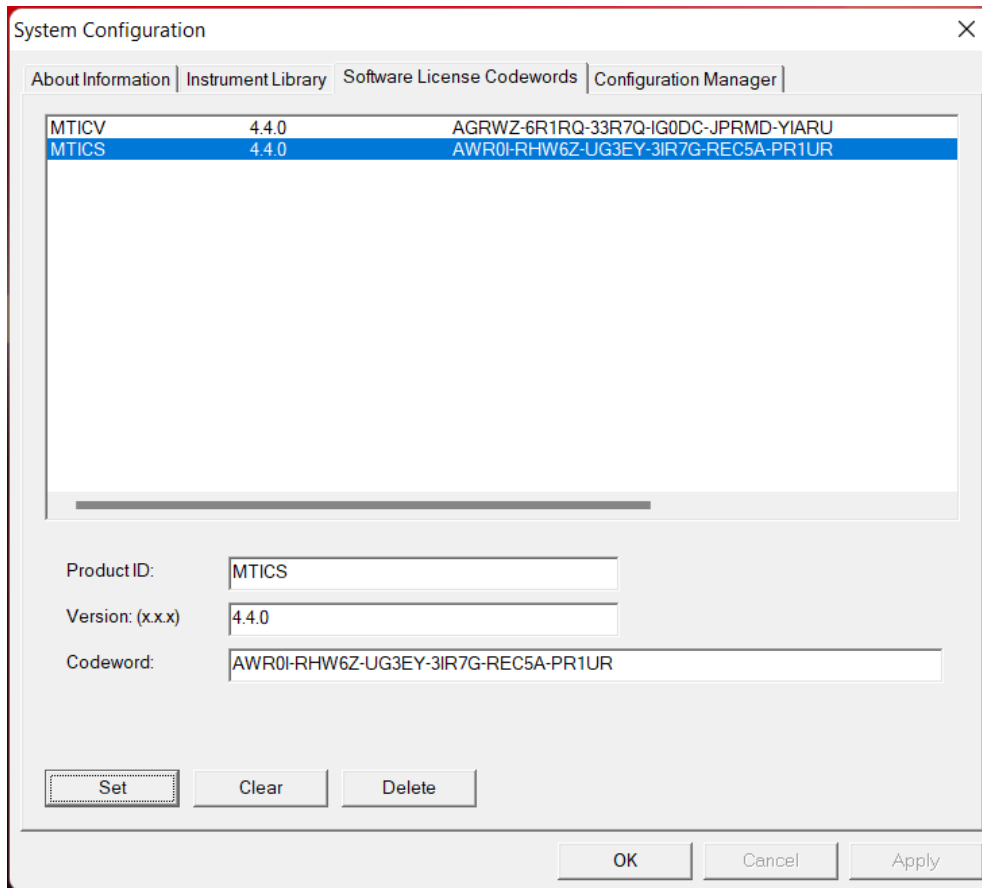

6. Enter the ICS codeword information. Click the **Set** button.

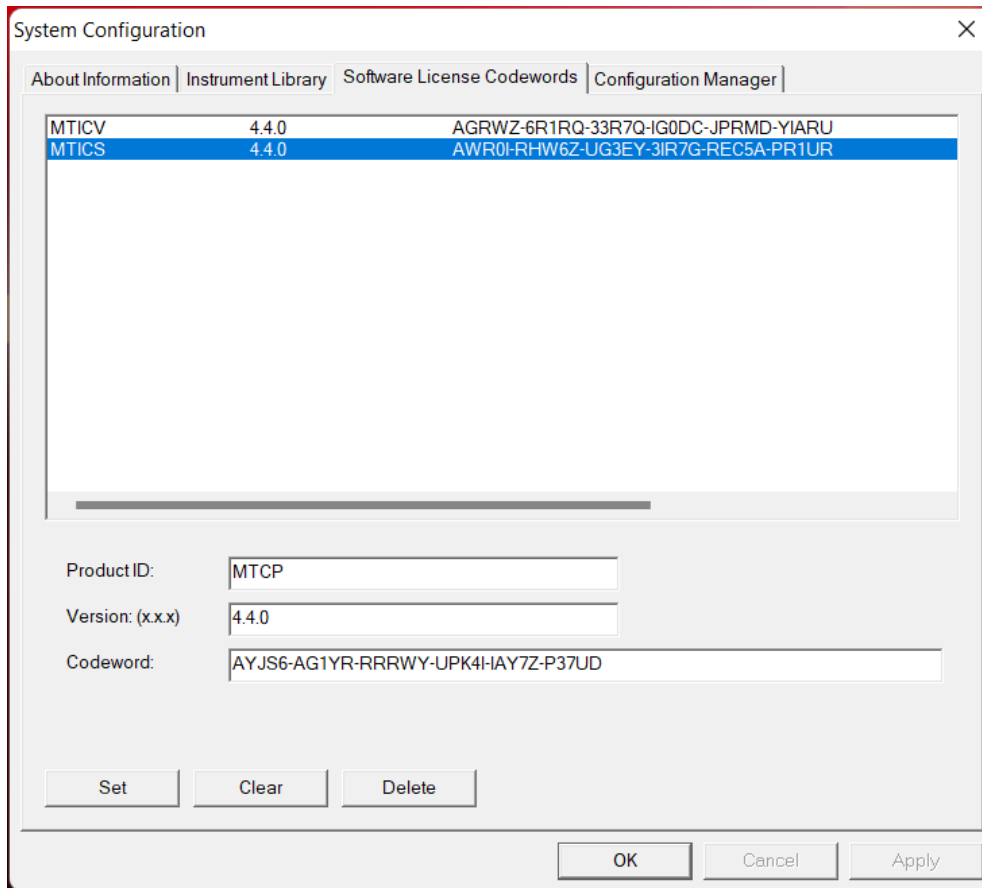

7. Enter the IDE codeword information (optional). Required only if you have purchased the optional Integrated Developer Environment product.
8. Click the **OK** button to close the System Configuration dialog.

Note: You need to enter the ICS codeword again in the integrated Metrics ICS program. See the information below for performing this important step.

To Enter the ICS Codeword

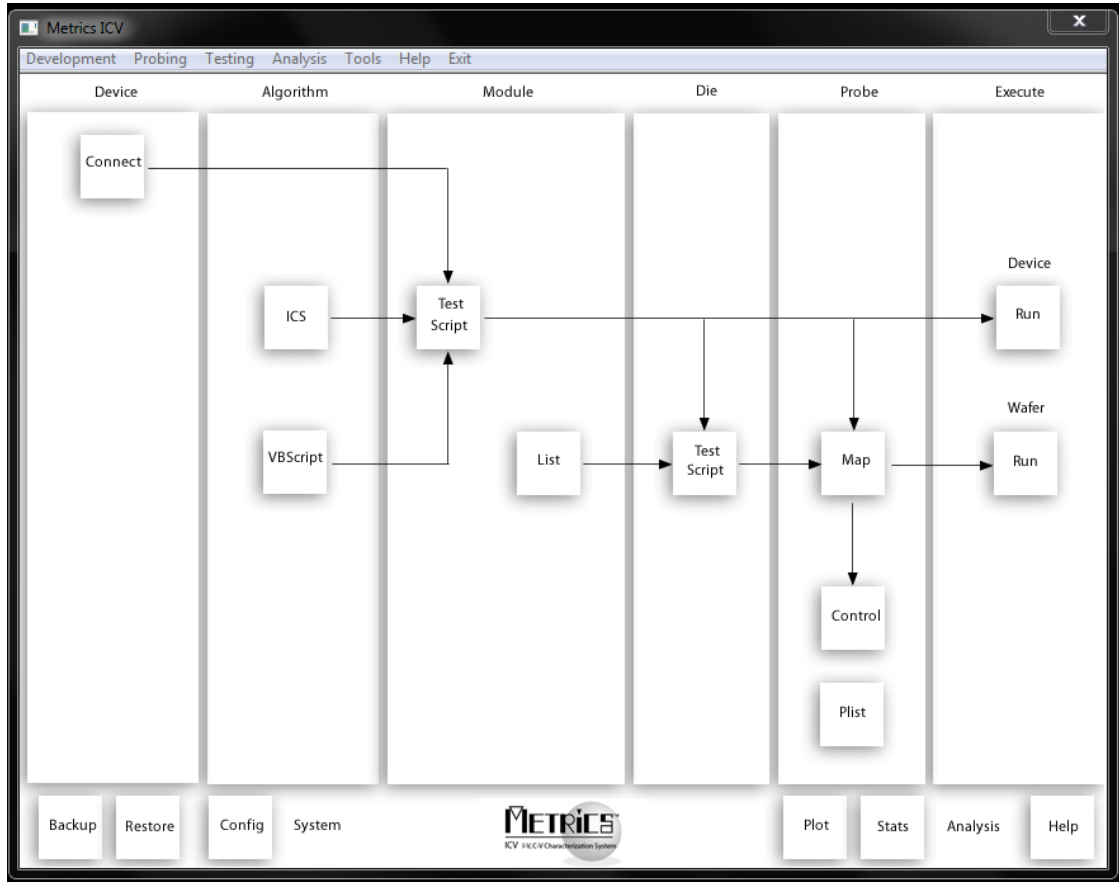

1. Open the Metrics ICS program by selecting the ICS button under Algorithm.
2. Select the ICS menu item **Help » Codeword** to open the *Software License Codeword* dialog.

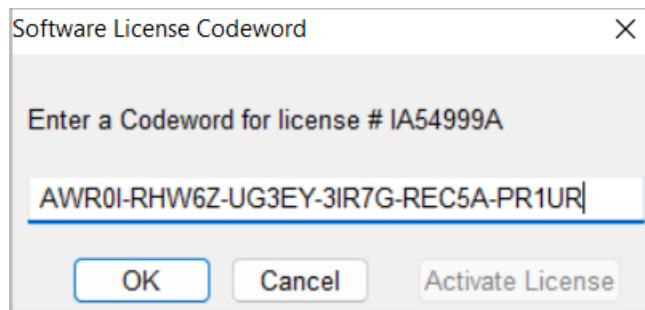

3. Enter the ICS Codeword supplied via e-mail or on the product registration certificate.
4. Click the **OK** button.

Configuring ICV

Probe Station Configuration

After installing Metrics ICV, it must be configured. The first time ICV is started, it will automatically run the Configuration Wizard Utility. This utility will ask the operator a series of questions to determine the correct configuration for the probe station drivers of the Metrics ICV software.

Start the Configuration Wizard, follow these steps:

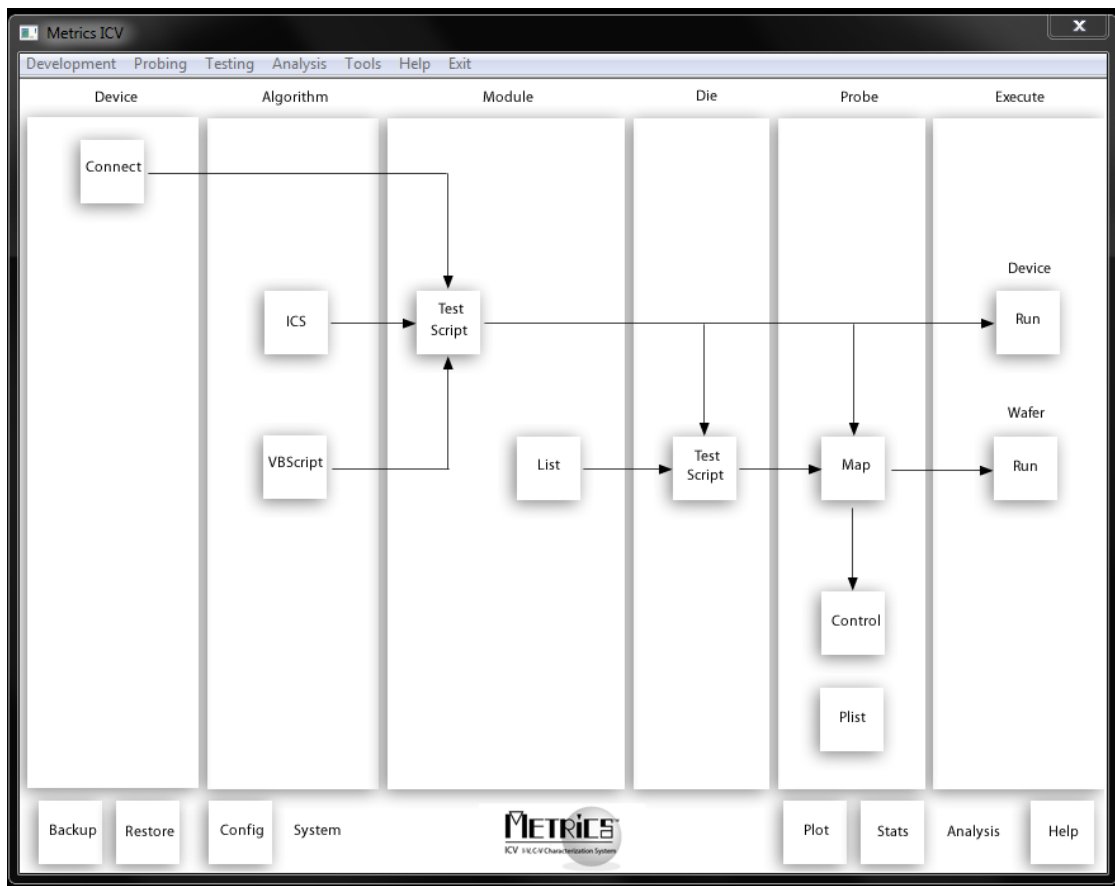

1. Open the *System Configuration* window by selecting **Tools » System Configuration** or clicking the **Config** button.

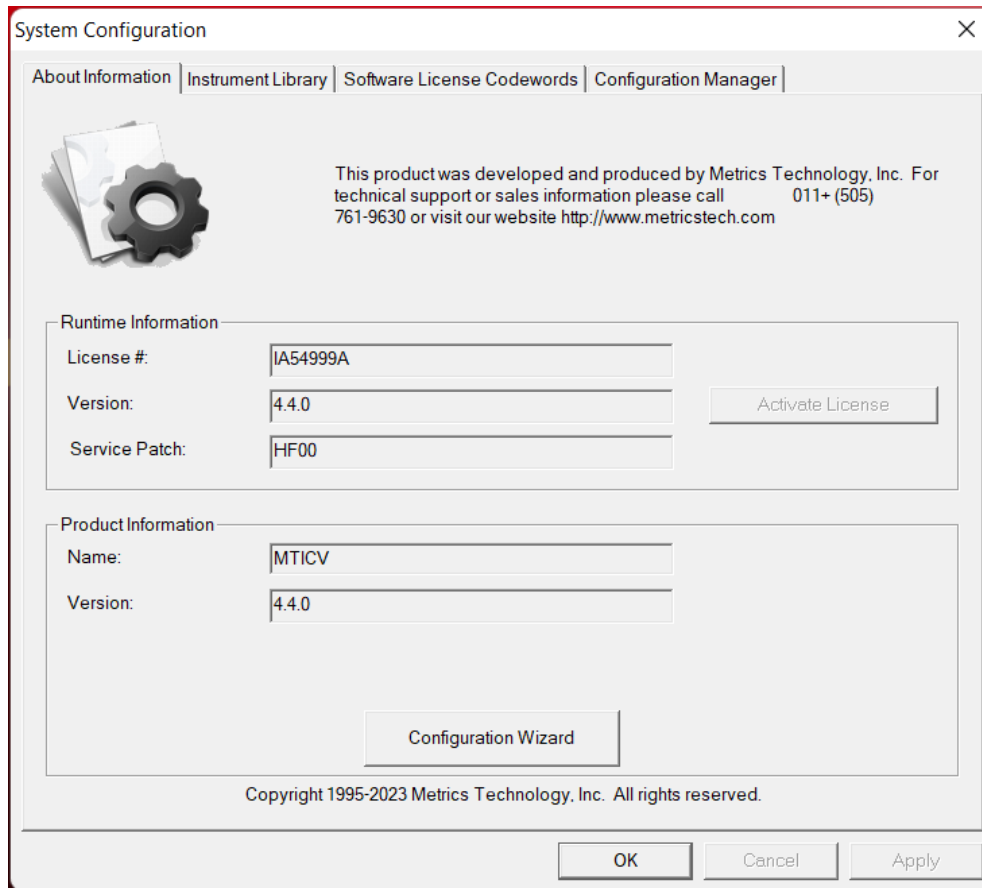

2. Click on the **Configuration Wizard** button found on the "About Information" Tab.

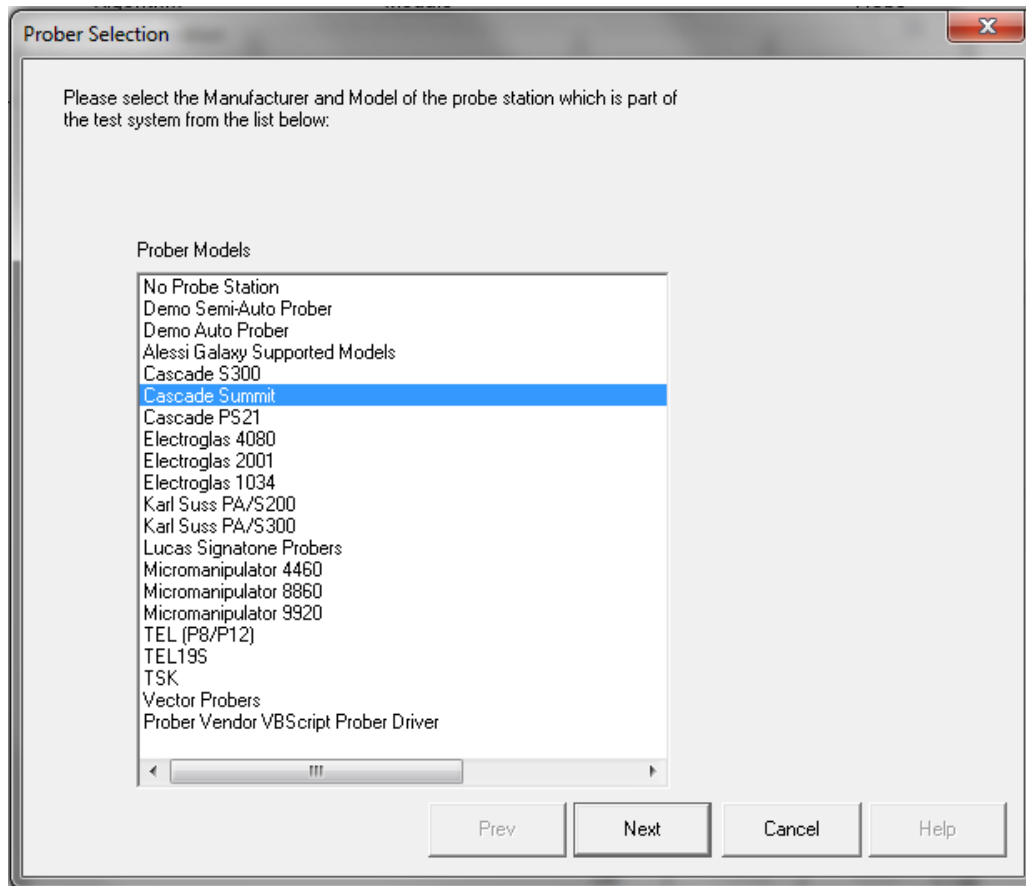

3. Select the Probe Station you are using then click **Next**.

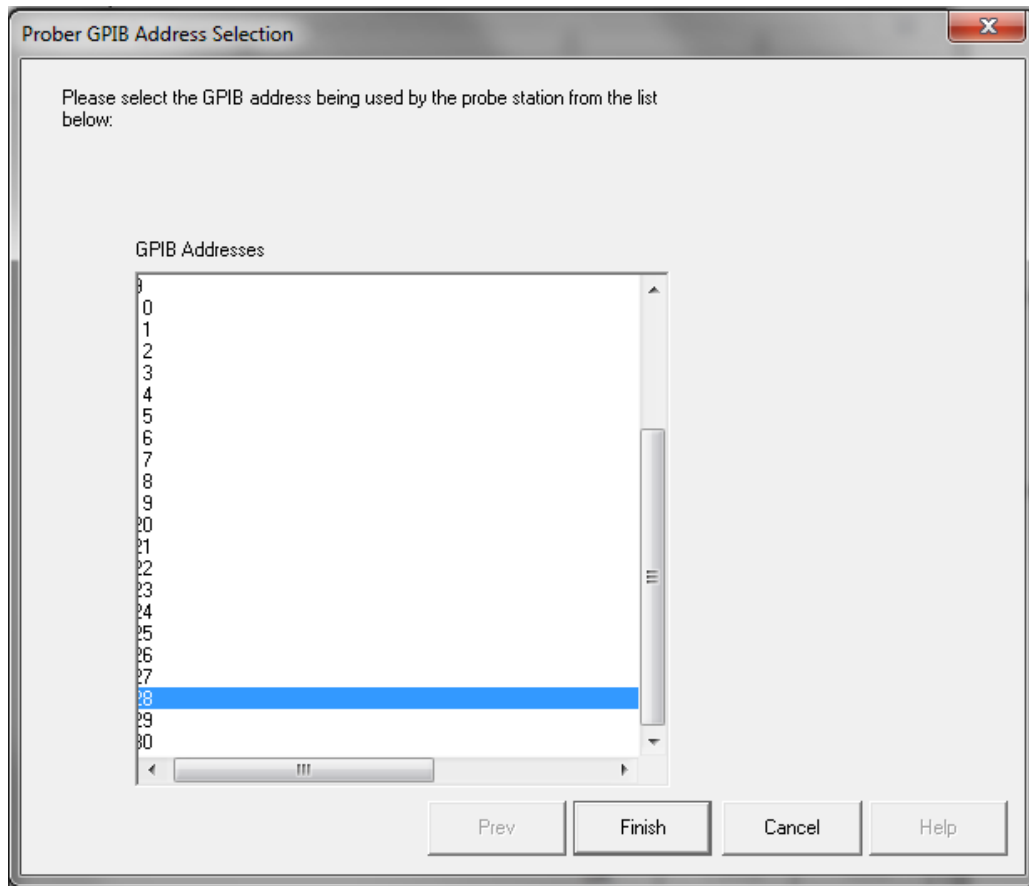

4. Provide the GPIB address of the station then click **Finish**.

Instrument Configuration

The Configuration Wizard Utility will setup the probe station information, however typically other components must also be setup in order to run the testing. These components are setup manually by the user the first time the system is run. These configurations are then saved and automatically loaded each time the software is started.

Instrument Library

The Metrics ICV Instrument Library contains setup information for the instruments used by:

- The Device Connection Control (Switch Matrix).
- Instruments used by the Metrics ICV supplied algorithms.
- Probe Station Control.

Switch Matrix Configuration

Version 4.5 of Metrics ICV has completely integrated the Switch Matrix Control within ICV. Therefore, the configuration of a switch matrix is now provided within the Metrics ICV System Configuration.

The screenshot shows the 'Instrument Definition' dialog box. It has a title bar with a close button. The main area is divided into three sections: 'Instrument Definition', 'Communications Setup', and 'Communications Verification (Not Required)'. The 'Instrument Definition' section has four fields: 'Name' (text box with 'SW1'), 'Description' (text box with 'Switch Matrix'), 'Group' (dropdown menu with 'Switch'), and 'Driver' (dropdown menu with 'siat5250'). The 'Communications Setup' section has two fields: 'Physical Interface' (dropdown menu with 'Unified GPIB (GPIB)') and 'Primary Address' (text box with '22'). The 'Communications Verification (Not Required)' section has an 'ID Query Command' text box, a 'Verify' button, and two checkboxes: 'Append CR/LF to Query Command' and 'Read Query Response'. At the bottom of the dialog are four buttons: 'Prev', 'Next', 'Cancel', and 'Help'.

1. Click the **Add** button to open the *Instrument Definition* window. Enter the following:
 - a. **Name**- A unique name that identifies the instrument.
 - b. **Description (optional)**- Additional description of the instrument.
 - c. **Group**- Select “Switch” from the pull-down list.
 - d. **Driver**- Select the driver for your instrument from the list.
 - e. **Physical Interface**- Select the GPIB device you will connect to the switch matrix through.
2. **Primary Address**- Enter the GPIB address of the switch matrix.

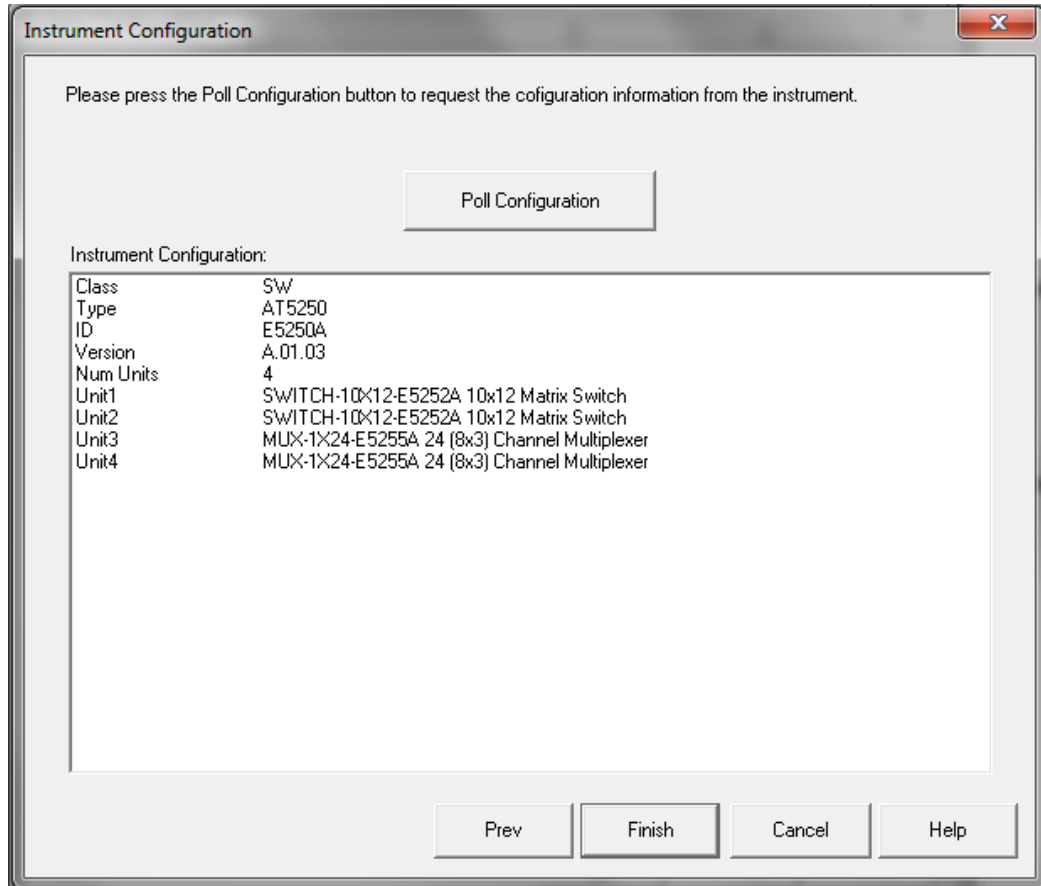

3. Click the **Next** button to open the *Instrument Configuration* window. Confirm the instrument is connected to the GPIB bus and click the **Poll Configuration** button.
4. Click the **Finish** button to complete the addition of the switch matrix.

Instrument (SPA, CMU) Configuration

Metrics ICV Version 4.5 includes a collection of pre-written test algorithms. These algorithms control selected CV and IV instruments. These instruments must be configured in this section.

Note: If you are using ICS with other drivers you will need to configure the instrument in that Tool as well.

The screenshot shows the 'Instrument Definition' dialog box. It has a title bar with a close button (X). The main area is divided into three sections:

- Instrument Definition:** This section contains a text box for 'Name' with the value 'SPA1', a text box for 'Description' with the value 'Semiconductod Parameter Analyzer', a dropdown menu for 'Group' set to 'Instrument', and a dropdown menu for 'Driver' set to 'iiat415x'.
- Communications Setup:** This section contains a dropdown menu for 'Physical Interface' set to 'Unified GPIB (GPIB)' and a text box for 'Primary Address' with the value '17'.
- Communications Verification (Not Required):** This section contains a text box for 'ID Query Command', a 'Verify' button, and two checkboxes: 'Append CR/LF to Query Command' and 'Read Query Response', both of which are unchecked.

At the bottom of the dialog are four buttons: 'Prev', 'Next', 'Cancel', and 'Help'.

1. Click the **Add** button to open the *Instrument Definition* window. Enter the following:
 - a. **Name-** A unique name that identifies the instrument. If you will be using the ICV algorithms provided by Metrics Technology, you MUST name the parameter analyzer “SPA1” and the Capacitance Meter “CMU1”.
 - b. **Description (optional)-** Additional description of the instrument.
 - c. **Group-** Select “Instrument” from the pull-down list.
 - d. **Driver-** Select the driver for your instrument from the list.
 - e. **Physical Interface-** Select the GPIB device you will connect to the switch matrix through.

2. **Primary Address-** Enter the GPIB address of the instrument.

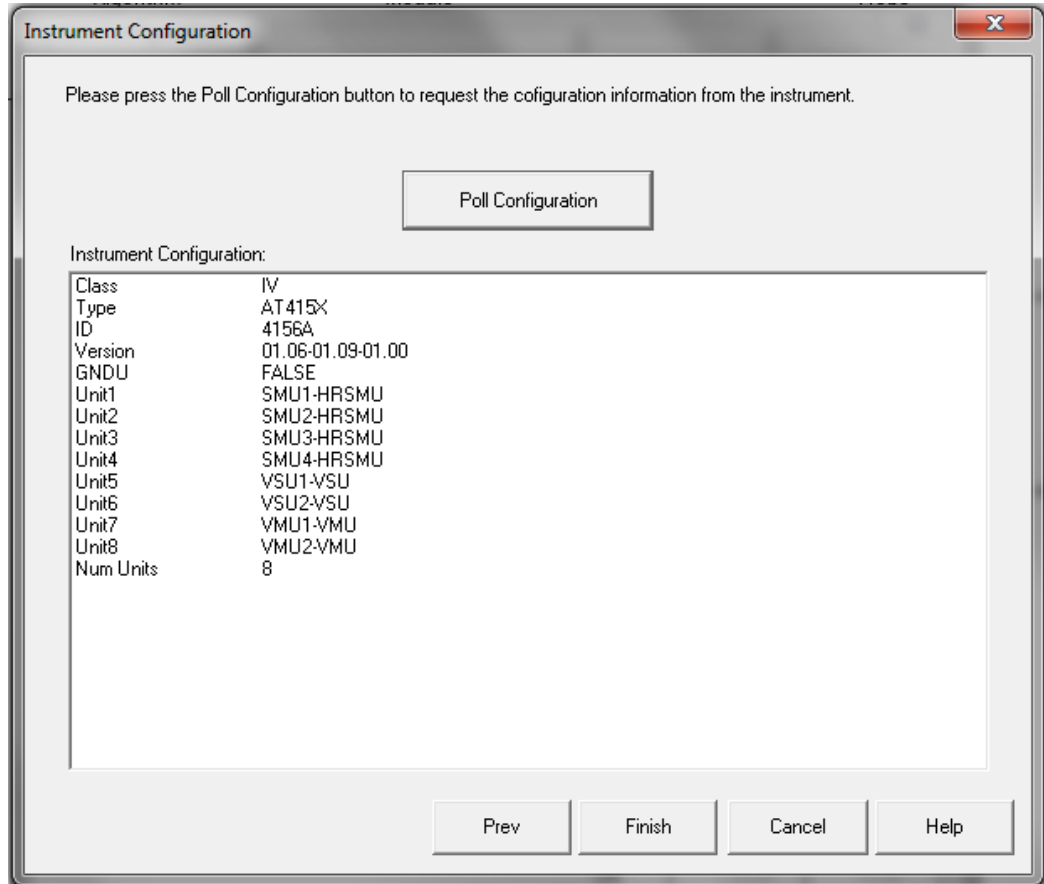

3. Click the **Next** button to open the *Instrument Configuration* window. Confirm the instrument is connected to the GPIB bus and click the **Poll Configuration** button.
4. Click the **Finish** button to complete the addition of the instrument.

Note: The communications server includes the driver "Unified GPIB" for supporting both legacy GPIB communications and also LXI (TCP/IP) communications for instruments that support these types of interfaces. The "Unified GPIB" can and should be used to communicate with legacy GPIB only instruments.

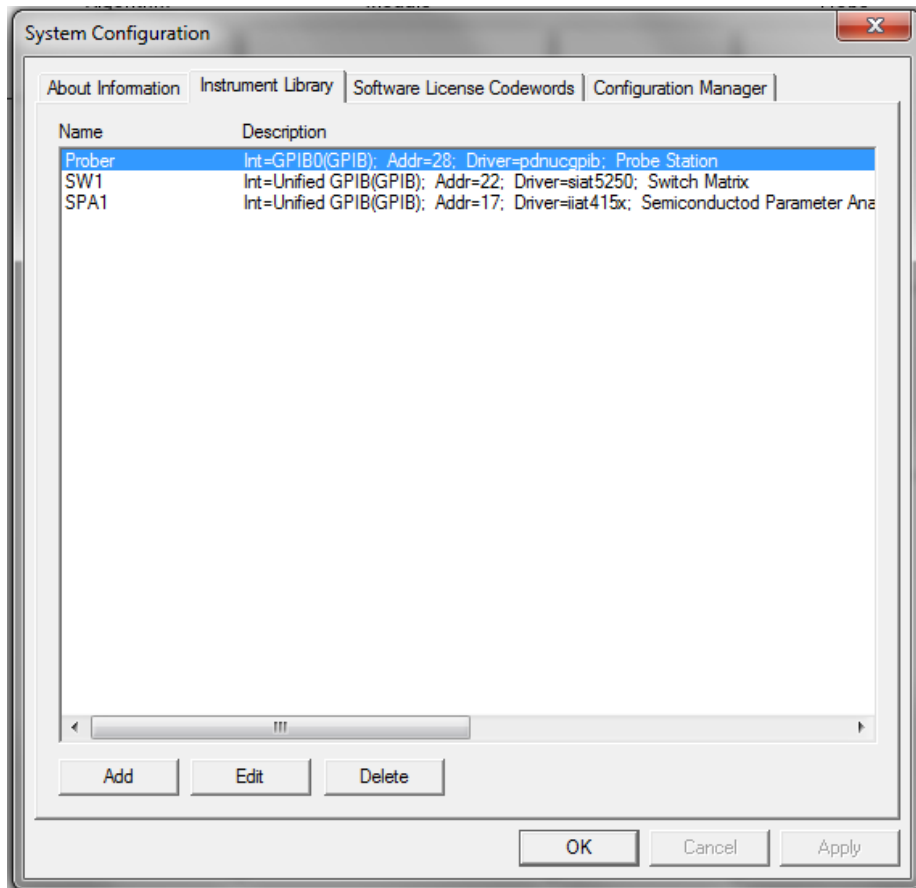

5. Click **OK** to close the Instrument Library configuration.



ICV Getting Started Guide

Metrics ICV

Version 4.5

© Copyright 1999-2026, Metrics Technology, Inc. All rights reserved.

Introductory Information

Goal of This Manual

The goal of this manual is provide a process for the user to be able to create a test plan with Metrics ICV. A test plan will be created that tests two devices in the same module structure. This plan will be executed across a wafer. The plan will then be modified to execute this testing at several sub-die locations within each die.

The definition of the terms wafer, die, module, algorithm, and script will be presented to demonstrate how they are used in this product and manual. In many cases certain terminology used within this manual may have a direct correlation to another term used within a specific company.

Chapter 1- ICV Getting Started Guide

Introduction

The first chapter of this self-paced "Getting Started Guide" introduces the Metrics ICV software. This chapter also provides important information on software versions and support.

Please note that each chapter builds upon the information presented in the previous chapters. It is recommended that the material is followed in the order presented.

Topics Covered

- What is Metrics ICV Software?
- Overview of Metrics ICV Software
- Updating Versions
- Support

What is Metrics ICV Software?

The Metrics ICV Software is a test executive designed specifically for semiconductor characterization and reliability applications. The environment is designed to be flexible so that different applications can be designed using the same system software. Customer applications range from incoming parts screening to full wafer test. All of this can be accomplished from one software environment while being required to write code either minimally or not at all.

Metrics ICV Controls:

- Semiconductor Parameter Analyzers
- C-V Meters
- Switching Matrixes
- Probe Stations
- Thermal Ovens and Chucks (with optional Integrated Developer Environment)

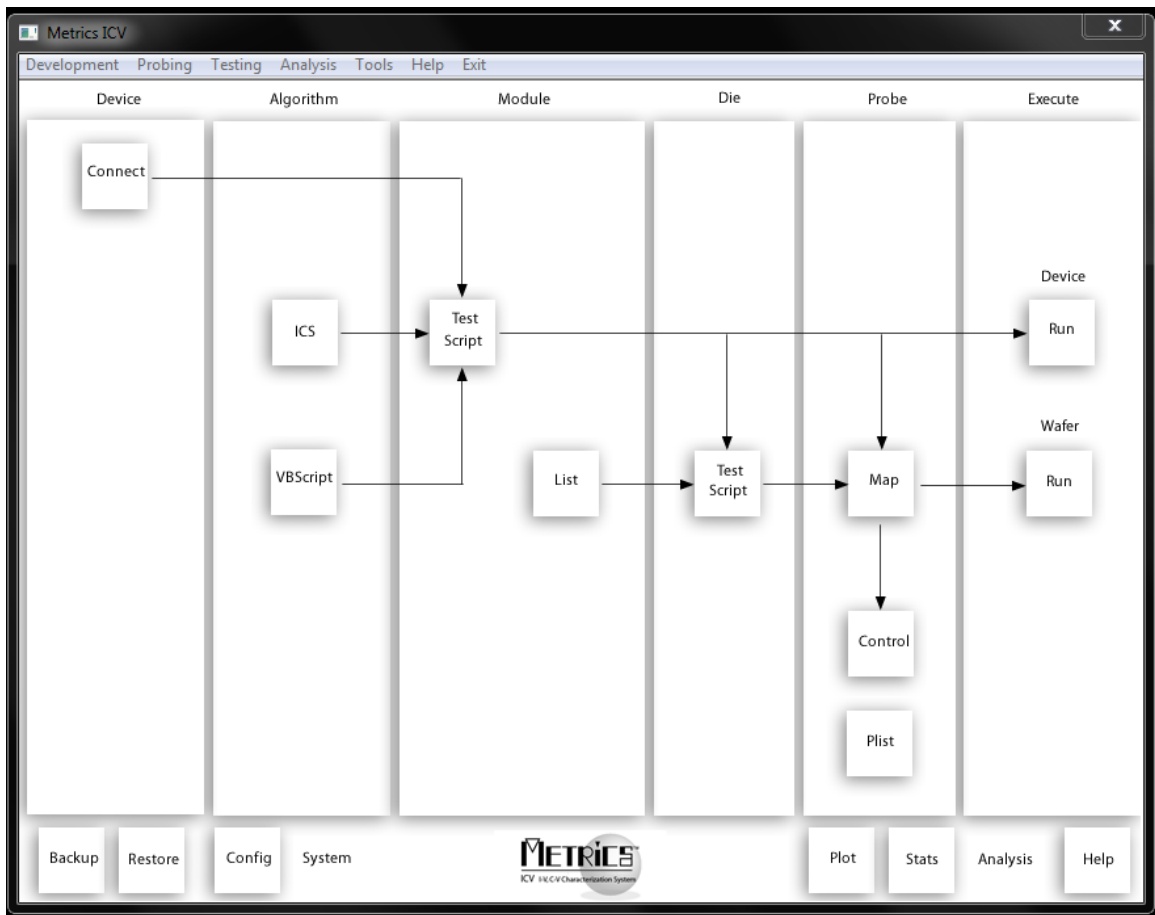

Overview of Metrics ICV Software

Metrics ICV software allows for the testing to be designed using several components. Each component can then be integrated into higher-level components. The components are the module script, die script, and wafer plan.

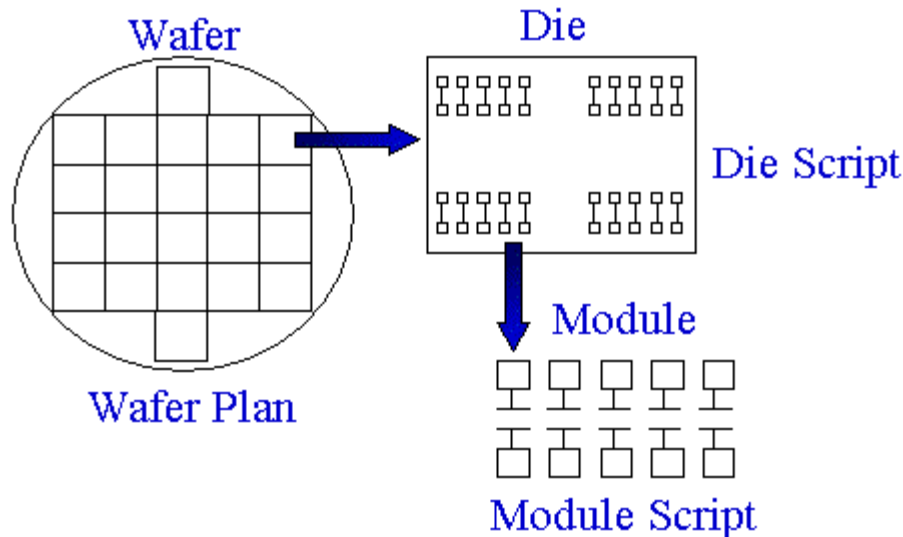

The **wafer plan** sequences the stepping of the probe station to each selected die. Once the probe station is at a selected die location, Metrics ICV runs the selected die script.

The **die script** sequences the stepping inside of a die and the module script to be executed at the location. Each location (module) to be visited within the die is listed in the die script. Metrics ICV steps to the Module location and calls the associated module script.

The **module script** allows for the creation and ordering of all tests that occur without moving the chuck or removing a part from the fixture. This typically includes the changing of switch connections and execution of different tests.

Note: At run-time the test engineer selects the wafer plan and test script to be run. This means that there can be many different die scripts and module scripts and the appropriate ones are selected as needed. Each script is stored independently.

Determining Software Version

The software version and HotFix number are very important when requesting support. Without this information it is impossible to provide efficient service. Please be prepared to provide this information when requesting support.

To determine the software version:

1. Open the ICV main window.

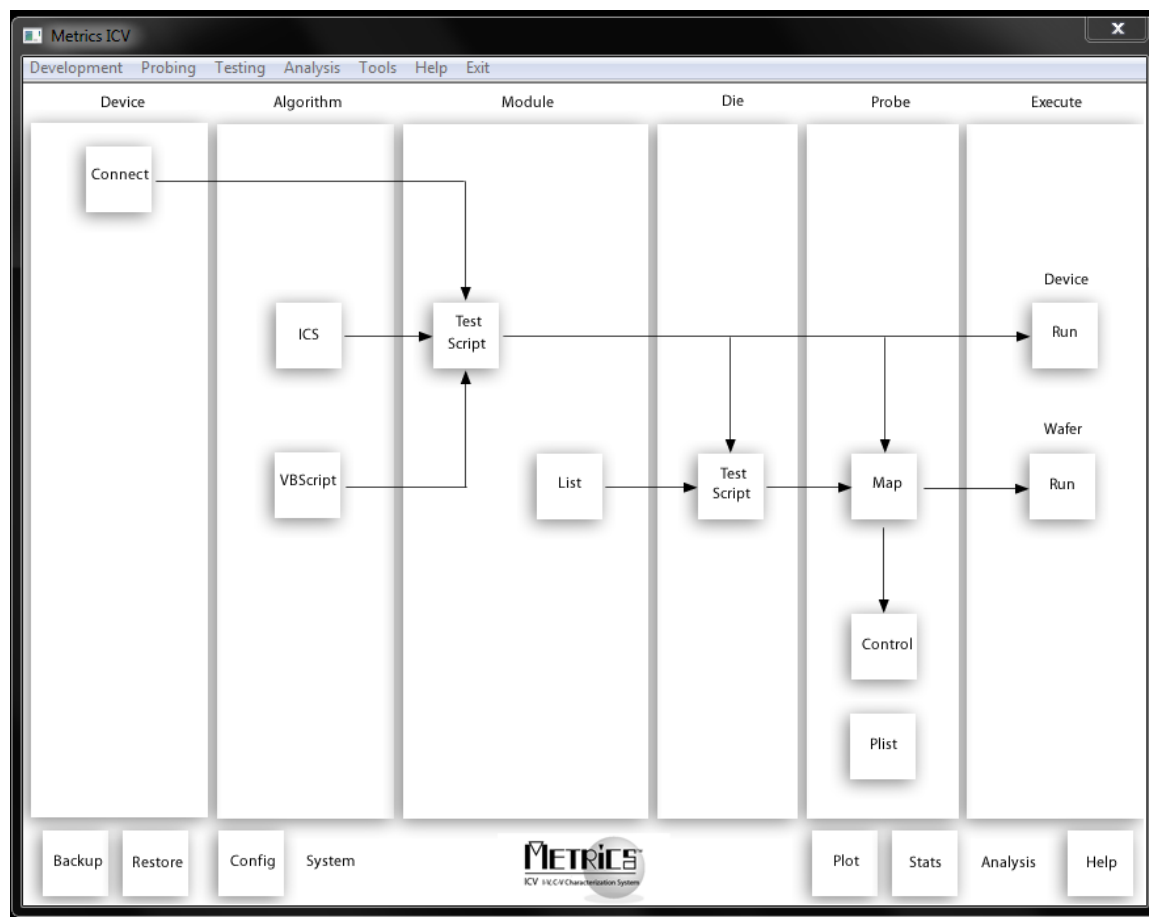

2. Select **Tools » System Configuration** or click the **Config** button.

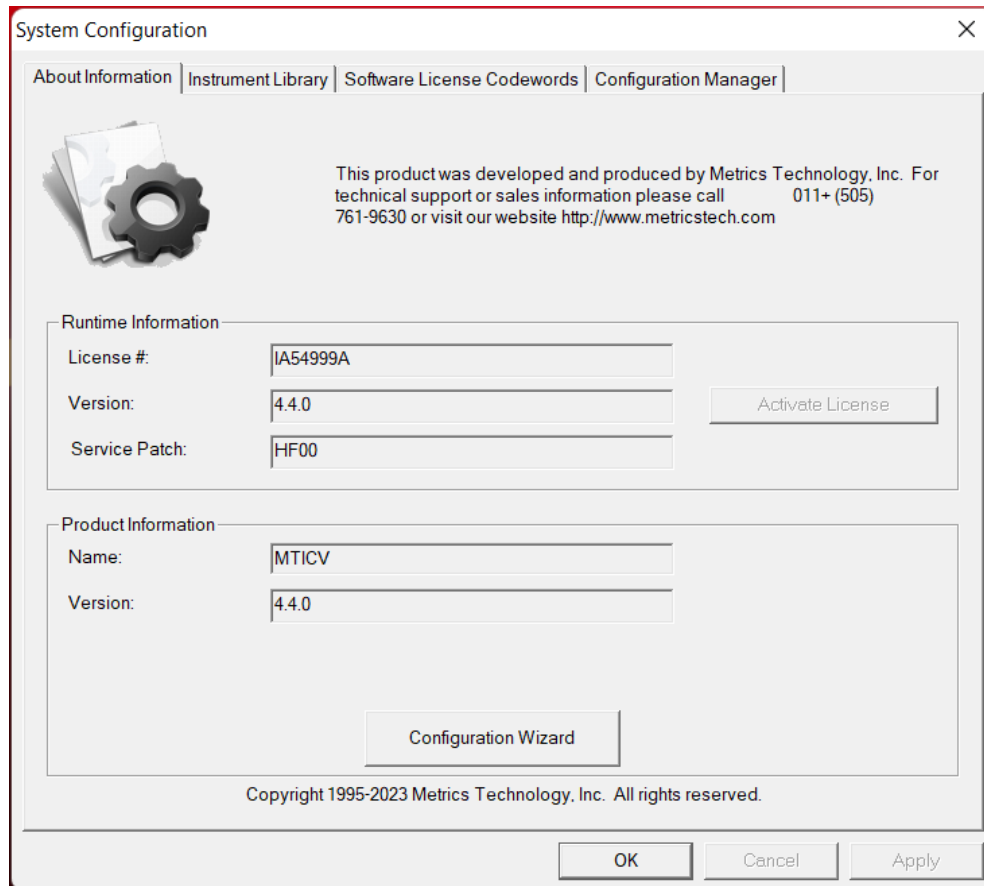

3. Click the "About Information" tab.

Updating the Metrics ICV Software

Please keep your software up to date by downloading and installing the Metrics Technology Hot Fixes. Your software will occasionally remind you to check for updated HotFixes. HotFixes are critical updates for any discovered defects. Often the issues addressed in the updates are ones that you may just now be encountering. The latest Hotfix contains all previous Hotfix resolutions.

Metrics Technology also provides a Service Pack when necessary. A Service Pack will contain all HotFixes and new program features. Once a Service Pack has been created and verified by Metrics Technology, it is placed on our website; www.metricstech.com. Please note the Service Packs are very large and will take time to download depending upon your connection speed. Once downloaded the file is an .EXE application.

Support

Metrics Technology provides technical support to customers for one year after the purchase of the Metrics software. This support period includes a ninety-day period when telephone support is available. The remainder of the year's support is provided by email. Information on how to set-up instruments can be found under the HELP tab of the software. Please visit our website at www.metricstech.com to register your software and obtain your log-in credentials. Your account will be activated within 24 hours.

If you are a customer that has registered and been provided log-in credentials you can access our Knowledge Base through your Customer Portal. If your issue is not addressed in the Knowledge Base it is most efficient to assist you if you submit a support ticket through your Customer Portal. Please provide the following information:

1. Your software License Number (also known as Customer ID (CID) / Registration number). The sequence will be IAXXXXXA, IHXXXXXA or MKXXXXXA, etc. (X represents a number).
2. Version of software and last HotFix applied. If you are using a currently supported version be sure you have applied the latest HotFix (HF##) available at our website accessed through your customer portal.
3. List of equipment you are using to test your devices.
4. The ICS project file or VBScript algorithms being executed.
5. Screen shots of the error code (Alt->Prt Scr, or Shift-Command-4 for MAC) to capture the error window. ***Images sent from a camera are often illegible.***

Chapter 2- Starting ICV

Introduction

The second chapter of this self-paced Guide will cover the Metrics ICV toolbar and the functions available. This chapter will also provide an overview of the steps required to create a test. Subsequent chapters will provide the details regarding test creation.

Topics Covered:

- The Metrics Program Group
- The ICV Toolbar
- Overview of Test Development

The Metrics ICV Program Group

When Metrics ICV is installed upon the system, a new program group and a desktop shortcut is created. The program group is called Metrics and can be found by clicking Start -> Programs -> Metrics. Inside the group are several links to different pieces of the Metrics ICV software. An example of the desktop shortcut that is created is displayed below. This shortcut will open the ICV navigation window.



The Metrics ICV Toolbars

Metrics ICV contains a single toolbar that is used for the creation and execution of tests. All of the tasks for creating the test and executing it are accessible from this window.

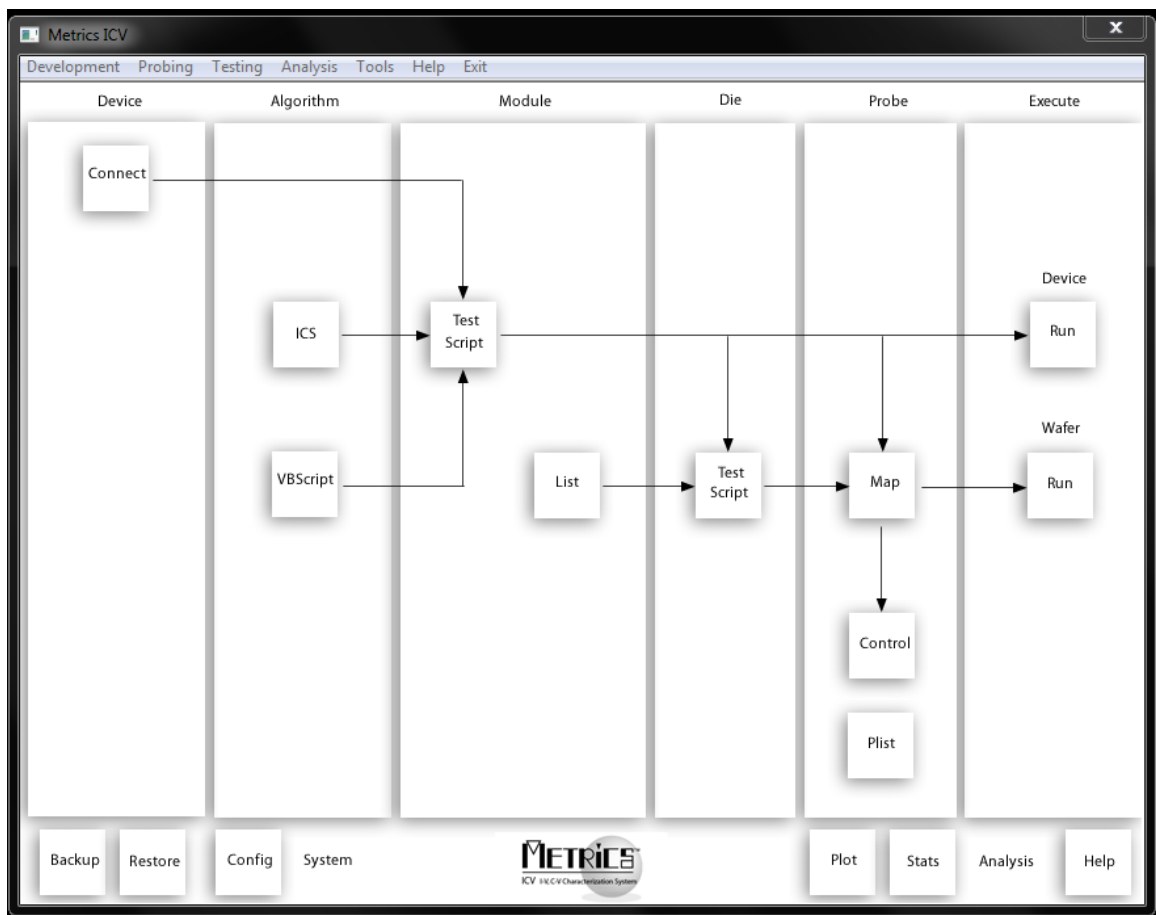

Metrics ICV Menus

The Metrics ICV navigation window has both menus and buttons on it. The menus contain shortcuts to the tools that are used with Metrics ICV.

Development Menu

When creating or editing a test, the Development menu is used. This menu includes access to the Device Connections Editor, Algorithms, Module Test Editor, Module List Editor, and Die Test Editor.

Probing Menu

The Probing Menu contains the applications needed to specify and test the wafer prober stepping control. These include the Wafer Map Editor, Probe List Viewer, and Prober Control.

Testing Menu

The Testing Menu contains one application, Run Test. This is the same as clicking the Run Test button on the Metrics ICV Toolbar. This will begin the process of running a test.

Analysis Menu

The Analysis Menu contains links to both the Data Browser and the Miner applications. The Data Browser allows the viewing of the raw data vectors. The Miner allows the creation of wafer maps of a Toolbar for starting them.

Tools Menu

The Tools Menu is a collection of applications for the maintenance of the system as well as other ancillary applications. These include Backup and Restore utilities, access to the System Configuration, and a link to the Metrics ICS tool which can be used to create algorithms.

Help Menu

The Help Menu is a direct link to open the online help manual. The Help button on the Metrics ICV Toolbar has the same function.

Metrics ICV Toolbar Buttons

The Metrics ICV Toolbar Buttons are the shortcuts to controlling and viewing test data.

Run Test Button

The Run Test button opens a dialogue box that allows the user to select the wafer plan, test script, and data location for the execution of a test.

Probe Control Button

The Probe Control button opens the Interactive Probe Station Control. This application provides an environment to confirm both that the probe station communication is working and the wafer plan setup is correct (die-to-die distances and module-to-module distances).

Plot Browsing Button

The Plot Browsing button opens an application that allows the plotting of data vectors from the wafer data collected.

Stats Analysis Button

The Stats Analysis button opens the Miner application. This application provides the capability to create and print histograms and wafer plans for the collected data.

Help Button

The Help Button is a direct link to open the online help manual. The Help menu on the Metrics ICV Toolbar has the same function.

Test Development in Metrics ICV

Test Development within Metrics ICV is a process of collecting the appropriate components together to perform a wafer test. These components include a wafer plan, module tests, die tests, and test algorithms.

A Top-Down Approach

When developing a test, a series of decisions are made. Looking at the information required from a top-down approach, the following list of questions is answered:

1. What wafer is to be tested?
2. What are the die size of the wafer?
3. What die locations do we want to test?
4. What module(s) do we want to test within the die?
5. What test scripts are run at each module?
6. If testing multiple modules, how far does the probe step to move between modules?
7. What devices do we want to test within the module?
8. What device pins are connected?
9. What tests do we want to run on the device?
10. How do the tests work?

Metrics ICV's Approach

By answering these questions, we have a very good idea of how the test should run. But how does this map to the Metrics ICV software? The information below provides a mapping of these functions.

Metrics Wafer Map Editor

The Metrics Wafer Map Editor provides the facilities for creating a wafer map which stores the information required to answer the questions.

- What wafer is to be tested? Each map can be named to represent a specific wafer and testing pattern.
- What are the die size of the wafer? Each map contains the X and Y die size.
- What die locations do we want to test? Each map contains the die that are selected to visit.

Die Test Editor

The Die Test Editor is a script generator that allows for the selection of the module locations to visit and the module script(s) to execute at the specific module.

- What module(s) do we want to test within the die?
- What test scripts are run at each module?

Module Test Editor

The Module Test Editor is a script generator that sequences the selection of devices within a single module and the tests to be run.

- What devices do we want to test within the module?
- What tests do we want to run on the device?

Module List Editor

The Module List Editor provides the facilities for defining the offset distances between modules within a die.

- If testing multiple modules, how far does the probe step to move between modules?

VB Script Algorithm Editor/ICS

The VBScript Algorithm Editor and/or Metrics ICS provide the facilities for defining the test methodologies for each device.

- How do the tests work?

Device Connections Editor

The Device Connections Editor is a graphical control for the switch matrix.

- What device pins are connected?

Below is a graphical representation of the components and how they relate to one another.

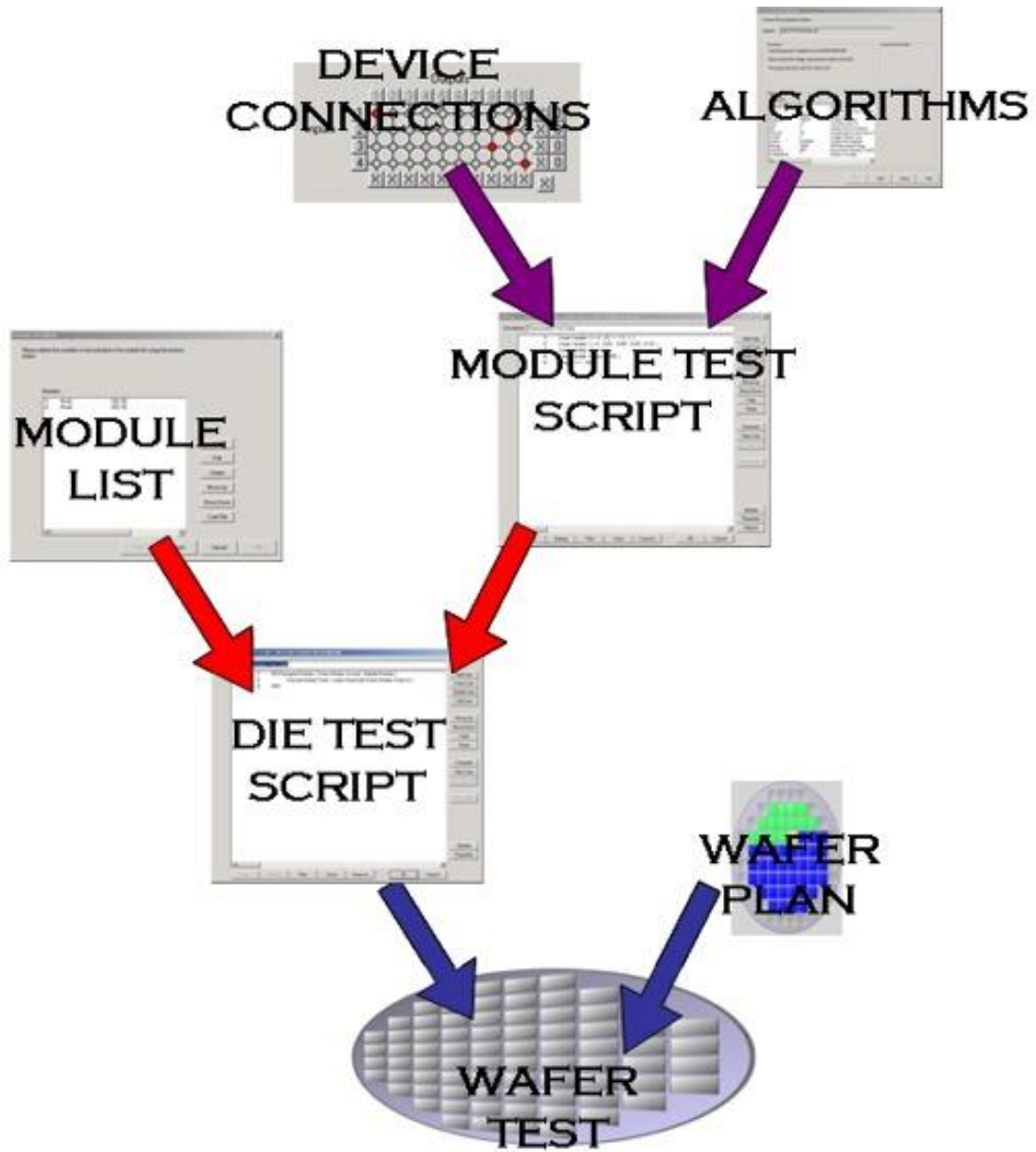

Chapter 3- Creating Device Connections

Introduction

The first step to creating the complete test plan is to configure device connections that allow the instrument to connect to the device. This is the case in systems that are using switch matrices and probe cards. If your system does not, skip this section and omit any switching control from further plan development.

This chapter details how to create device connection files and their use within Metrics ICV. The following instructions require that the switch already be configured according to the “Switch Matrix Configuration” section of this manual.

Topics Covered

- What is a device connection?
- Creating device connections
- Testing the connections
- Saving the device connection File

What is a Device Connection?

A device connection is the connection path that is made within the switching matrix. Typically the SMU or CMU is connected to the Input of the switch matrix. Typically the probe card or manipulators are connected to the output of the switch matrix. The device connection is the path that is made between input and output of the switch matrix.

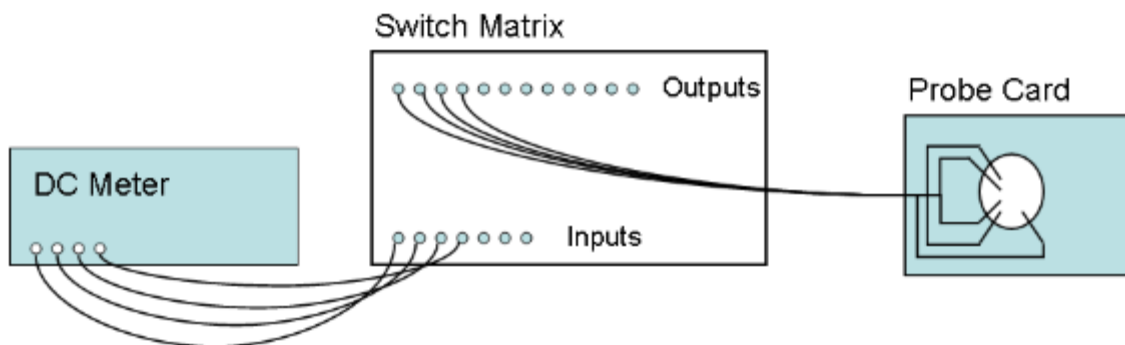

Creating Device Connections

Device connections are created within the Device Connection Editor. The editor is accessed by selecting Device Connections Editor in the Development Menu of Metrics ICV. At this point the goal is to create a collection of input/output connections that create matrix cross-points on the matrix cards that connect the source units with the pins of the device.

To Select Input/Output Connections:

Step 1: Select and name the Connection

1. Open the Device Connections Editor **Development » Device Connections Editor** or the **Connect** button.

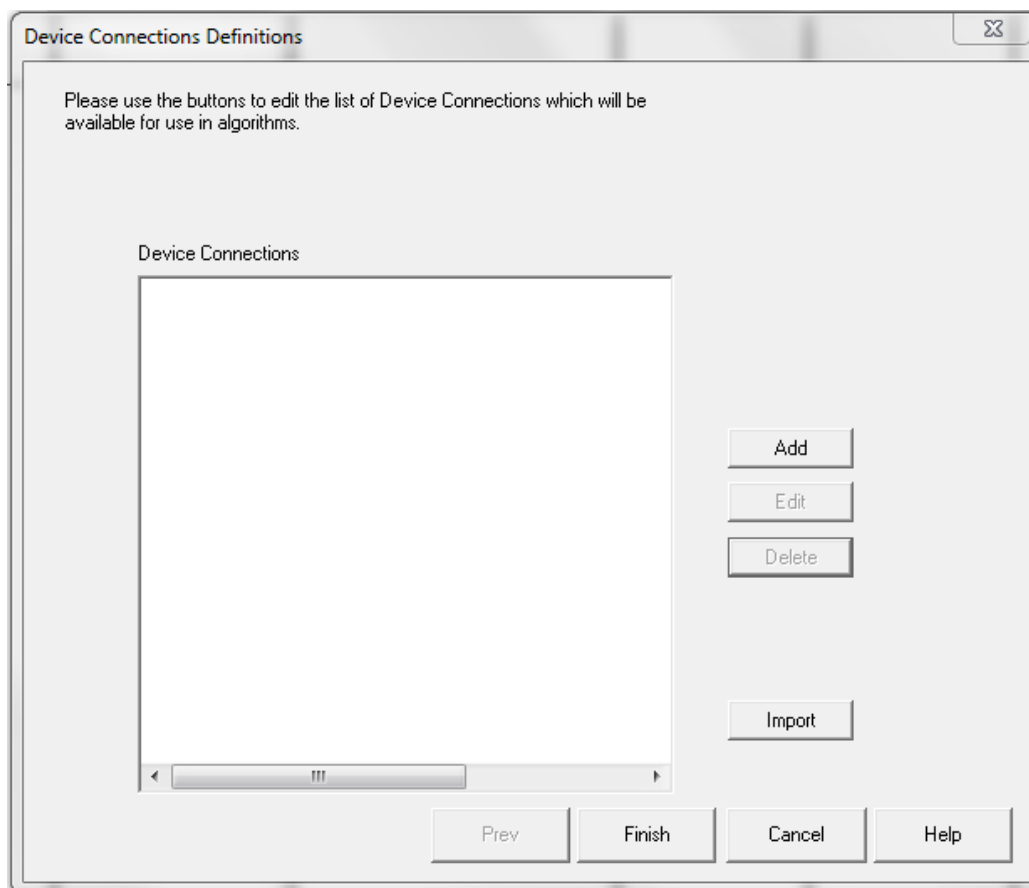

2. Click the **Add** button to begin the creation of a new Connection.

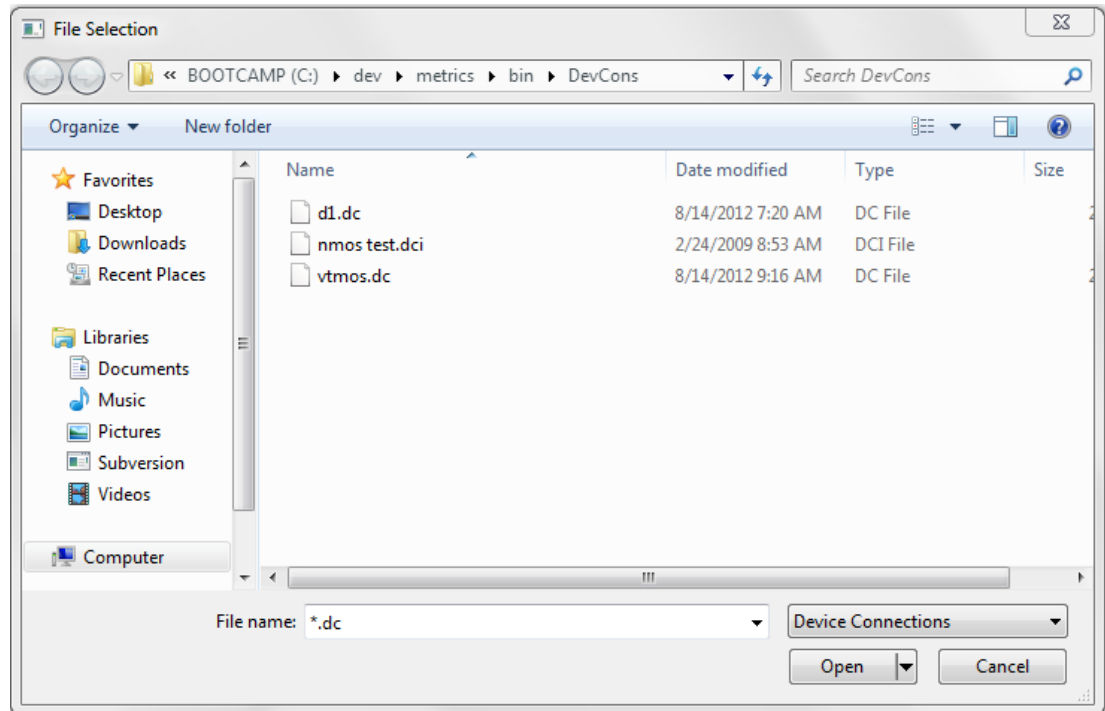

- Using the File Selection Control, enter a name for the connection in the File name field and click **Open**.

Note: Subdirectories can be created to group switch patterns based upon the module they are used within.

Note: Only switch patterns saved within the Metrics\DevCons directory will be saved when using the Metrics ICV Backup utility.

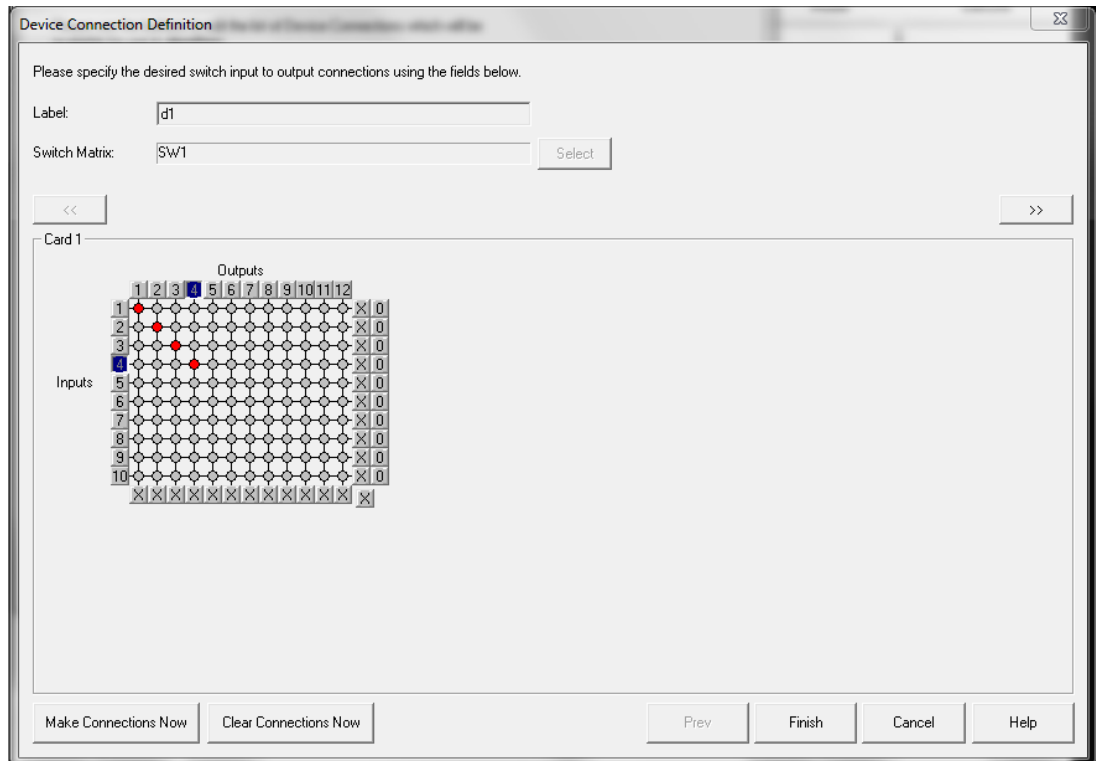

4. Select the switch that will be used.

Note: If only one switch card is configured in the ICV System Configuration, then the **Select** button will be inactive.

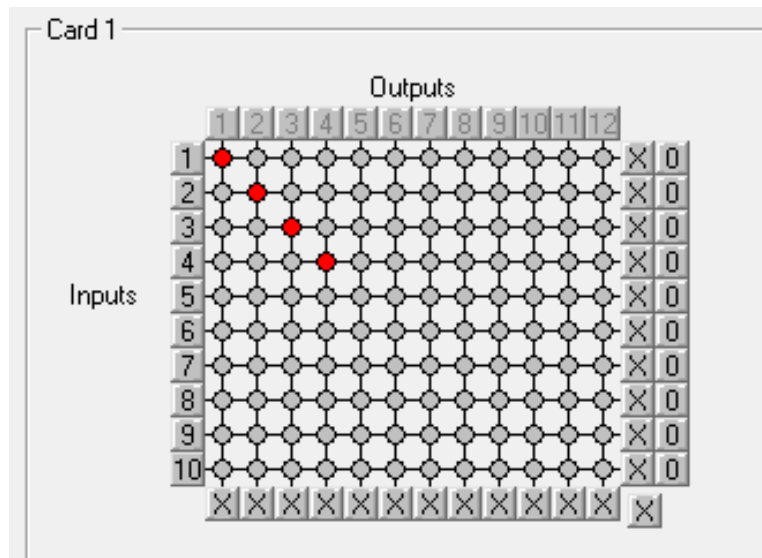

5. Click the “o” at the junction of the input and output that corresponds to the desired switch path connection. Alternatively, click the label of the input and then the label of the output to mark their intersection.

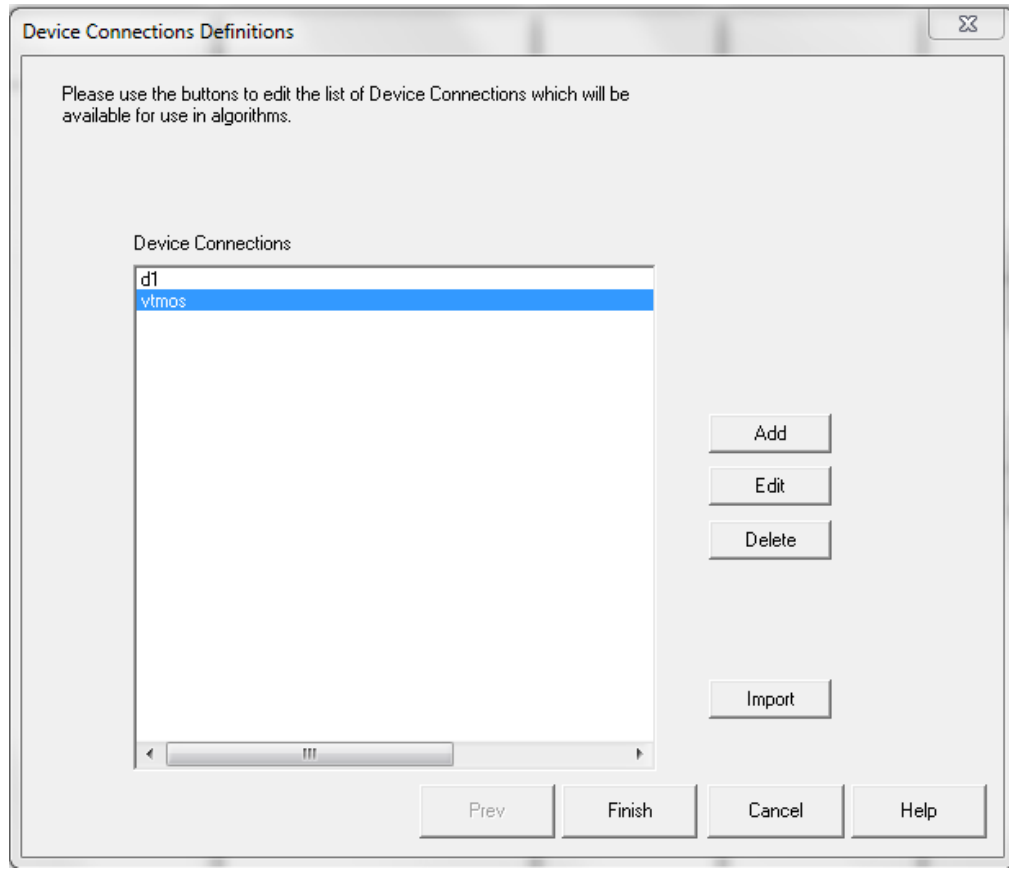

6. Click the **Finish** button to return to the list of defined device connections. Clicking **Finish** saves the new switch setting definition.

7. Click **Finish** to exit the Device Connections Editor.

Testing the Connections

After creating a device connection, the Device Connection Editor provides a capability to manually execute the device connection. This feature has two primary uses:

- To test the switch path (with a DVM).
- To allow the execution of an algorithm for debug testing.

The **Make Connections Now** button sends the commands to the switch matrix for closing the selected cross points. The connection pattern remains on the switch card until either the power to the switch matrix is switched off or a different set of cross points is sent.

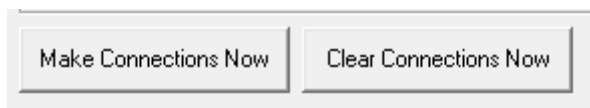

To verify the connections:

1. Click the **Make Connections Now** button.

To clear the connections:

1. Click the **Clear Connections Now** button.

Saving the Switch Connection File

Unlike previous versions of the Metrics Switch application, Metrics ICV software automatically saves the switch pattern. Thus there is no need to manually save the device connection.

Chapter 4- Creating Measurements

Introduction

The next step to creating a test plan is to create the individual measurements. These measurements are created within the Metrics ICS software or Visual Basic Script.

This chapter specifically deals with using Metrics ICS to create the measurements. The Visual Basic Script editor is described within the IDE - (Integrated Development Environment) Reference Manual.

Topics Covered

- What is Metrics ICS Software?
- Configuring ICS
- Creating a Sweep Measurement
- Creating a Spot Measurement
- Saving the Measurement

This chapter introduces the Metrics ICS (Interactive Characterization Software) measurement engine and demonstrates how to create measurements with it. Special demonstration drivers have been created to allow the development to be independent of the instrument. For details about the instrument drivers provided with Metrics ICS, please refer to the Metrics ICS documentation. The steps to creating a test method will be covered.

Note: This is not complete coverage of the Metrics ICS test engine. For a more thorough discussion of ICS please refer to the ICS Technical Reference Manual.

What is Metrics ICS?

Metrics ICS (Interactive Characterization Software) is a software application that is used by Metrics ICV as a measurement engine. Metrics ICS provides a windows based environment for creating measurement using a point and click methodology.

For measurement development the Metrics ICS environment can be used stand-alone.

Metrics ICS is:

- Measurement Engine
- Windows based
- Point, Click, and Measure
- Non-automated Applications

Start Metrics ICS by selecting **Development >> Algorithm Editors >> ICS** menu item or click on the **ICS** button.

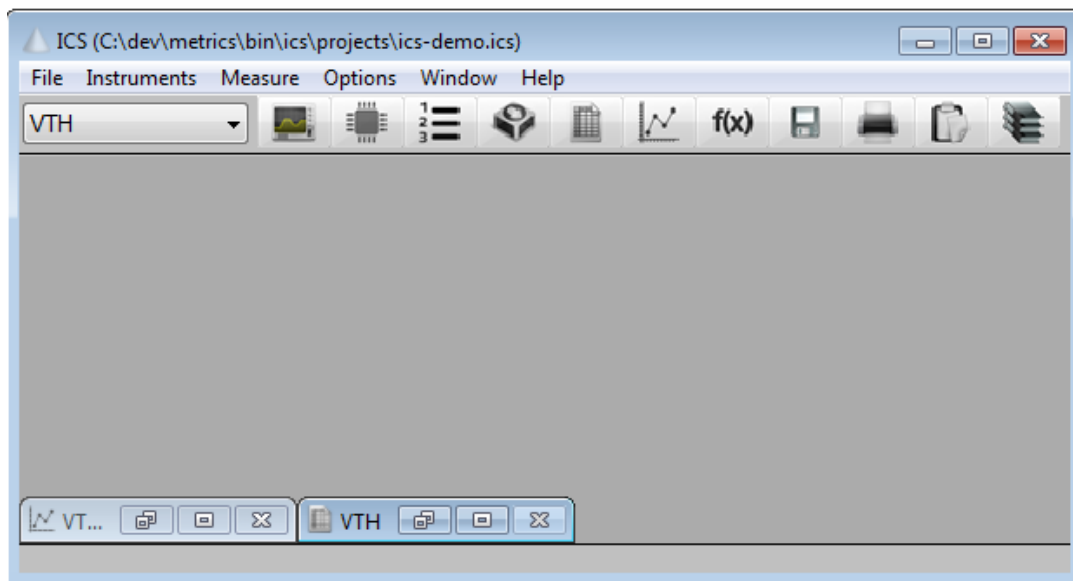

Configuring Metrics ICS

Before creating a measurement, Metrics ICS must know what instrument is being used. This is accomplished by configuring the instrument in ICS. Once an instrument has been configured, ICS will remember this configuration. The only time ICS must be reconfigured is when the instrument is changed or the ICS40.INI file is erased.



1. Click the "Select Instrument" button.
2. Highlight the instrument to be added and click the "Connect" button.

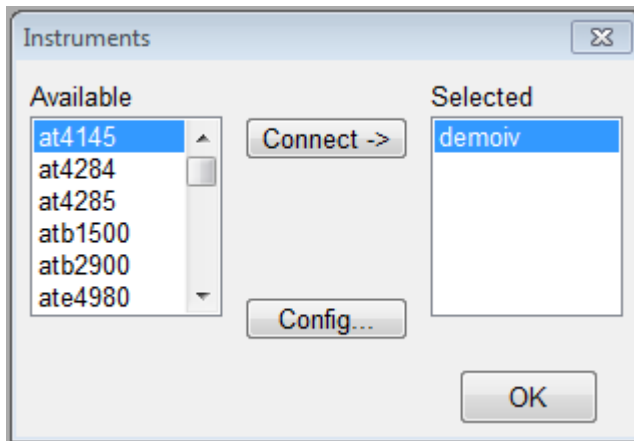

After the Instrument driver is selected, it must be configured.

1. Highlight the instrument to be configured and click the **Config** button.
2. Enter the GPIB address.

Polling an Instrument

To confirm that the instrument and Metrics ICS are communicating properly, poll the instrument.

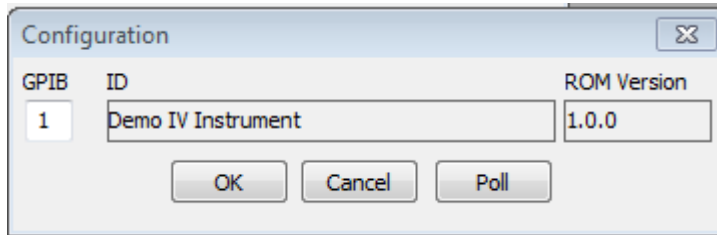

1. Click the **Poll** button.
2. Click the **OK** button to close the Configuration window.
3. Click **OK** button to close the Instruments window.

Create a Sweep Measurement

The following example demonstrates how to create a sweep measurement using ICS. This example uses the demonstration driver within ICS.

To Create a Sweep:

1. Open the setup editor.

The Setup Editor is the dialog in Metrics ICS where the measurement is configured. It can be opened by clicking the Setup Editor button.

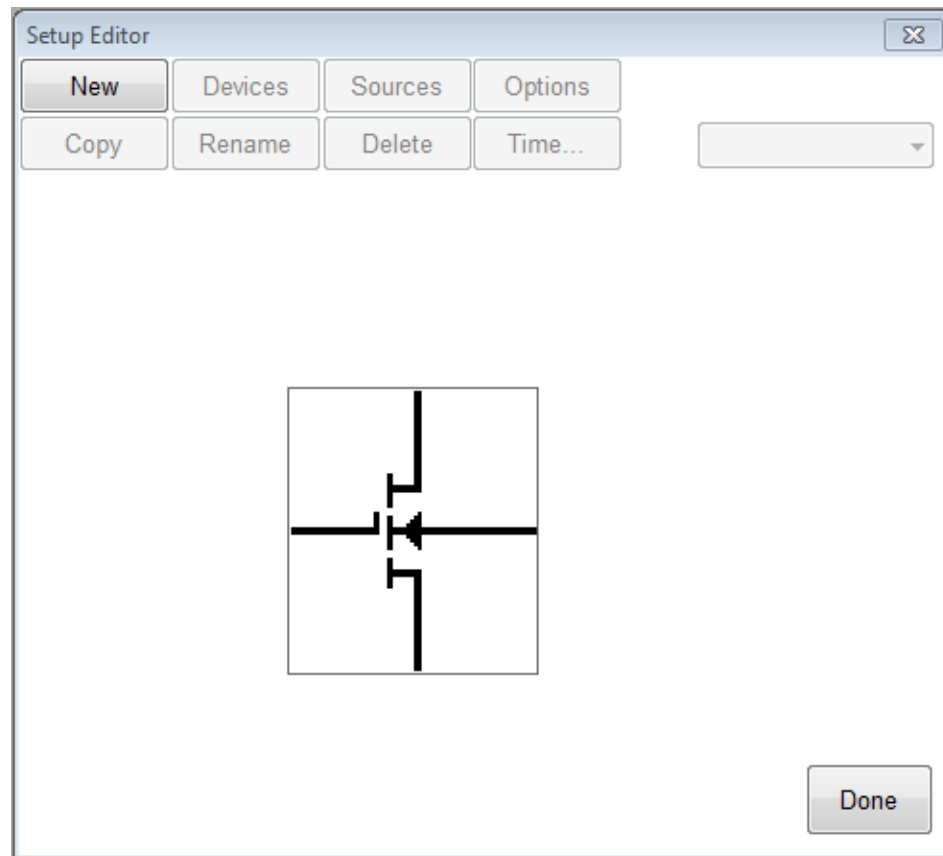

2. Click "New" to create a new setup

3. Name the Measurement Setup.

Each measurement must have a unique name. Before the measurement can be created, it must be given a name. To name the measurement:

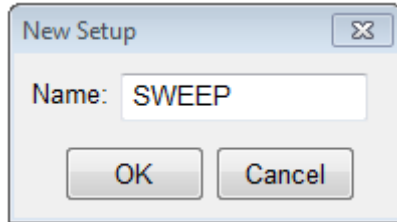

- a. Click the **OK** button after entering the name.

4. Select Source Units.

The source units correspond to the outputs of the instrument you are using. Metrics ICS provides a graphical way to document the connections for later reference. To add a source unit:

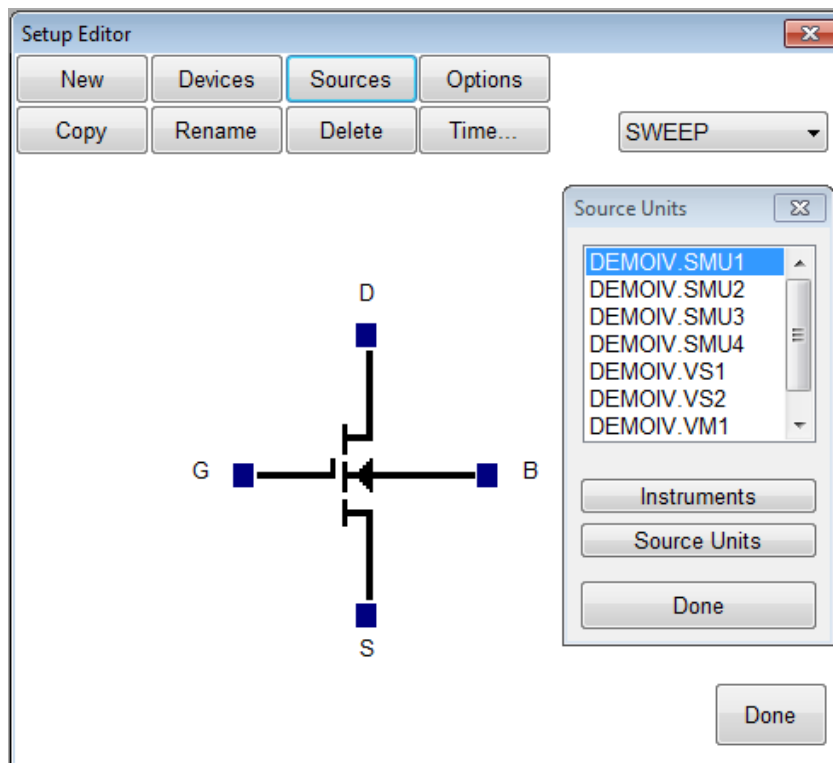

- a. Click on the **Sources** button to open the Source Units window.
- b. Highlight the specific unit.
- c. Click the blue box beside the device lead in the Setup Editor.

To remove a source unit:

- a. Highlight the attached unit.
- b. Click the blue box beside the device lead in the Setup Editor.
- c. Click the **Yes** button when asked if "Do you really want to remove the source".

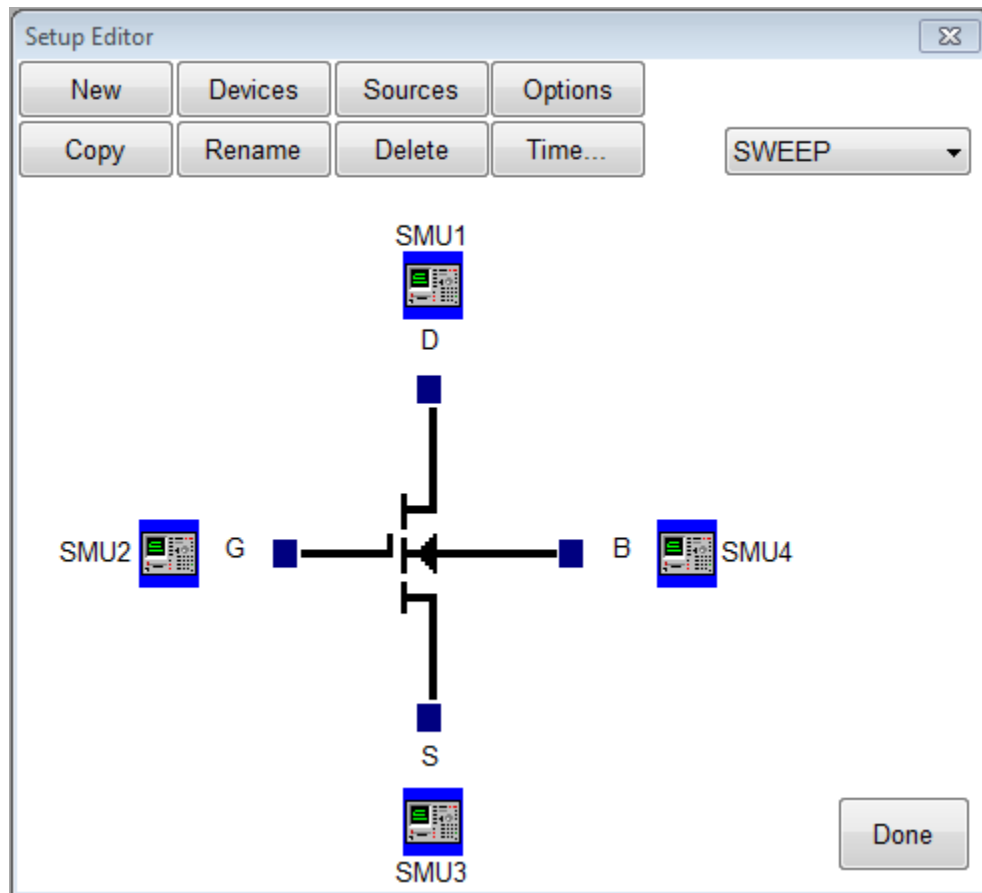

Note: The graphic is merely a representation of the device. The software does not expect behaviors from the data. Thus, the pin-out does not have to exactly match, rather it is only for reference.

5. Configure Source Units.

In this example we are creating a sweep source, so we must configure the source unit properly. To setup a sweep source:

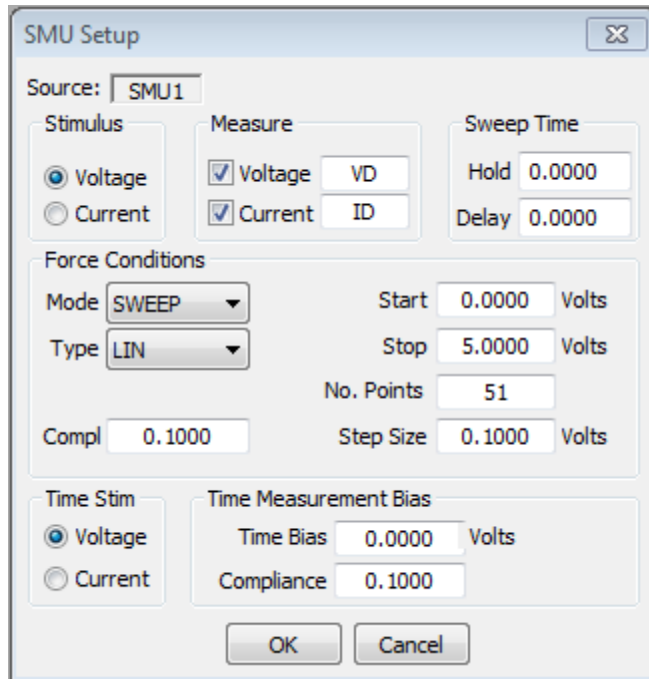

- Select the stimulus type.
- Select the values to be measured (see note below).
- Click the blue box beside the device lead in the Setup Editor.
- Select the sweep timing (see note below).
- Select the Source Mode. In this case we want it to be Sweep.

Setup the sweep parameters.

Note: Most SMU's can only measure the signal that is not being sourced. Therefore in this case we have selected the Stimulus to be Voltage resulting in the Current being measured. The values returned for Voltage in this case would be the calculated voltage steps. The opposite is true when the Stimulus mode is set to Current. The Sweep Time parameters are to control the rate of the sweep. Please note that these inputs vary for different instruments.

Create a Spot Measurement

In this example we will create a spot (or single point) measurement. Most of the steps are the same or similar to creating a sweep measurement. The first step is to open the setup editor. The setup editor can be opened by clicking the Setup Editor button.

To Create a Spot Measurement:

1. Open the setup editor.

The Setup Editor is the place in ICS where the measurement is configured. It can be opened by clicking the Setup Editor button.

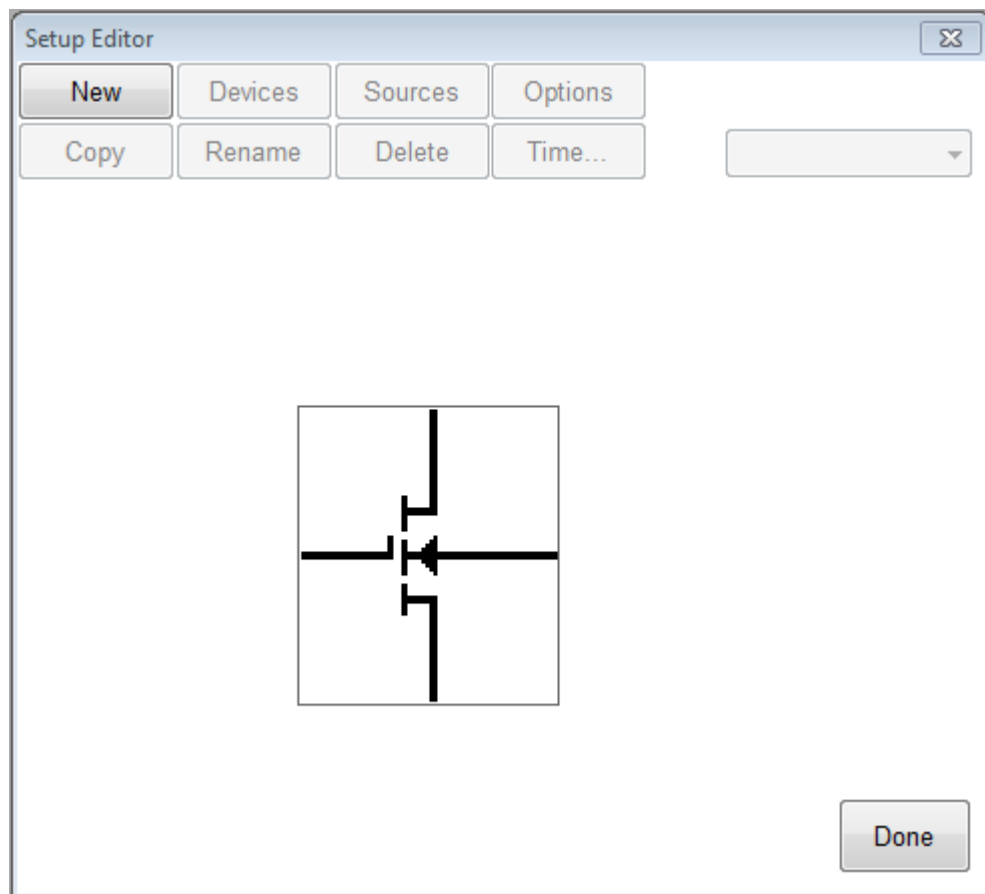

2. Name the Measurement Setup.

Each measurement must have a unique name. Before the measurement can be created, it must be given a name. To name the measurement:

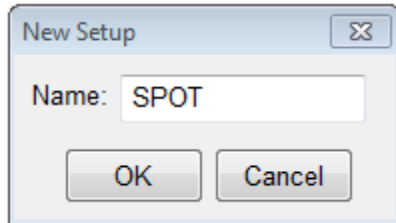

- Click the **New** button and type in a name.
- Click the **OK** button after entering the name.
- Select Source Units.

The source units correspond to the outputs of the instrument you are using. Metrics ICS provides a graphical way to document the connections for later reference. To add a source unit:

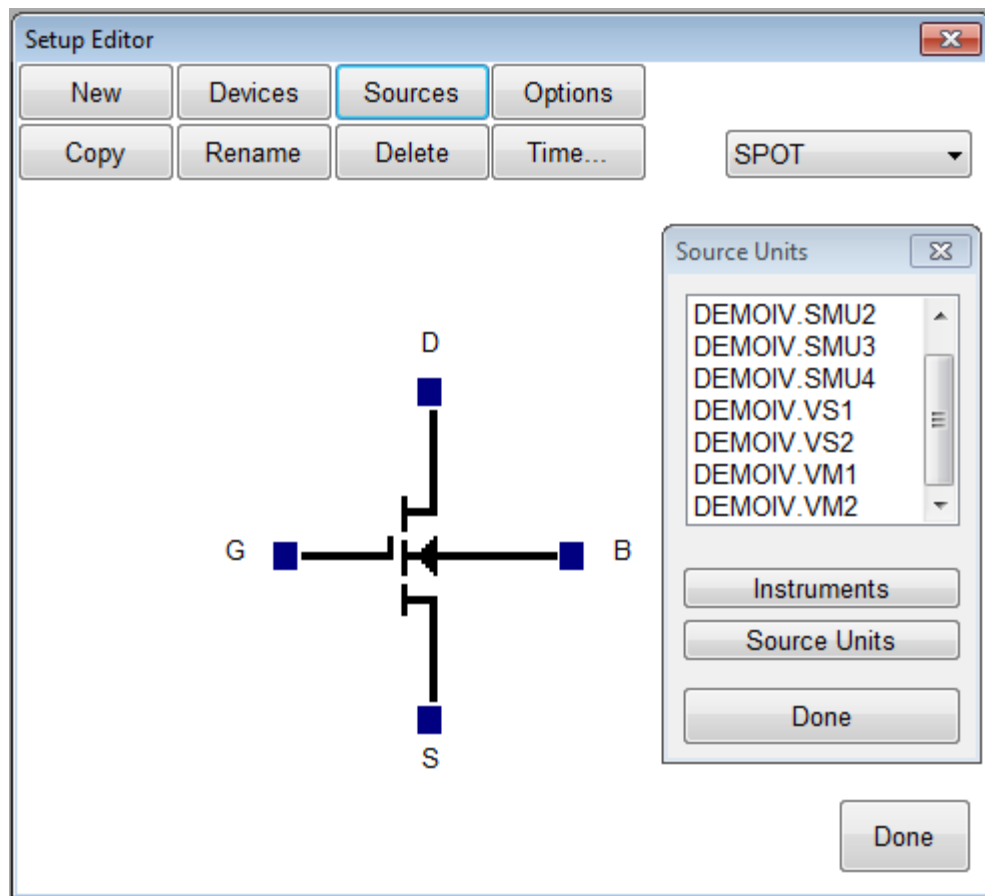

- Click on the **Sources** button to open the Source Units window.

- b. Highlight the specific unit.
- c. Click the blue box beside the device lead in the Setup Editor.

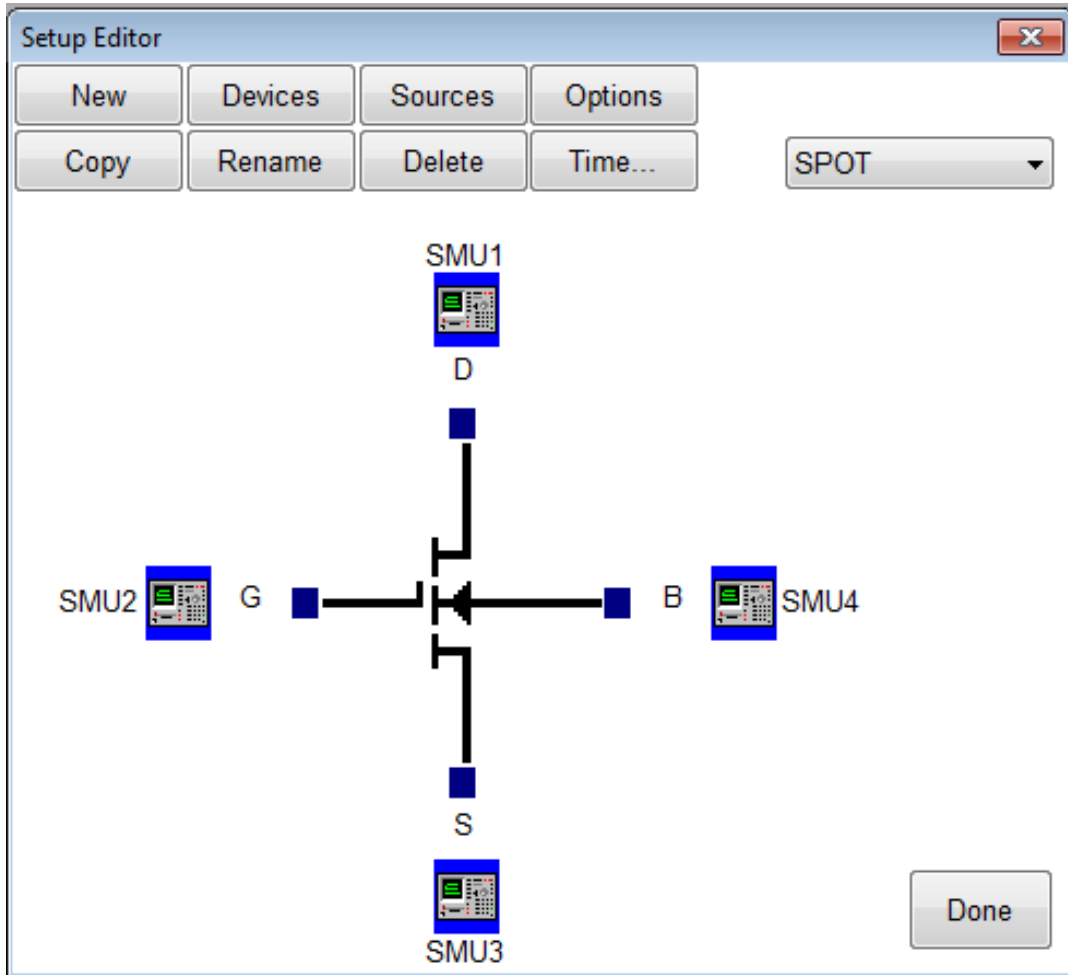

To remove a source unit:

- a. Highlight the specific unit.
- b. Click the blue box beside the device lead in the Setup Editor.
- c. Click the **Yes** button.

Note: The graphic is merely a representation of the device. The software does not expect behaviors from the data. Thus, the pin-out does not have to exactly match, rather it is only for reference.

3. Configure Source Units.

In this example we are creating a spot source, so we must configure the source unit properly. To setup a spot source:

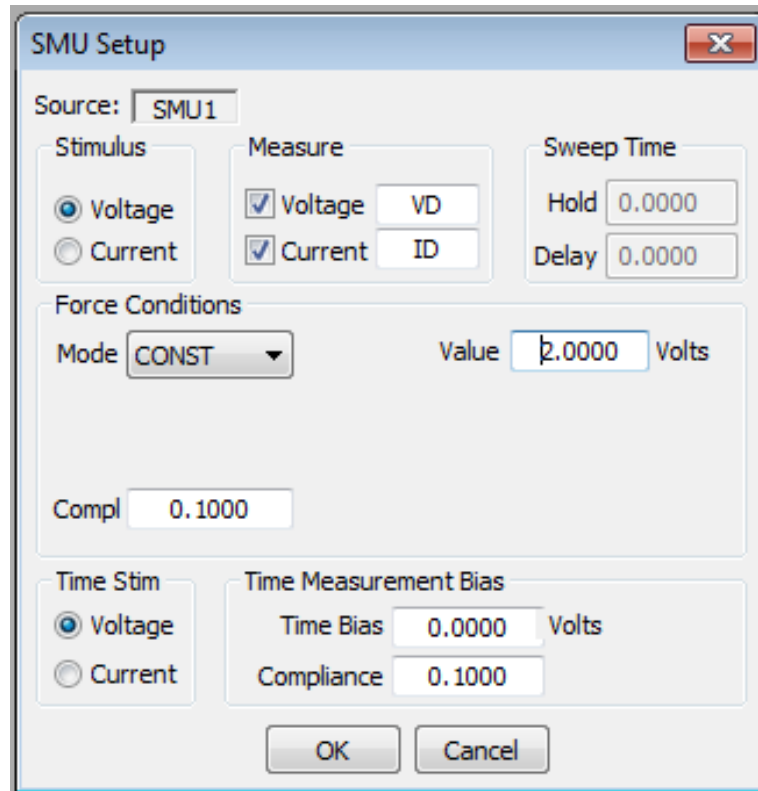

- Select the stimulus type.
- Select the values to be measured (see note below).
- Select the Source Mode. In this case we want it to be **Const**.
- Setup the source bias.

Note: Most SMU's can only measure the signal that is not being sourced. Therefore in this case we have selected the stimulus to be Voltage resulting in the Current being measured. The values returned for Voltage in this case would be the calculated voltage steps. The opposite is true when the Stimulus mode is set to Current. Please note that these inputs vary for different instruments.

Executing the Measurement

The measurement mode is **Standard** by default. Thus all of the previous measurement types (sweep and single point) did not need this value changed.

To access the Measurement Remote control click on the **Measure** button on the ICS toolbar.



To Execute a Measurement:

1. Make sure the measurement name is displayed in this box.
2. Use the pull down menu to select the **Standard** mode.
3. Click the **Single** button to execute the measurement.

This toolbar contains buttons to begin the measurement as well as menus to select the measurement and mode.



At this point the software will communicate with the instrument and execute the measurement.

Data Return

Metrics ICS (Interactive Characterization Software) automatically returns the data from an executed measurement. The data is presented in a built-in spreadsheet. The spreadsheet is automatically created when a test setup is created. It will begin as a minimized window in the lower left corner of the ICS window. To view the data simply double-click the window that has the same name as the test setup.

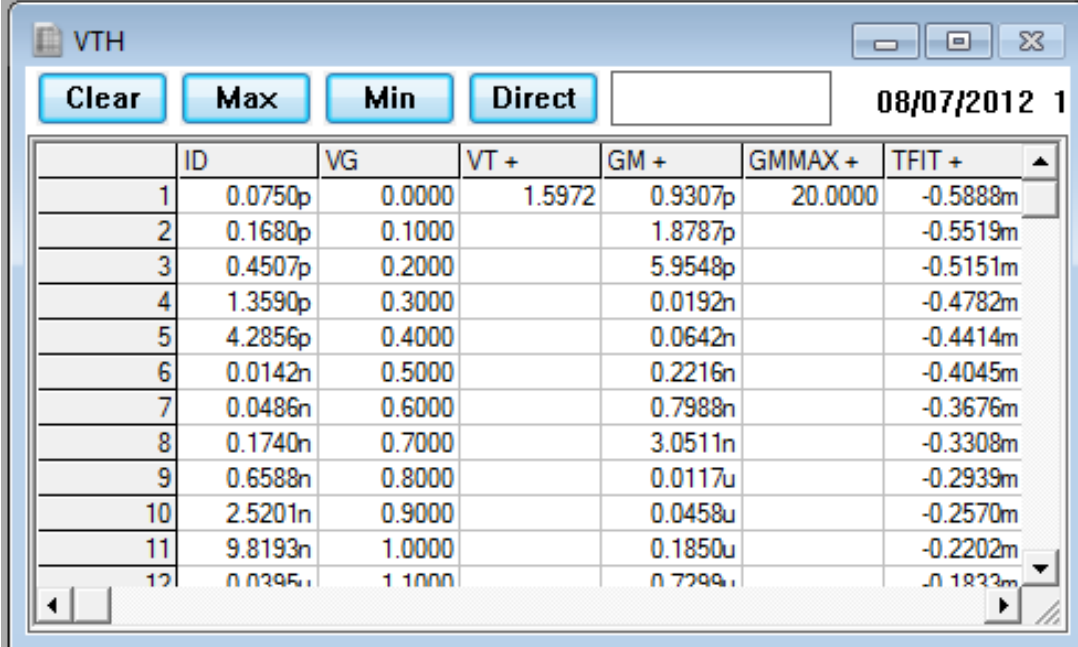

The screenshot shows a window titled "VTH" with a spreadsheet interface. At the top, there are buttons for "Clear", "Max", "Min", and "Direct", followed by a date "08/07/2012 1". The spreadsheet has six columns: ID, VG, VT +, GM +, GMMAX +, and TFIT +. The data is as follows:

ID	VG	VT +	GM +	GMMAX +	TFIT +	
1	0.0750p	0.0000	1.5972	0.9307p	20.0000	-0.5888m
2	0.1680p	0.1000		1.8787p		-0.5519m
3	0.4507p	0.2000		5.9548p		-0.5151m
4	1.3590p	0.3000		0.0192n		-0.4782m
5	4.2856p	0.4000		0.0642n		-0.4414m
6	0.0142n	0.5000		0.2216n		-0.4045m
7	0.0486n	0.6000		0.7988n		-0.3676m
8	0.1740n	0.7000		3.0511n		-0.3308m
9	0.6588n	0.8000		0.0117u		-0.2939m
10	2.5201n	0.9000		0.0458u		-0.2570m
11	9.8193n	1.0000		0.1850u		-0.2202m
12	0.0295u	1.1000		0.7299u		-0.1823m

Saving the Measurement

The last step to creating measurements is to save them. A measurement or collection of measurements is saved in a Project File. To save a project file select **Save As ICV Algorithm** from the File Menu of ICS, select a directory, enter a name, and click the **OK**.



Note: Project Files can be saved in any directory. However if you plan to use the test with ICS it **MUST BE SAVED IN THE METRICS\ALGS DIRECTORY** or a sub-directory within the Metrics\algs directory.

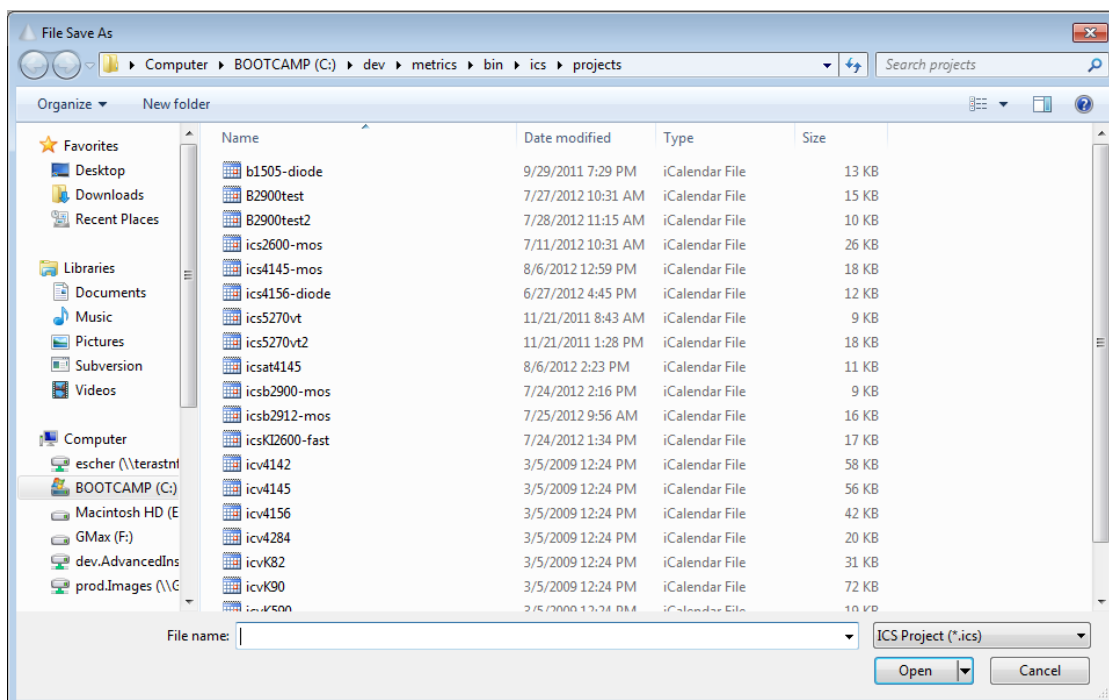

Chapter 5- Creating a Module Test

Introduction

The next step in creating a test plan is to build a module test script containing the ICS algorithms and device connections. The module test designates the order in which actions occur during testing of a specific module.

Topics Covered

- What is a Module?
- What a Module Test Does
- Creating a Module Script

What is a Module?

Metrics ICV uses the concept of a Module to define a level of scripting available in the design of tests. At some companies, the module is called a sub-die, quad, or TEG. Metrics ICV uses a definition which is based upon the function and equipment of the specific test system it is installed upon.

A module is all of the devices that the probe needles are able to touch at the same time (without moving the probe chuck, needles, or platen).

Below are two examples of modules. The picture on the left is the case where the probe station has a 2x6 probe card. The probe needles can touch the 12 pads at the same time without having to move the probe chuck. The picture on the right is the case where the probe station has 4 discrete positioners and only 4 device pads can be contacted at the same time without moving the chuck or positioner.

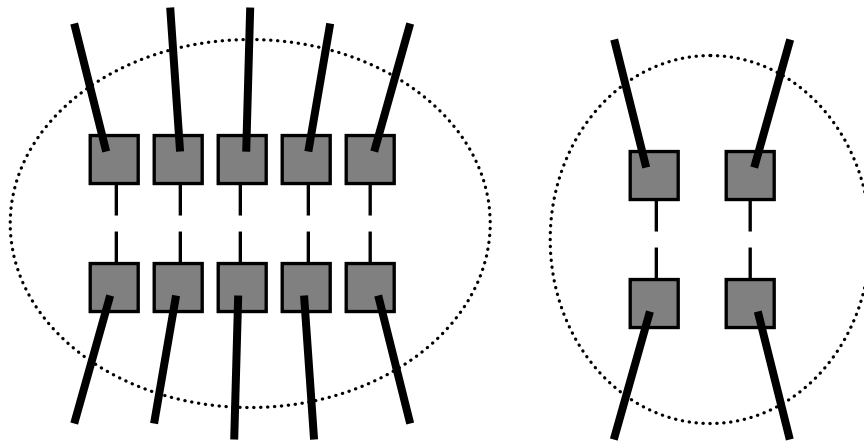

What a Module Test Does

A module test is a collection of the tests that are to be performed at a specific module location. If the probe system is using a probe card and switch matrix, then the module test would control both the setting of the switch matrix (device connection) and the running of test algorithms (ICS or VBScript) for any of the devices within the module.

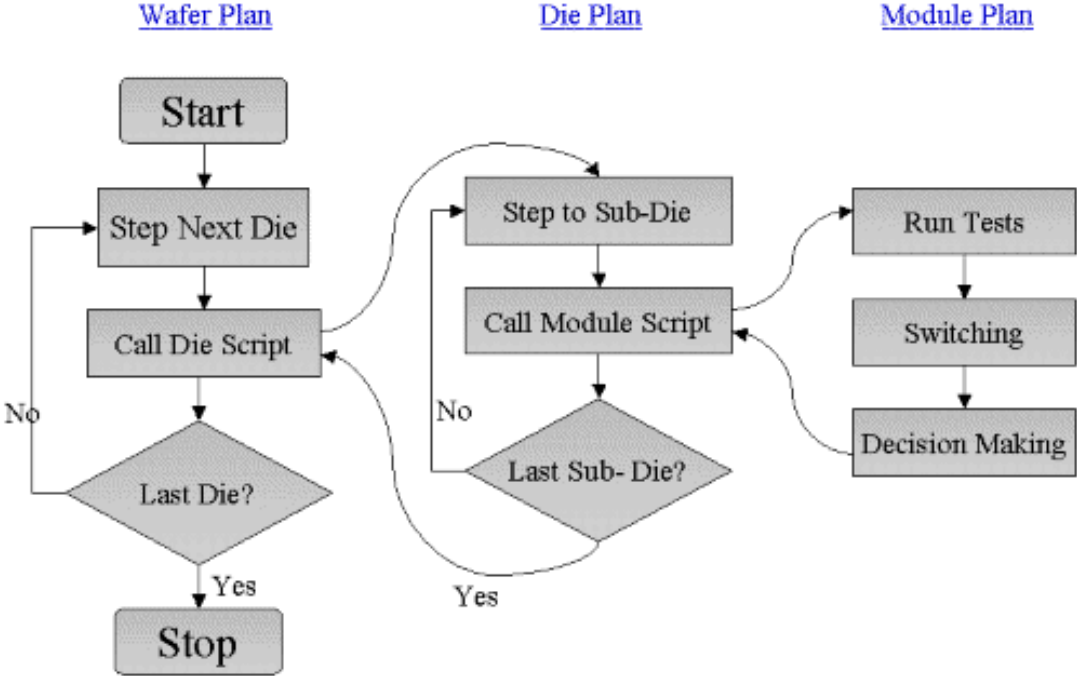

The module test is typically called by a die test script (see next chapter).

Creating a Module Test Script

Module Test Scripts specify and control all of the testing performed without moving the wafer chuck. Algorithms can be combined with device connections (Switching), If-Then structures, and Variables to create a testing solution.

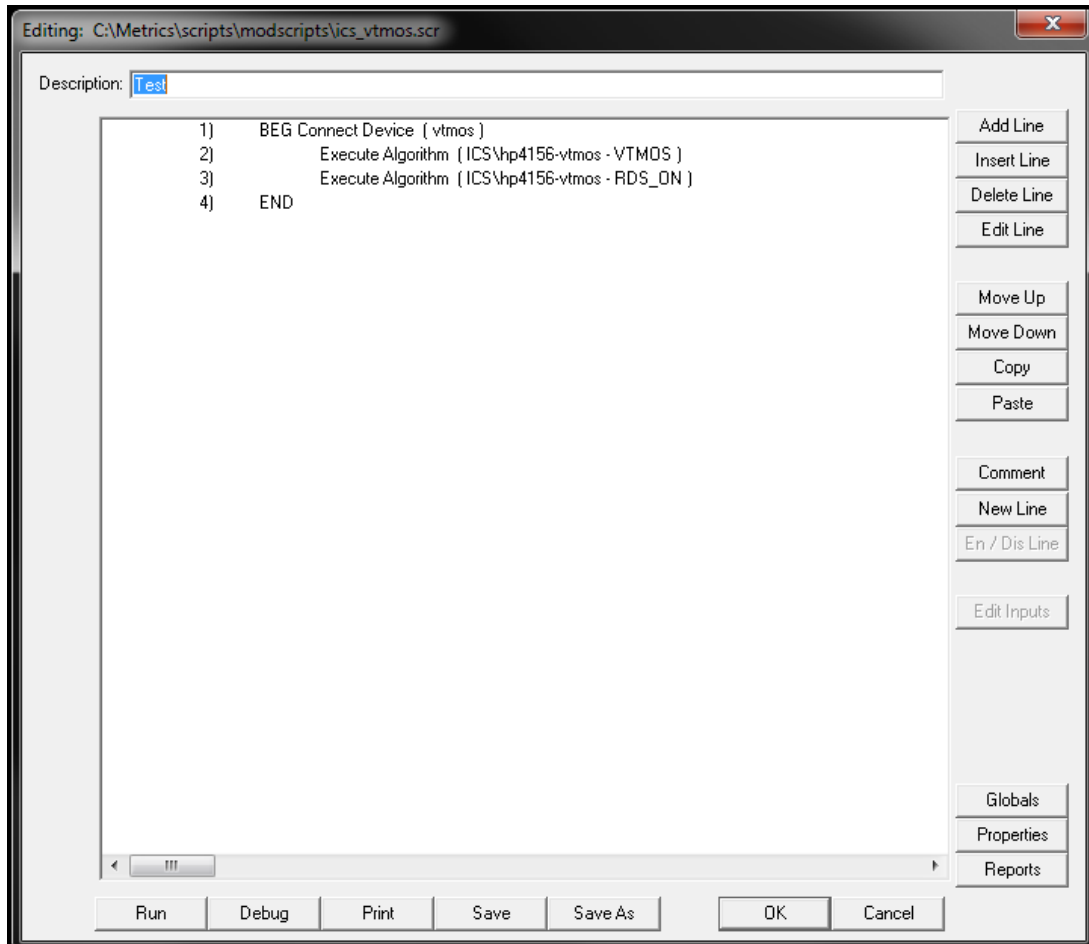

To create a Module Script:

1. Open the Module Test Editor by selecting **Development >>Module Test Editor** menu item or **Test Script** button in the Module area of the Metrics ICV navigation window.

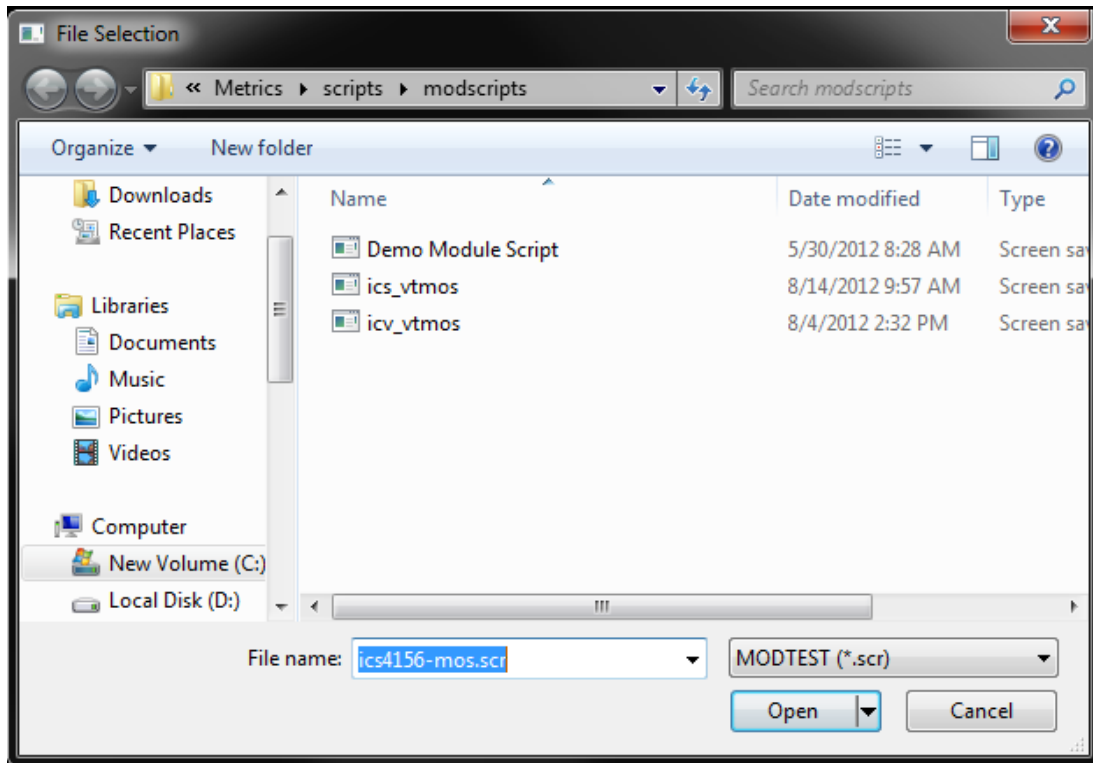

2. Select a name for the new script and click the **Open** button.

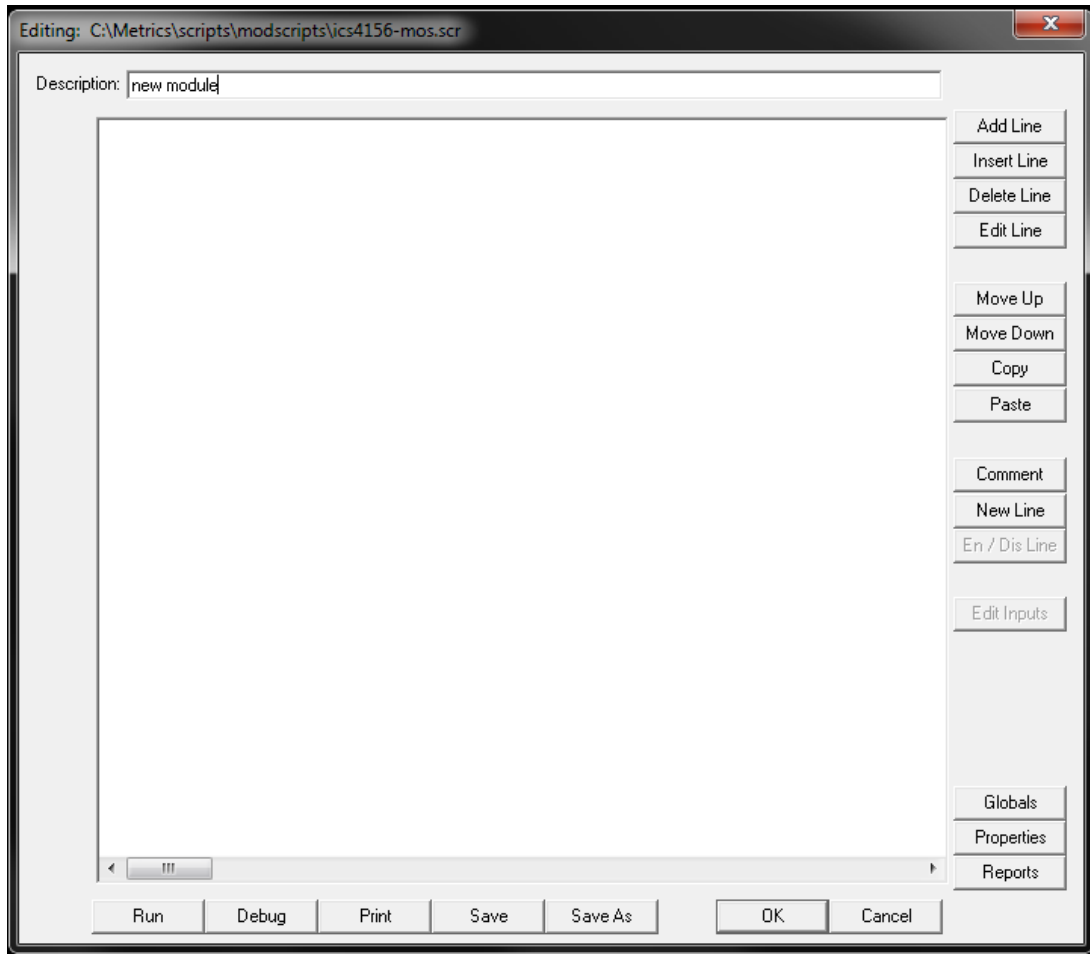

3. Enter a description in the Description Field.
4. Click the Add Line button. Select the **Connect Device** item and click the **Finish** button.

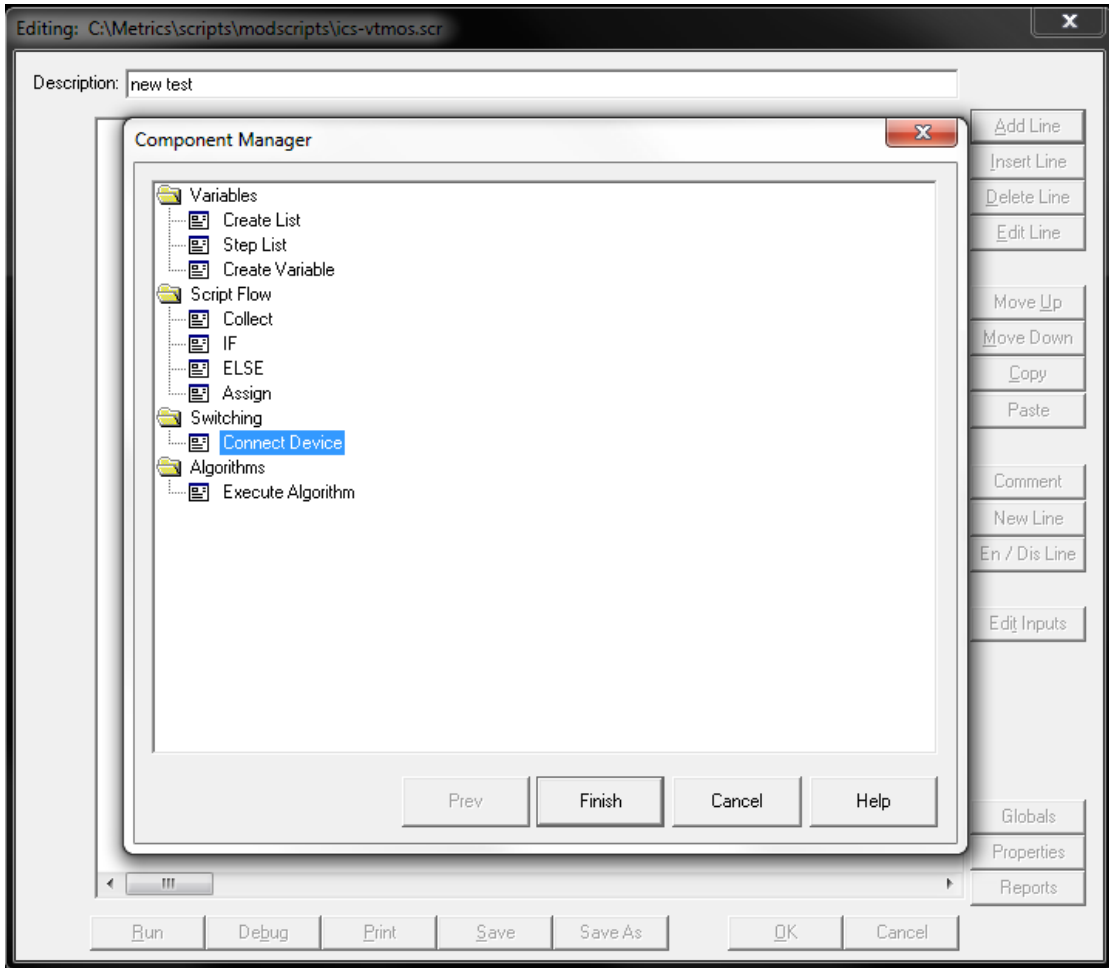

5. The Device Connect Sequence wizard will open. If you wish to run the same tests on a series of devices within a module, you can select all of those devices from this dialog and setup their order of execution.

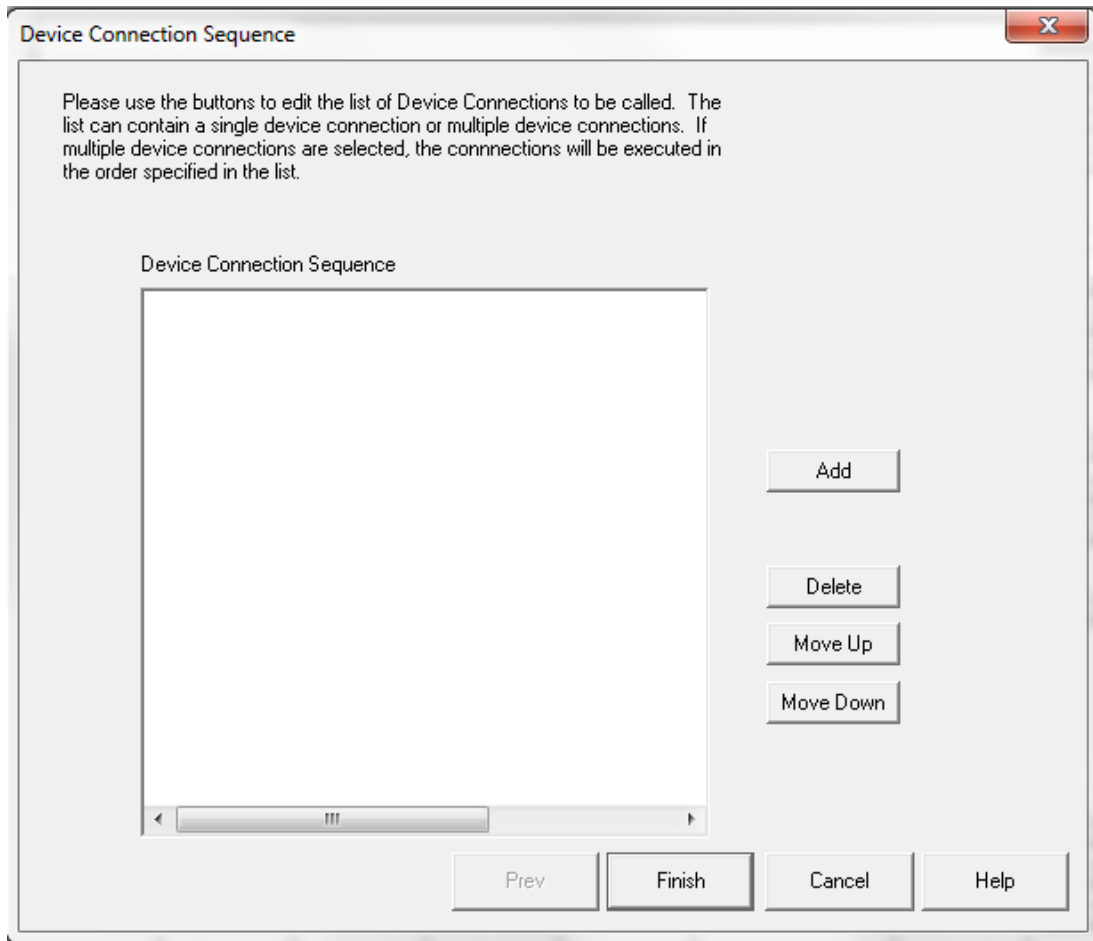

Click the **Add** button to begin creating a list of device connections.

6. Highlight all of the device connections you wish to add to the script item.

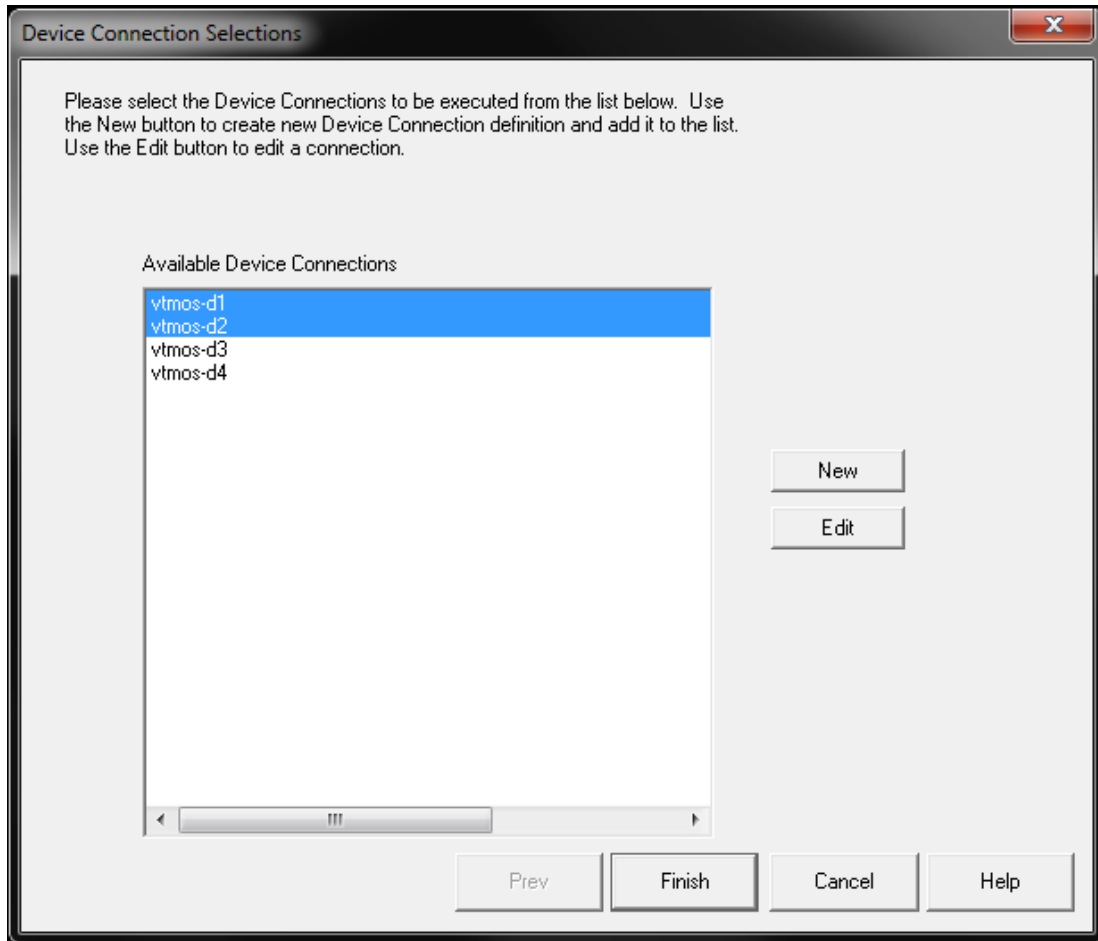

7. Click the **Finish** button to return to the Device Connection Sequence window.

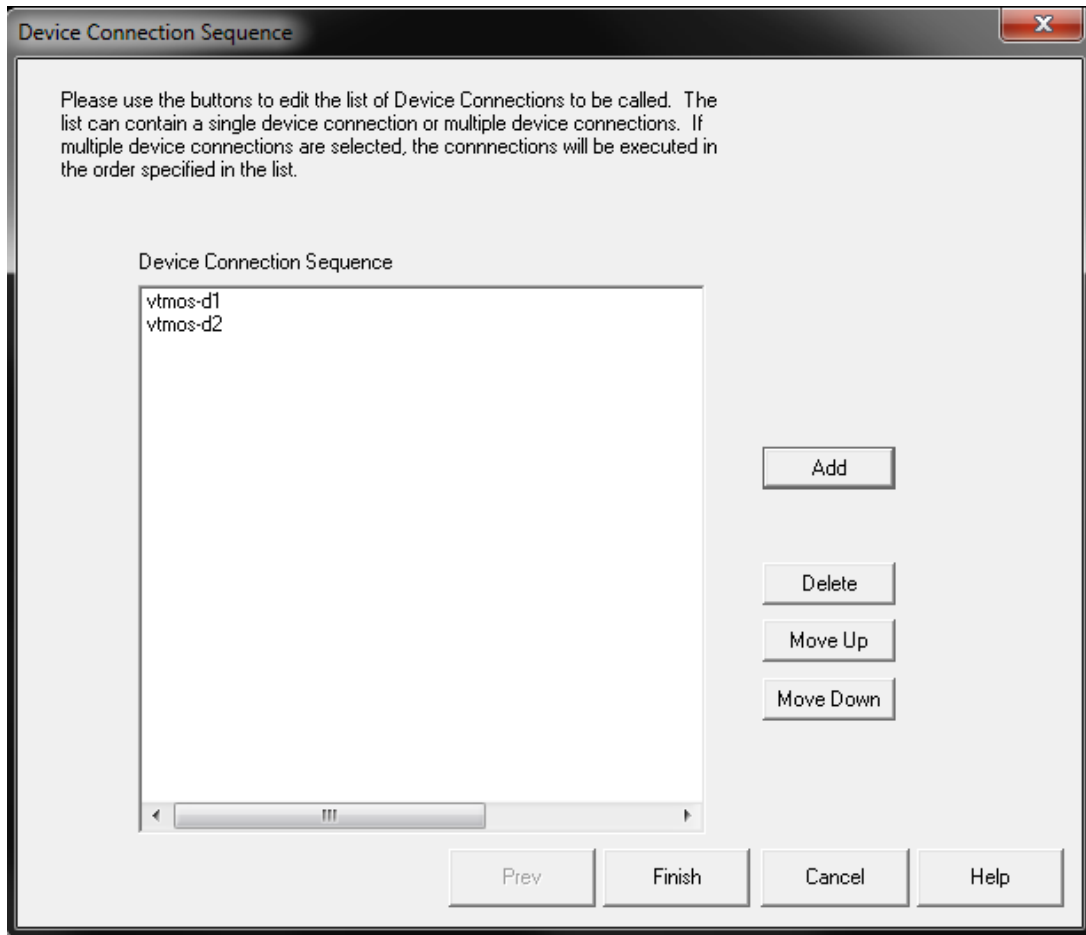

8. Highlight any of the connection names that you wish to change the order and use the **Move Up** and **Move Down** buttons to change the order of execution.

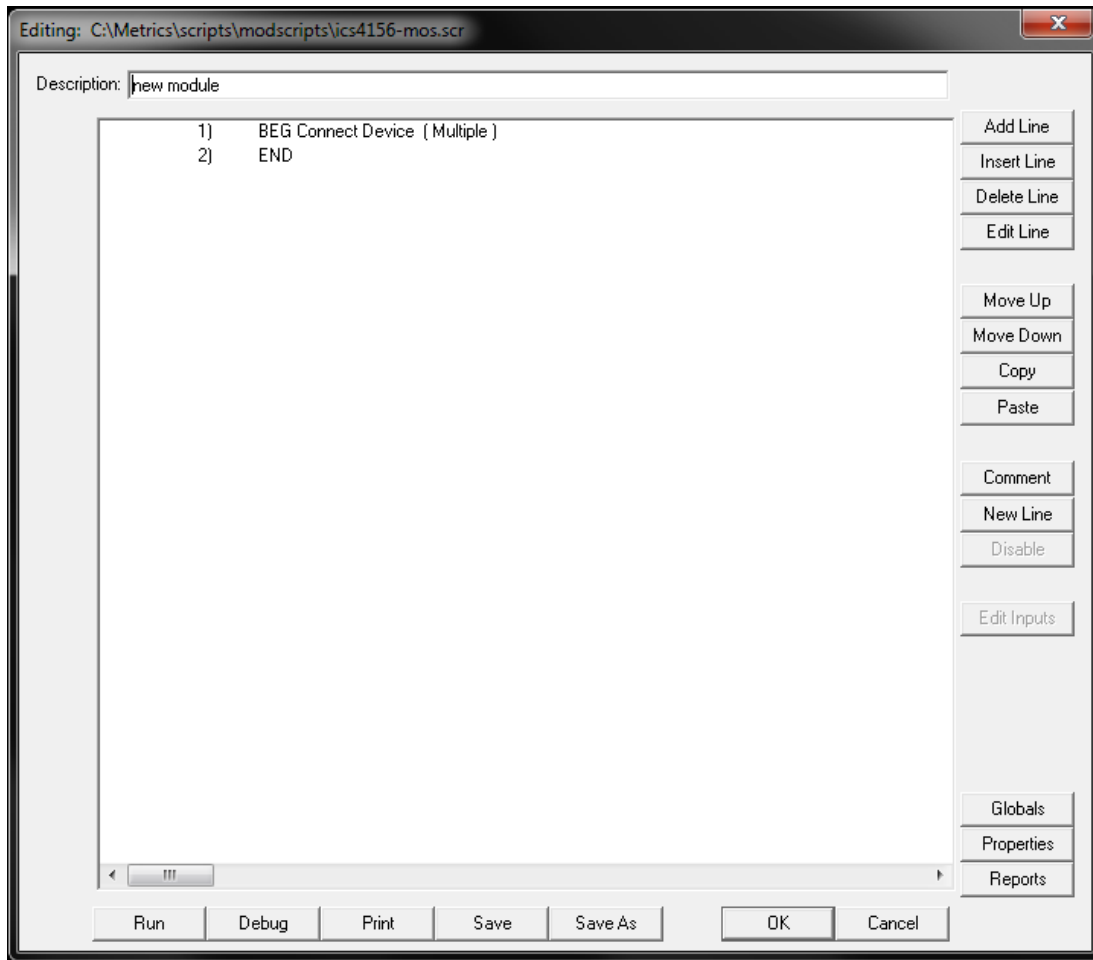

9. Click the **Finish** button to save the device connection sequence to the module test script.
10. Highlight the END statement and click the **Insert Line** button to begin adding an algorithm to the module test script.

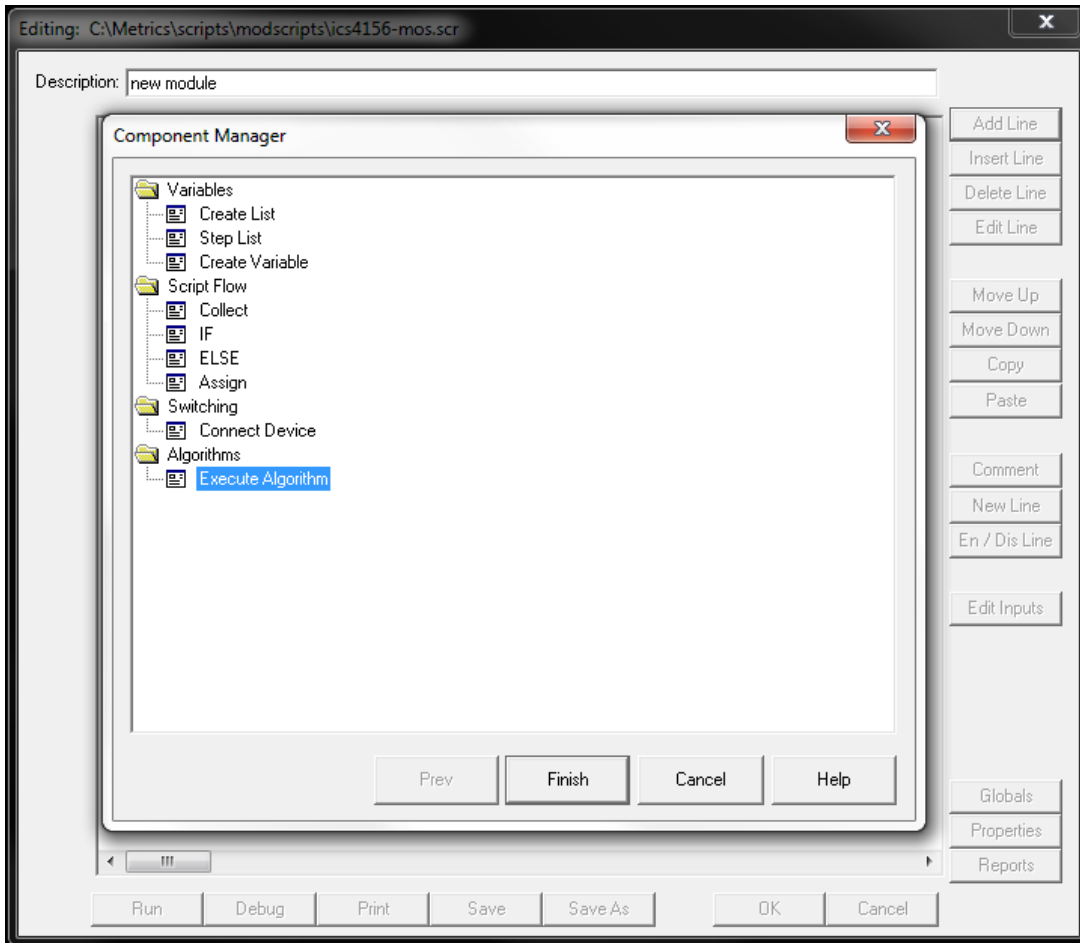

11. Select the **Execute Algorithm** function and click the **Finish** button.

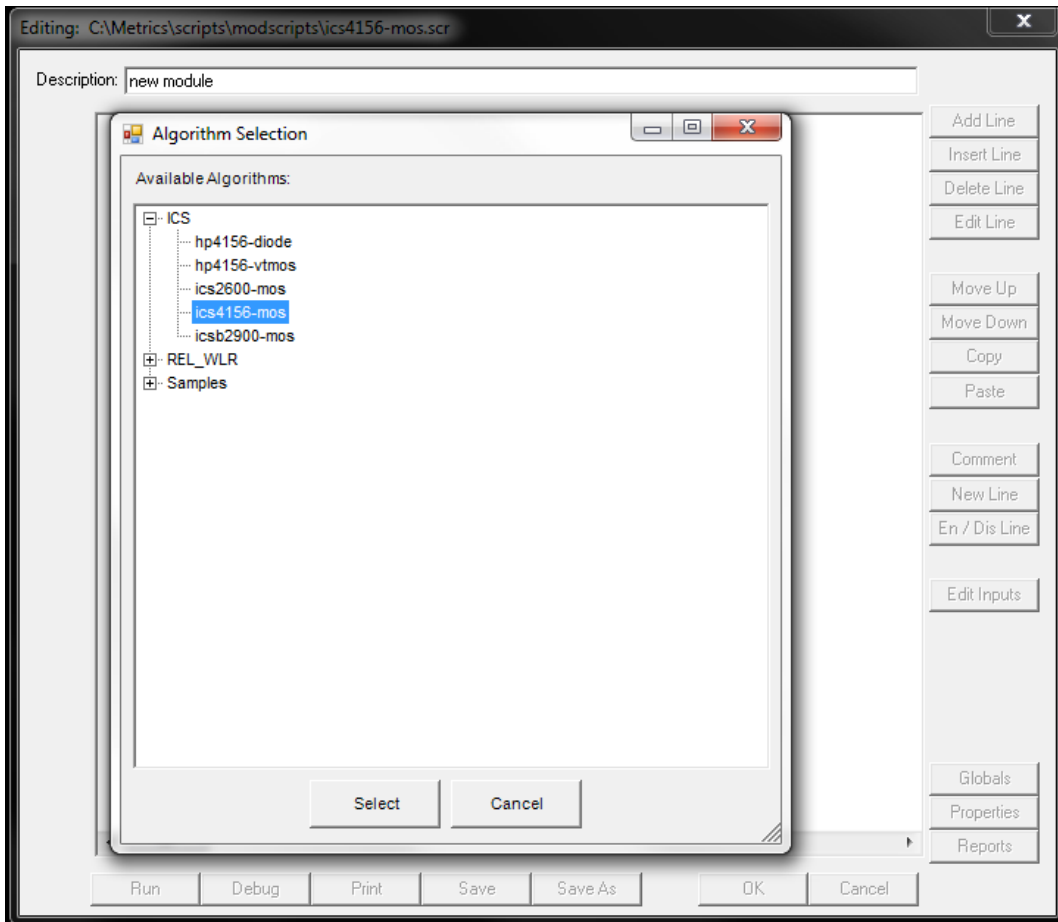

12. Choose the algorithm to run by highlighting the name of the algorithm and clicking the **Select** button.

Note: This window is displaying the contents of the Metrics\algs directory.

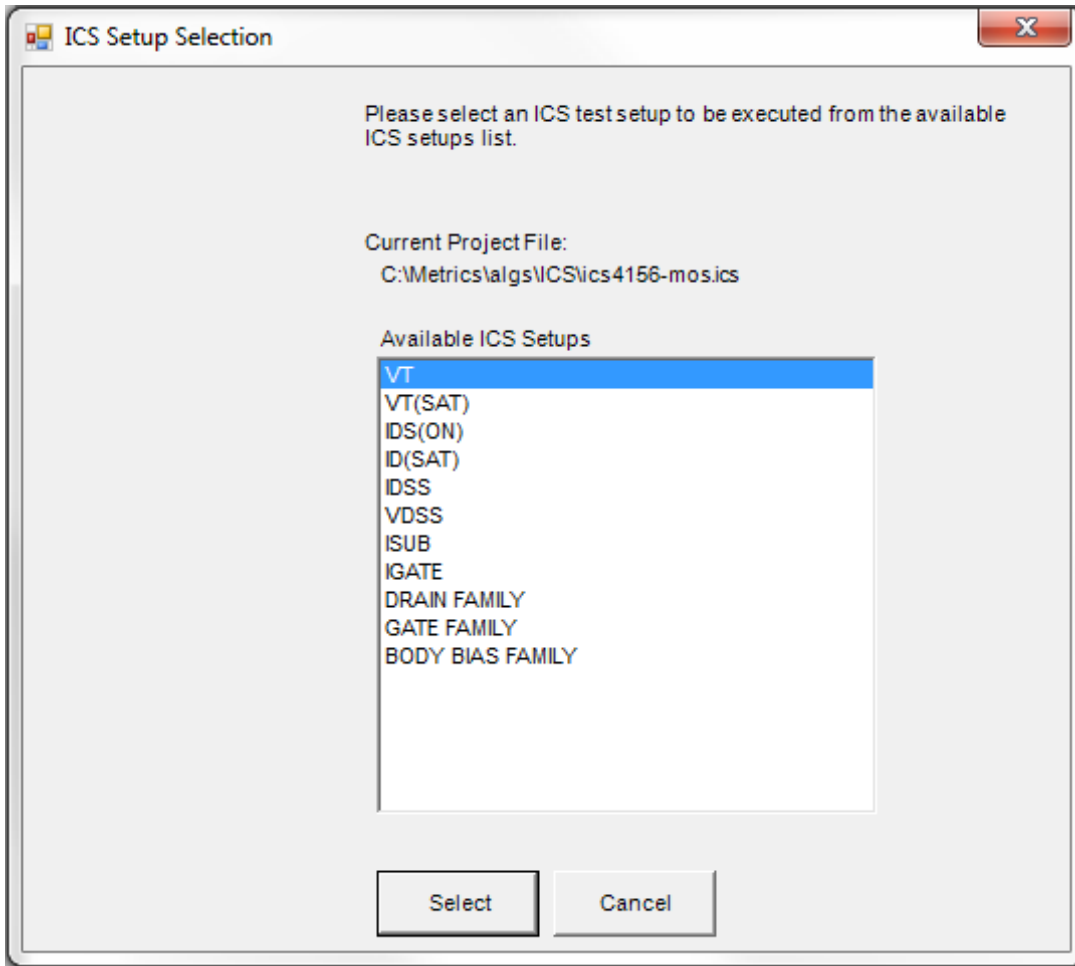

13. In the case of an ICS algorithm, Choose the test from the list and click the **Select** button.

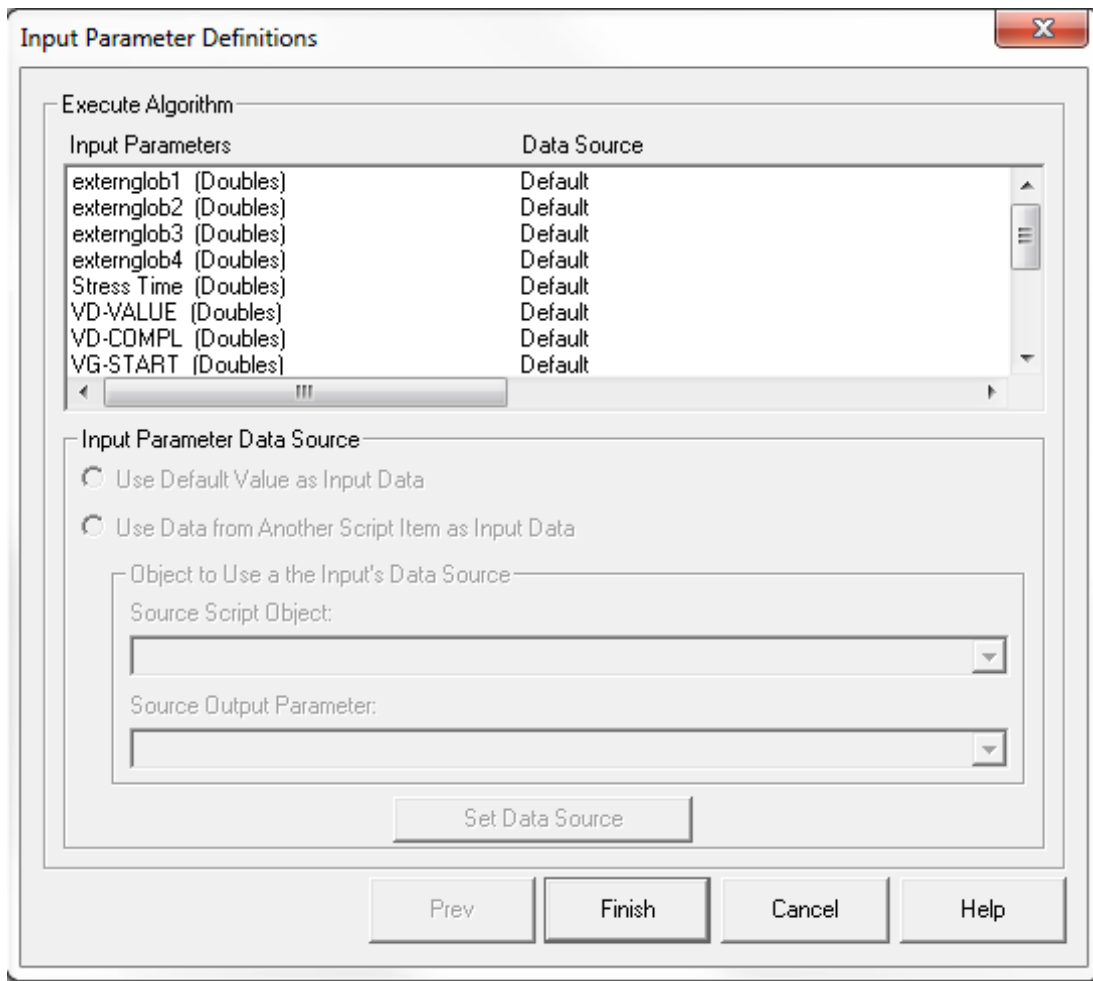

14. The next dialog allows the passing of inputs into the test. In this case we will skip this function and just click the **Finish** button. Please refer to the Metrics ICV Reference Guide for more information about mapping input parameters.

15. Save the module test script.

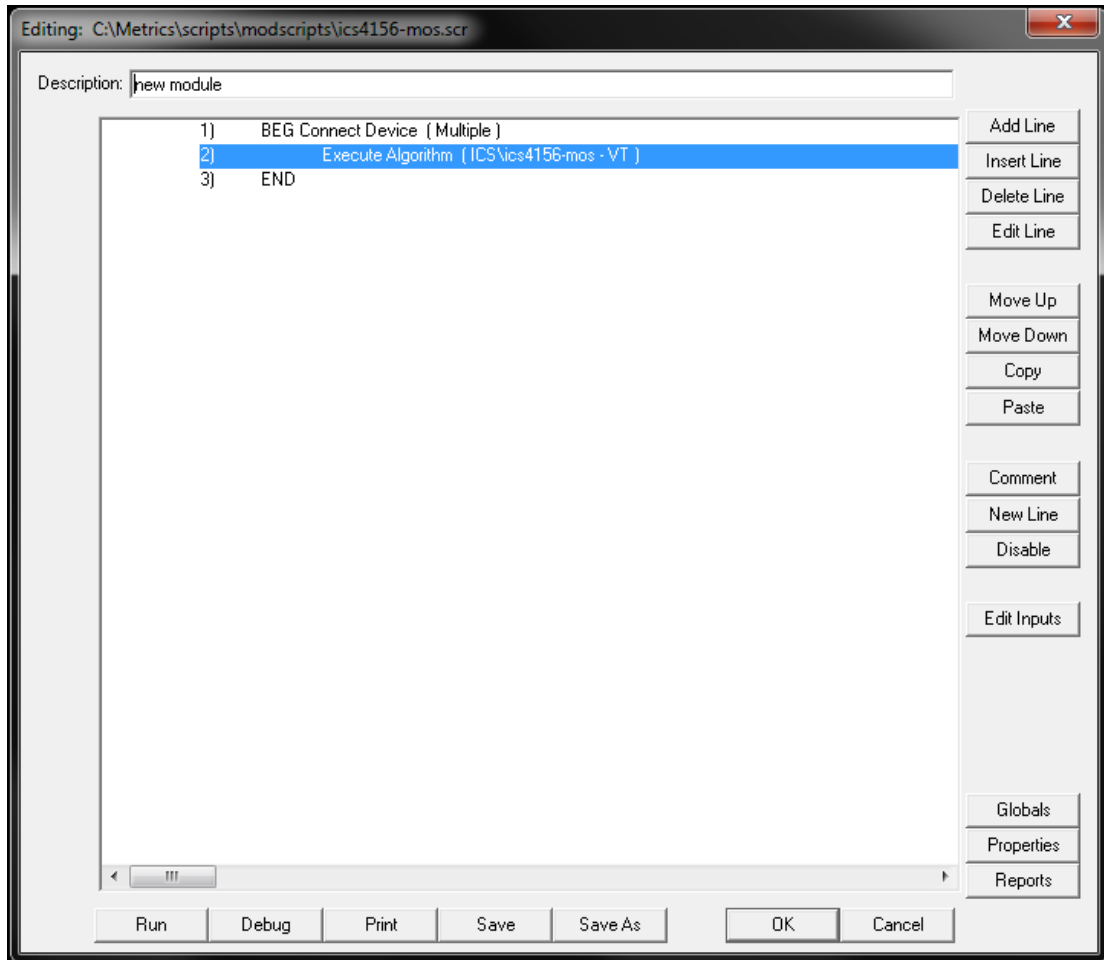

In the example above, all of the testing is performed from within a module script. This means that all of the devices being tested are part of the same structure and the wafer chuck is not being moved to reposition the wafer between tests.

Chapter 6- Creating a Module List

Introduction

The next step in creating a test plan is to build a module list. The module list is a collection of the locations of the modules within a die. All locations are made relative to a single reference position.

Note: If you are not planning to perform sub-die stepping you can skip this chapter and Chapter 7.

Topics Covered

- What is a module list?
- The coordinate system of the module list
- Creating a module list
- Importing a module list

What is a Module List?

A module list is a collection of the modules contained within a specific die reticle. The module list contains both the names and positions of the modules within the die. The module list is a convenient way to save this information and the list is independent of wafer maps. Thus if you have different stepping plans for the same wafer types, you can reuse the information stored in the list.

A module list contains all of the module locations entered by the operator. Not all of the locations must be used during test setup.

The Coordinate System of the Module List

The module list uses a standard X-, Y- coordinate system for the definition of distances between modules. When standing in front of the wafer probe station looking down upon the wafer chuck, positive X is to the right and positive Y is away from you (Up).

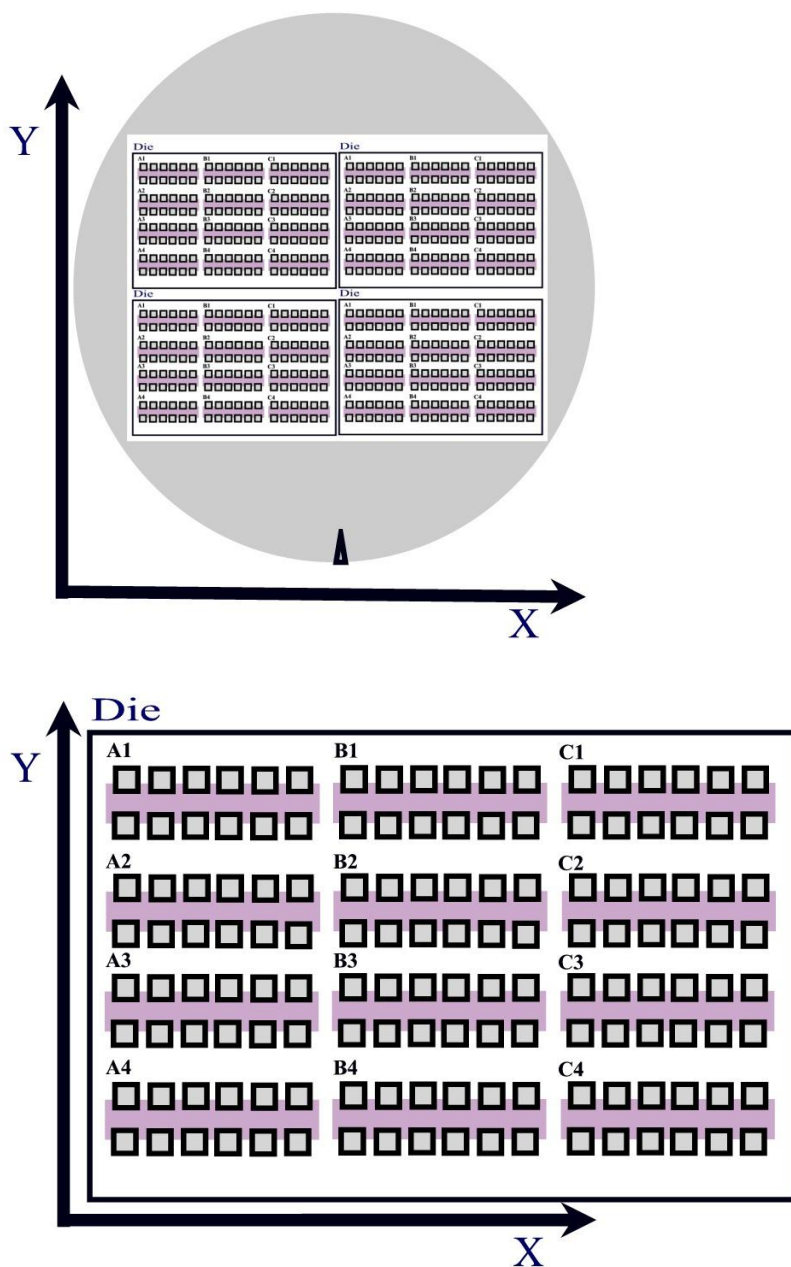

If the wafer is rotated 90 degrees, then the X and Y distances transpose. This must be taken into consideration if the wafer is loaded upon the chuck with the notch or flat rotated.

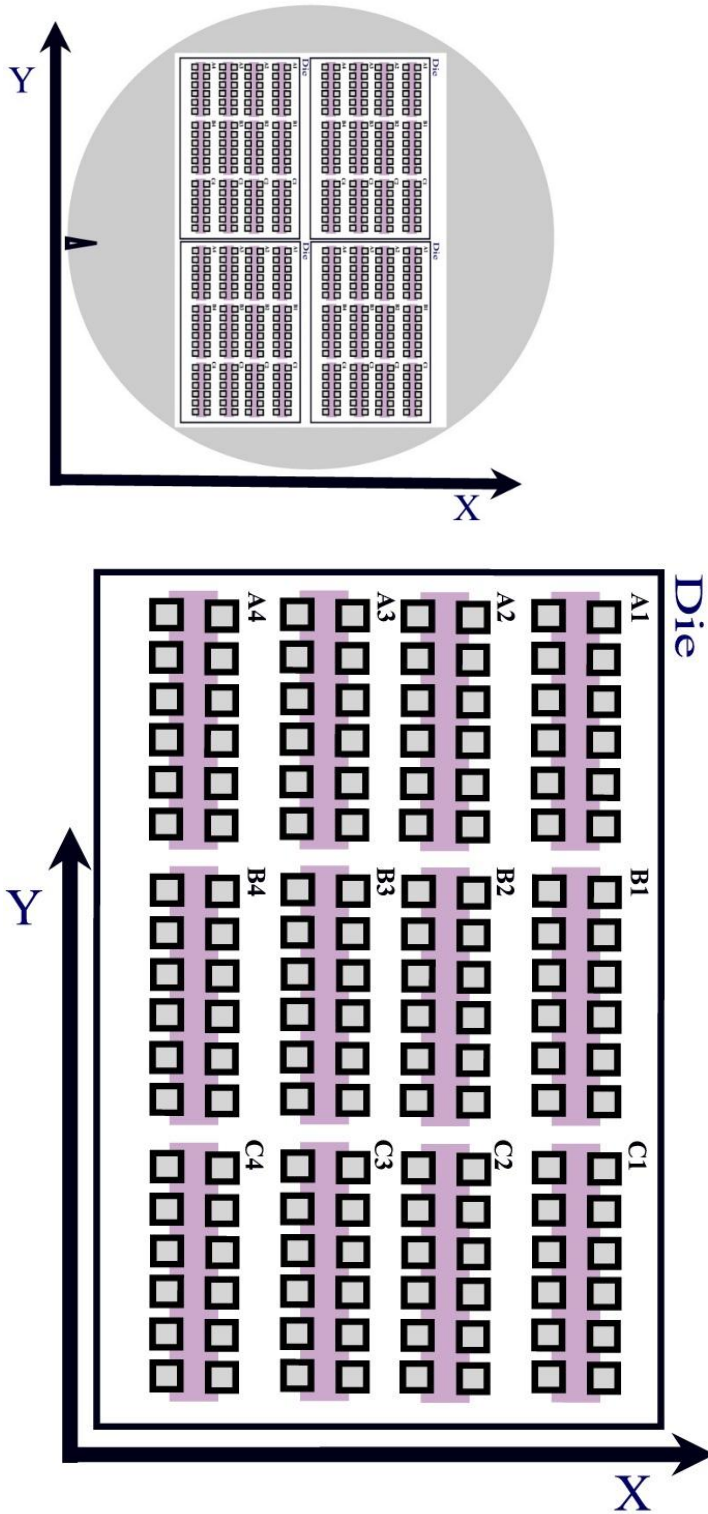

Creating a Module List

The module list is created by using the Module List Editor found in the Development menu of Metrics ICV. All distances used in the Module List Editor are in microns. In addition the distances are defined as the distance to move from one module to another. This is illustrated in the following diagram:

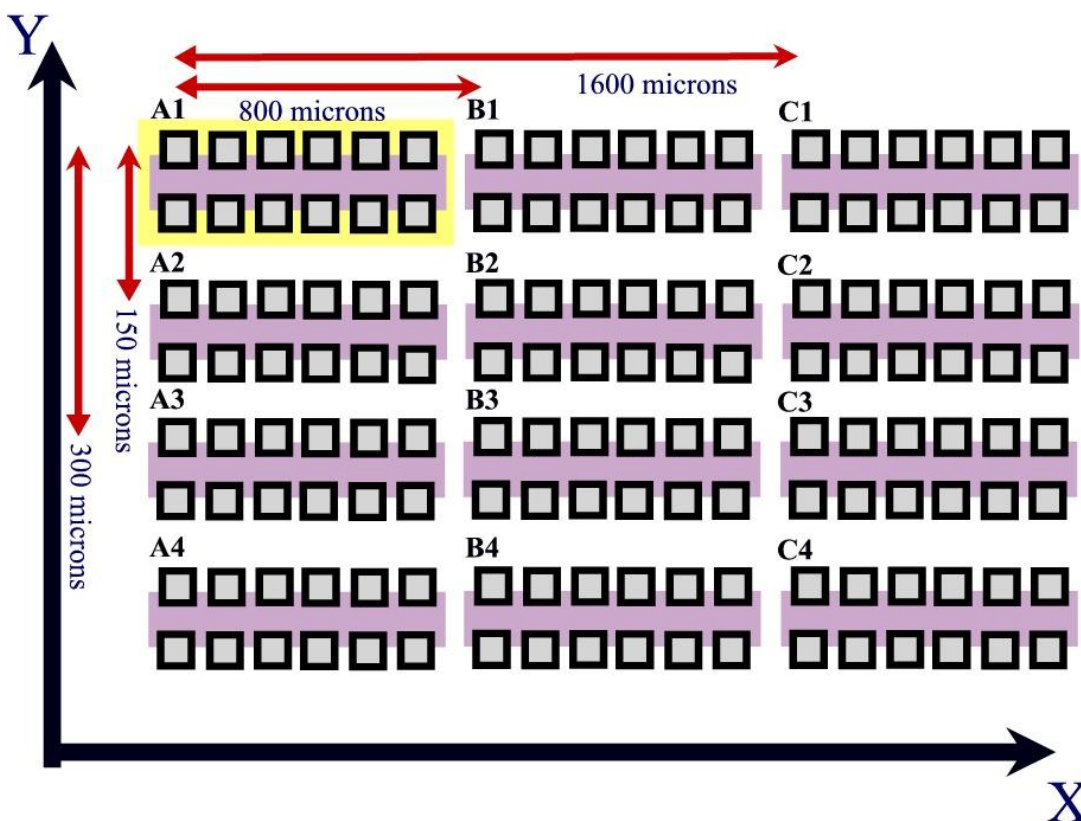

In the above diagram the module named A1 is treated to be the reference location. **The reference location (0,0) is the location that the wafer MUST be positioned to when starting an automated test.** In the case of auto probe stations, the station must be programmed to load to this module when the load command is sent to it. The location of the reference location is up to the user. However, the user should not change the reference location unless they erase all old maps. Otherwise the previous maps will not function correctly.

Based upon the diagram and the coordinate system, the Modules would be defined as:

Module Name	X Coordinate	Y Coordinate
A1	0	0
A2	800	0
A3	1600	0
B1	0	-150
B2	800	-150
B3	1600	-150
C1	0	-300
C2	800	-300
C3	1600	-300

Note that the reference location is ALWAYS defined as 0,0.

To Create a Module List

1. Open the Module List Editor. Select **Module List Editor** from the Development menu or click the **List** button in the Module area of the Metrics ICV navigation window.

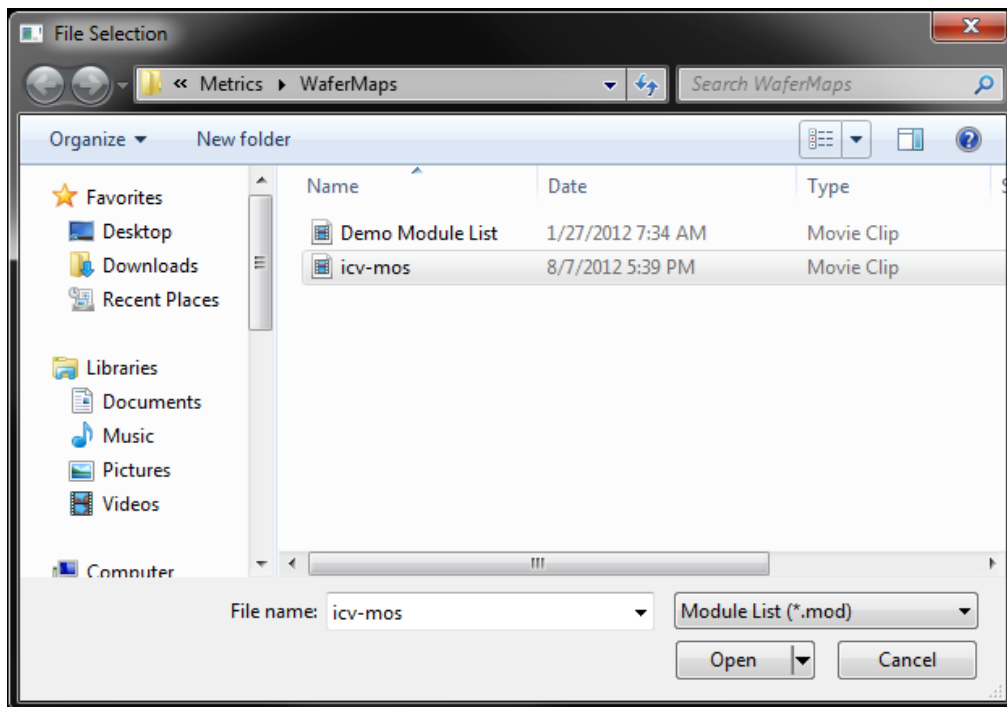

2. Enter a name for the new module list and click the **Open** button.

3. The Module List Editor will now open.

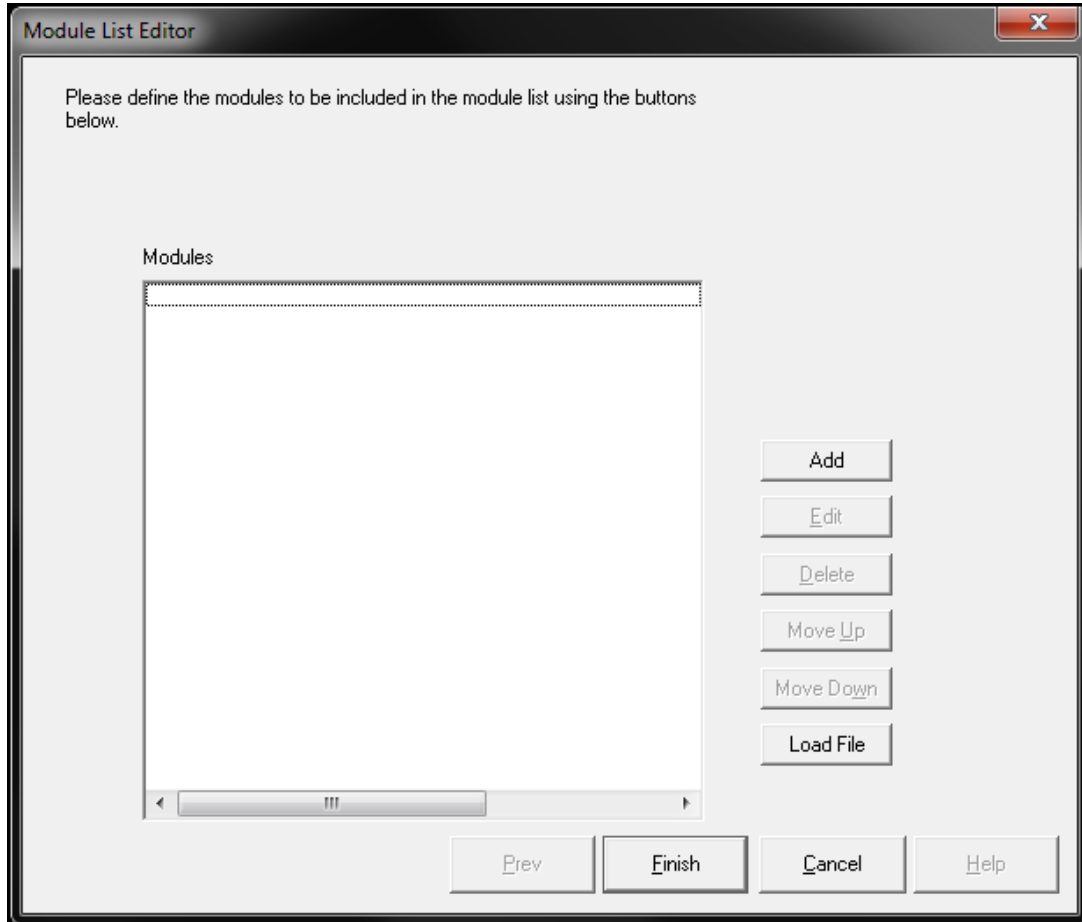

4. Click the **Add** button to add a module location.

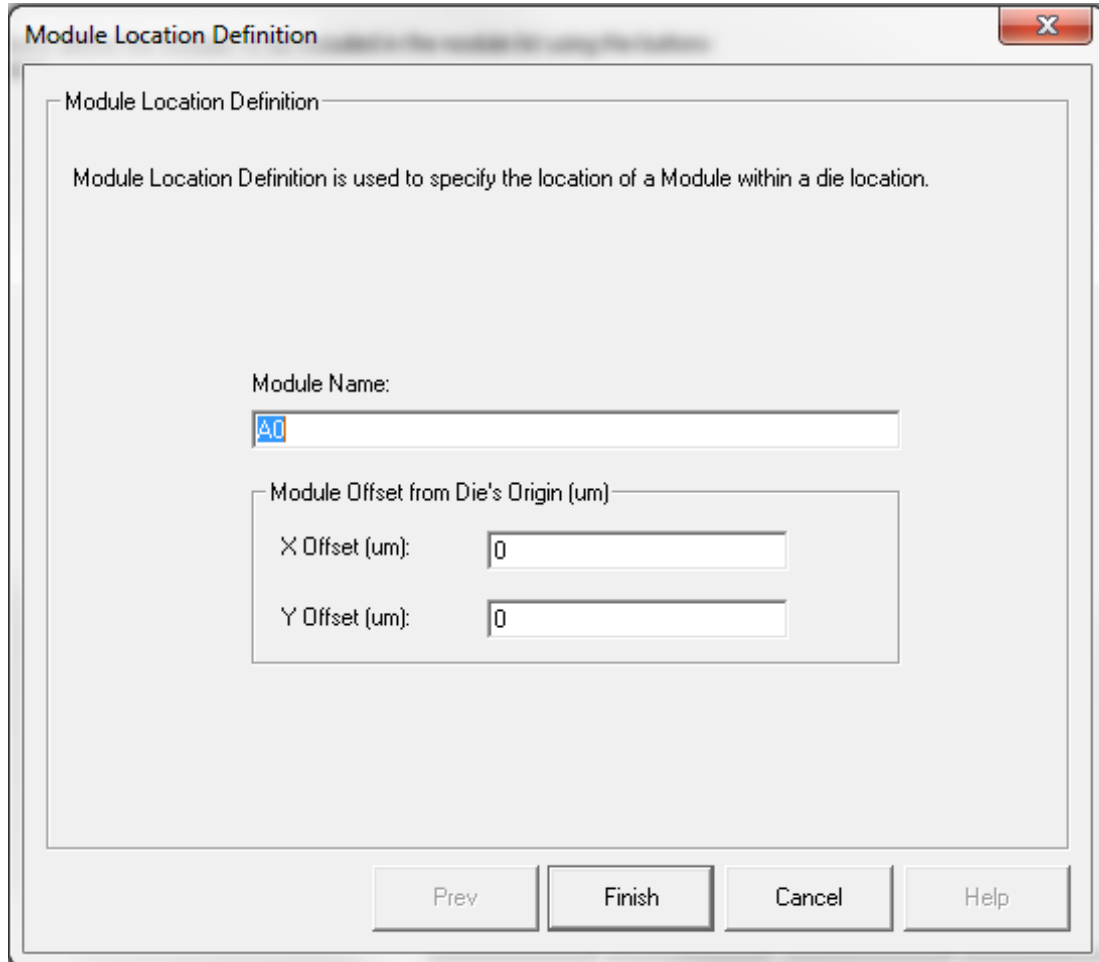

5. Enter the **Module Name**, **X Offset**, and **Y Offset** and click **Finish**.

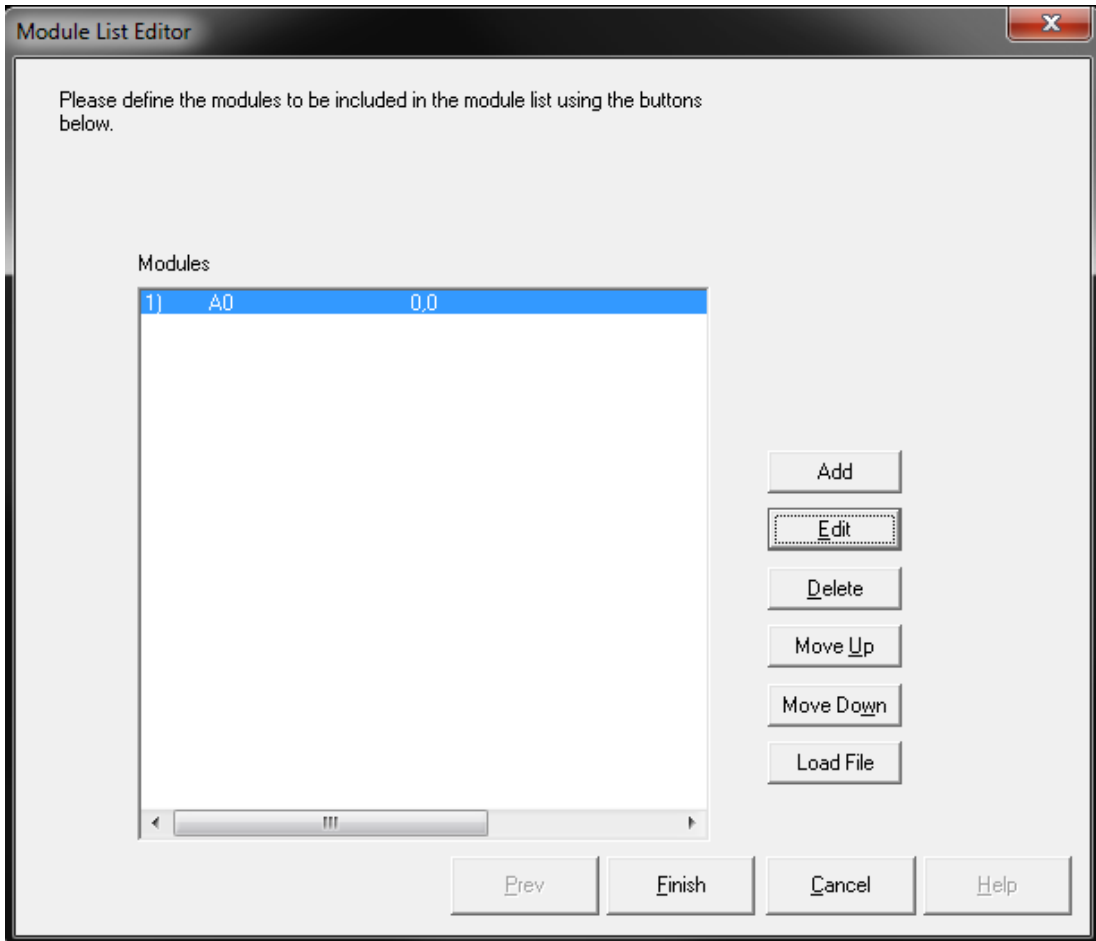

6. The location will be added to the list.

7. Repeat steps 4-6 to add more locations.

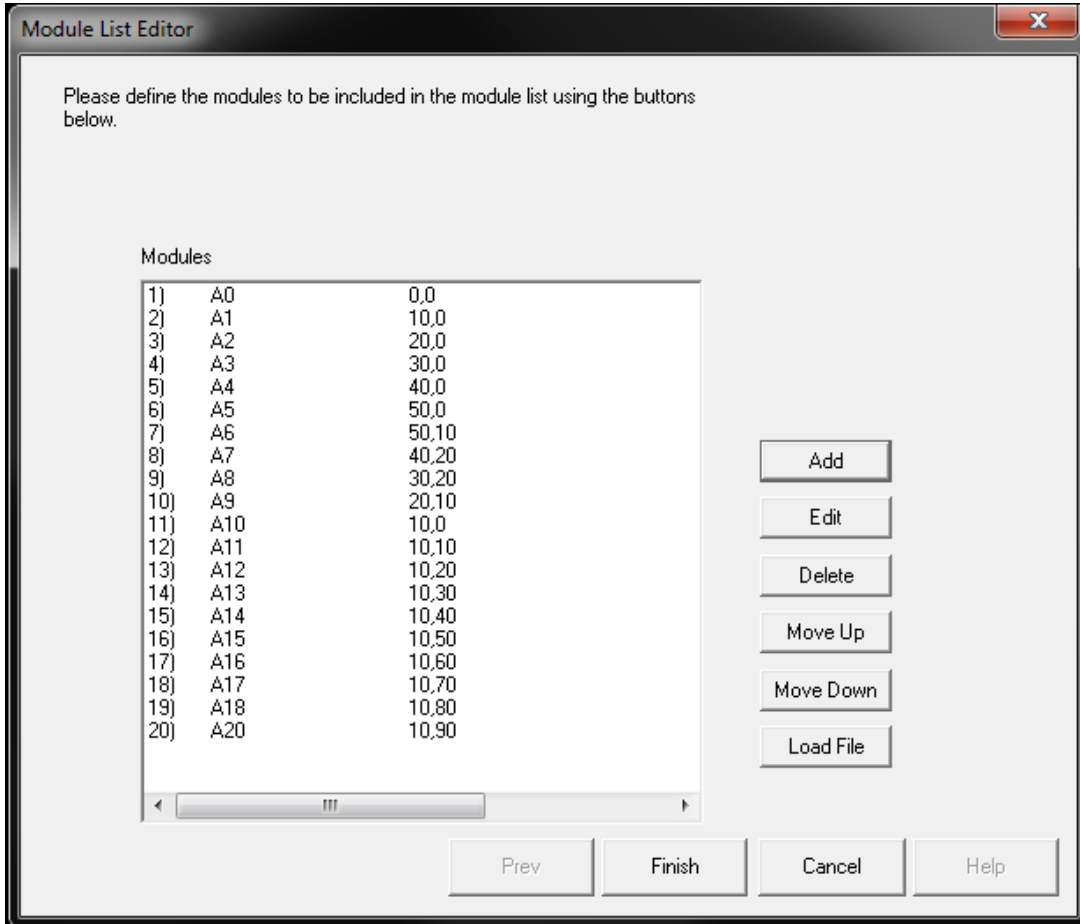

8. Click the **Finish** button to save the module list.

Importing a Module List

The Module List Editor is able to import a list of module locations from a .TXT file. The file must use one of the following delimiters for the data: comma, space, or tab. After each entry must be a carriage return.

If the file contains duplicate entries the duplicates will be ignored. For the locations listed above, the following data formats would be acceptable:

Comma Delimited

A1,0,0
A2,800,0
A3,1600,0
B1,0,-150
B2,800,-150
B3,1600,-150
C1,0,-300
C2,800,-300
C3,1600,-300

Tab Delimited

A1<Tab>0<Tab>0
A2<Tab>800<Tab>0
A3<Tab>1600<Tab>0
B1<Tab>0<Tab>-150
B2<Tab>800<Tab>-150
B3<Tab>1600<Tab>-150
C1<Tab>0<Tab>-300
C2<Tab>800<Tab>-300
C3<Tab>1600<Tab>-300

Space Delimited

A1 0 0
A2 800 0
A3 1600 0
B1 0 -150
B2 800 -150
B3 1600 -150
C1 0 -300
C2 800 -300
C3 1600 -300

Chapter 7- Creating a Die Test

Introduction

The next step in creating a test plan is to build a die test script out of the module list and module test scripts. The die test designates the order in which actions occur during testing of a die.

Topics Covered

- What is a die?
- What a die test does
- Creating a die test sScript

What is a Die?

The definition of a die within Metrics ICV is the repeating unit on a wafer. All stepping inside of this repeating unit is handled by the module list.

What a Die Test Does

A die test is the testing plan for the modules within the die. The die test directs the probe station to step to a specific module and then run the selected module test at that location.

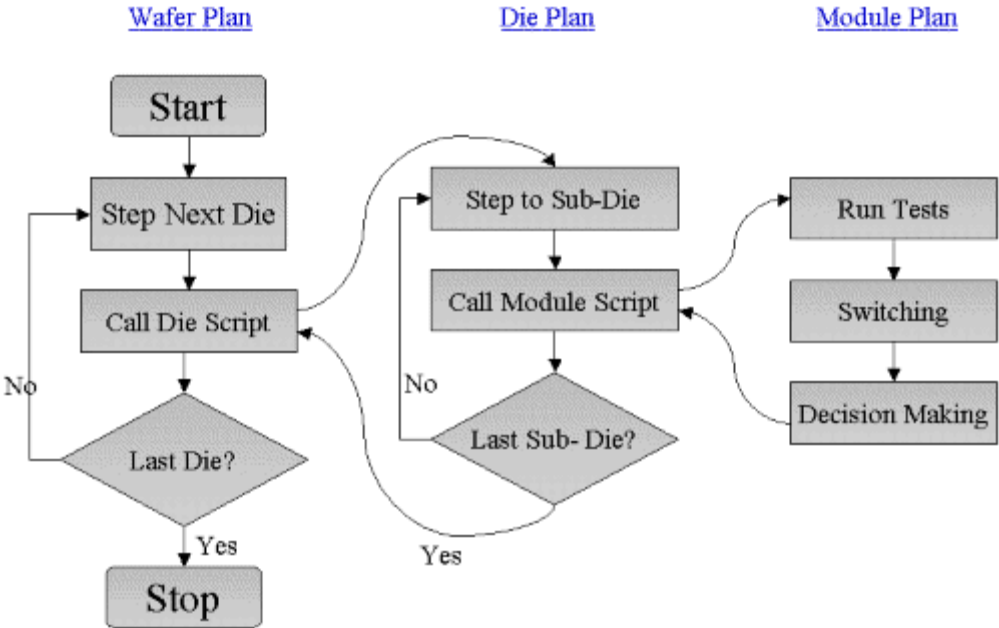

Creating a Die Test Script

The die script coordinates the sub-die stepping of the probe station with the execution of module scripts. If testing is to be performed upon only a single module per die, then the die test script will only contain a single stepping call.

To Create a Die Test

1. Open the Die Test Editor from the Development menu or click the **Test Script** button in the Die area of the Metrics ICV navigation window.

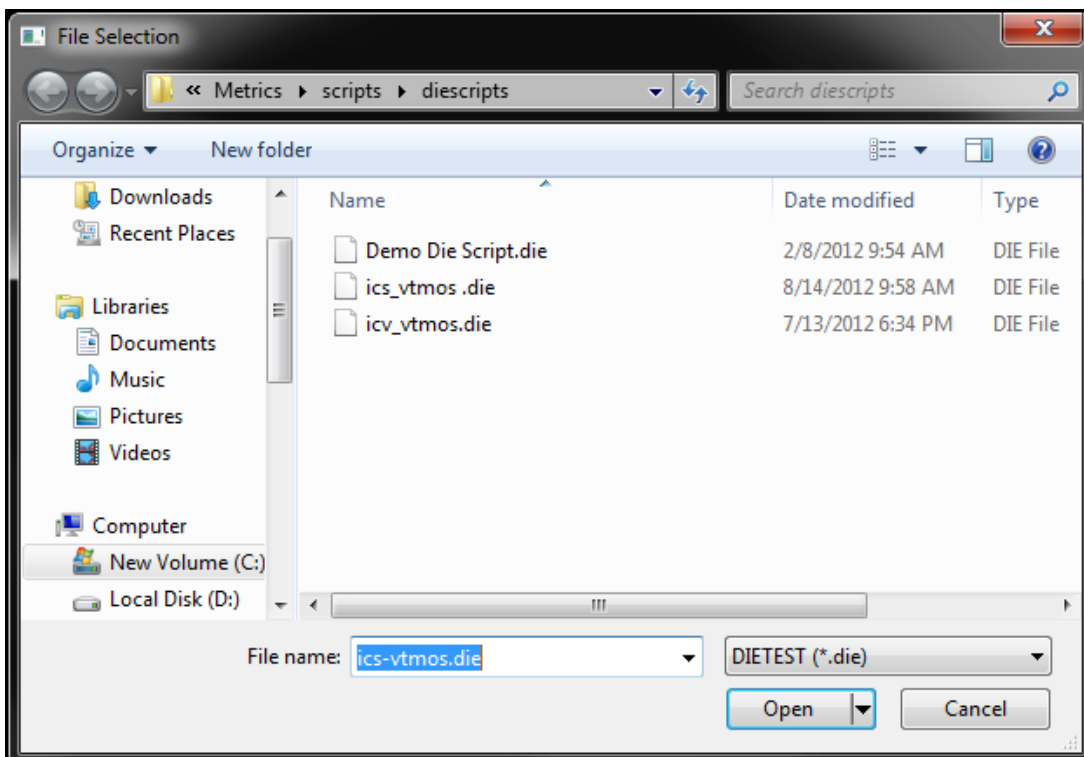

2. Type a new file name or open a die script file to edit.

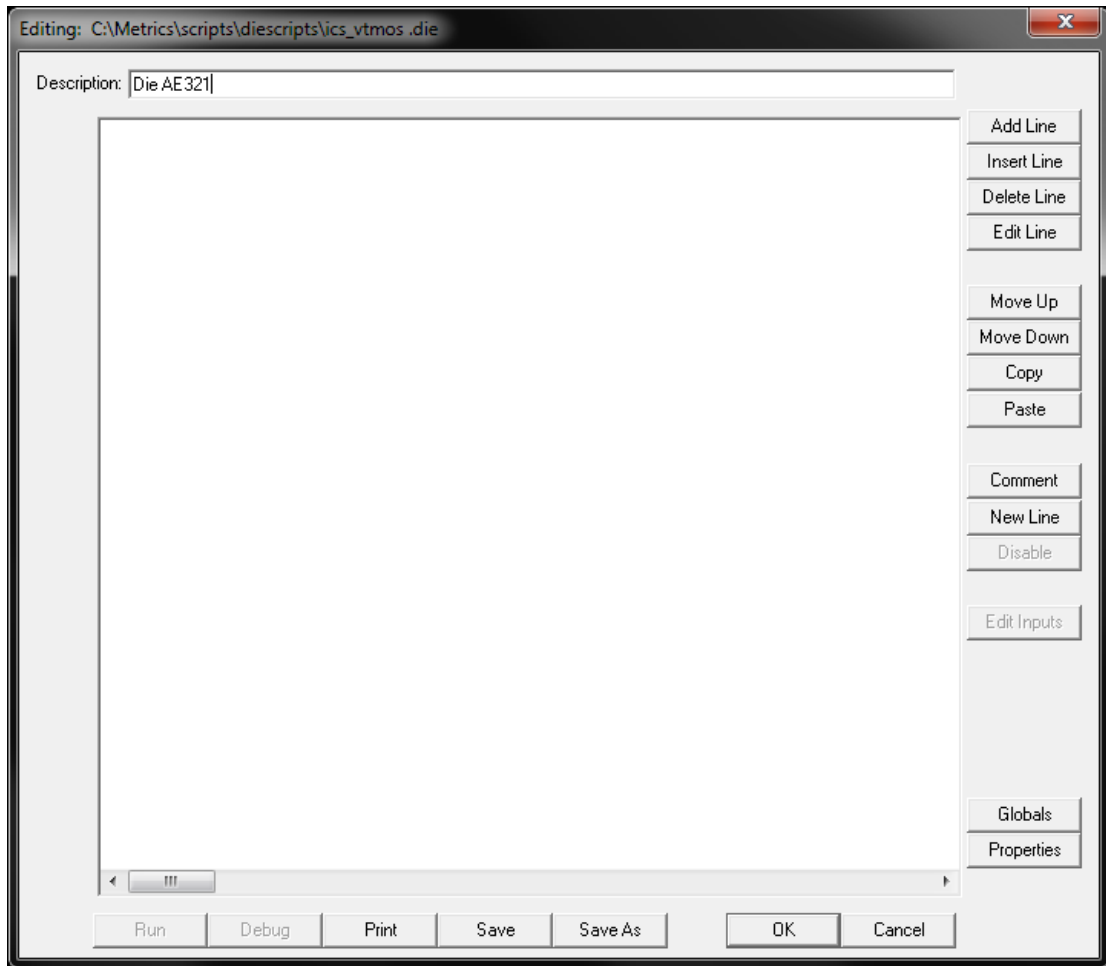

3. Enter a **Description** and then click the **Add Line** button.

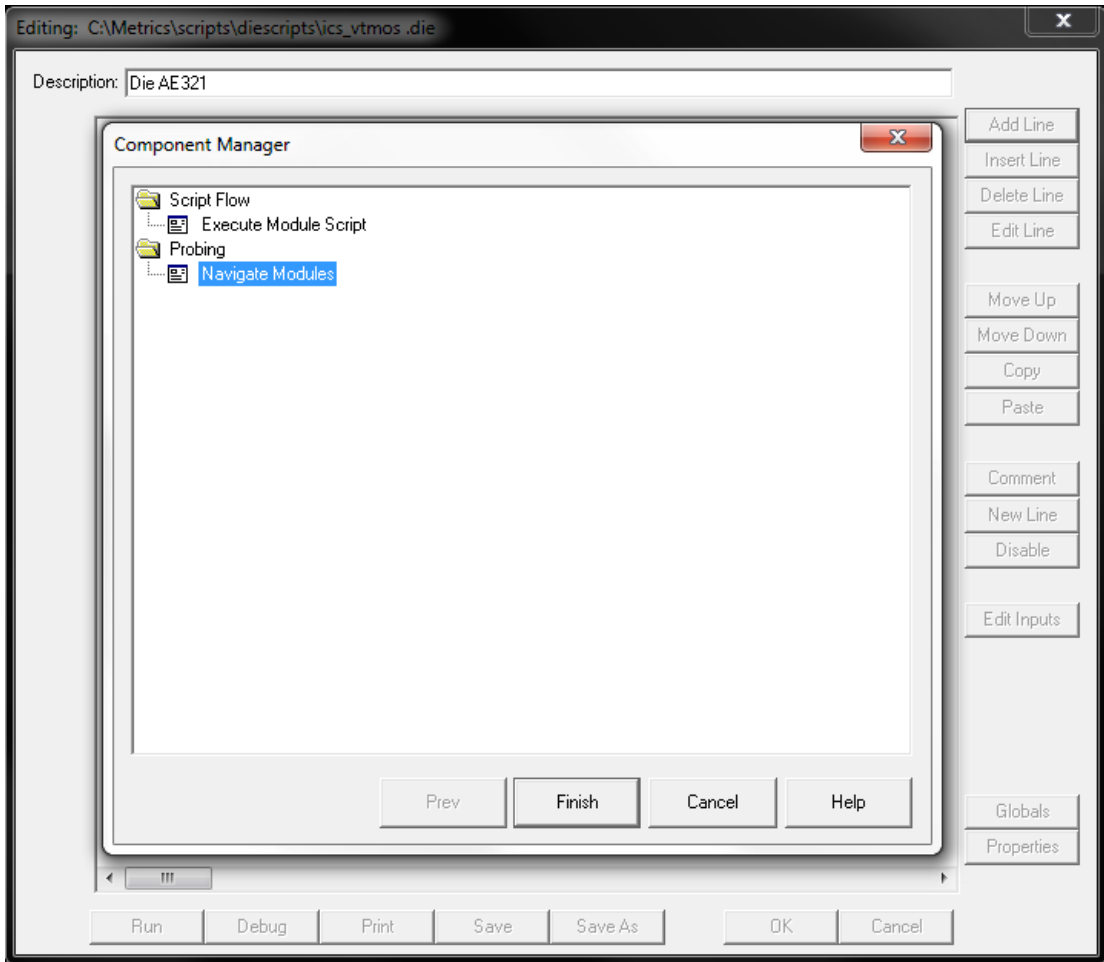

4. Select the **Navigate Modules** item and click the **Finish** button.

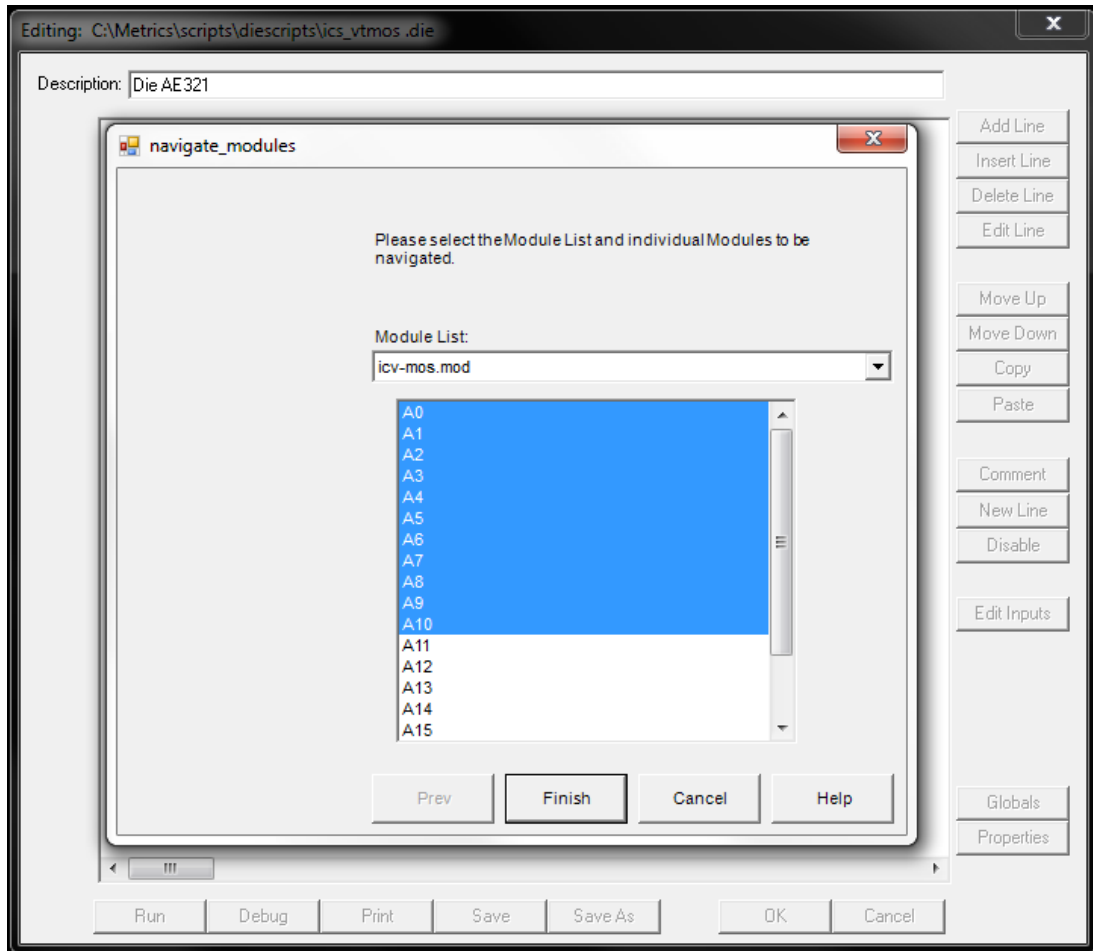

5. Select the module list to use and highlight the specific module you want to step to by selecting the first module and then using Shift-Click to select the last module.

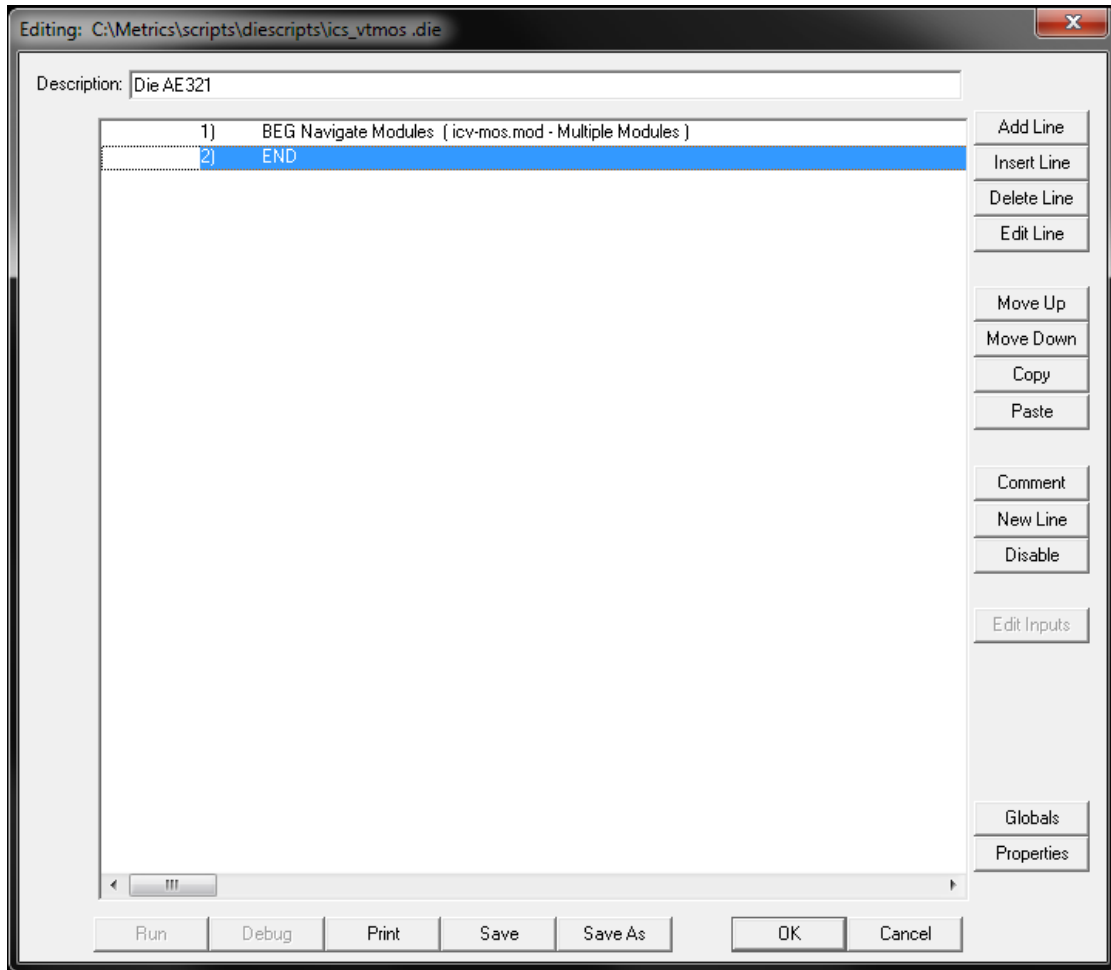

6. The script will be updated to show the movement. Highlight the END statement in the script and click the **Insert Line** button.

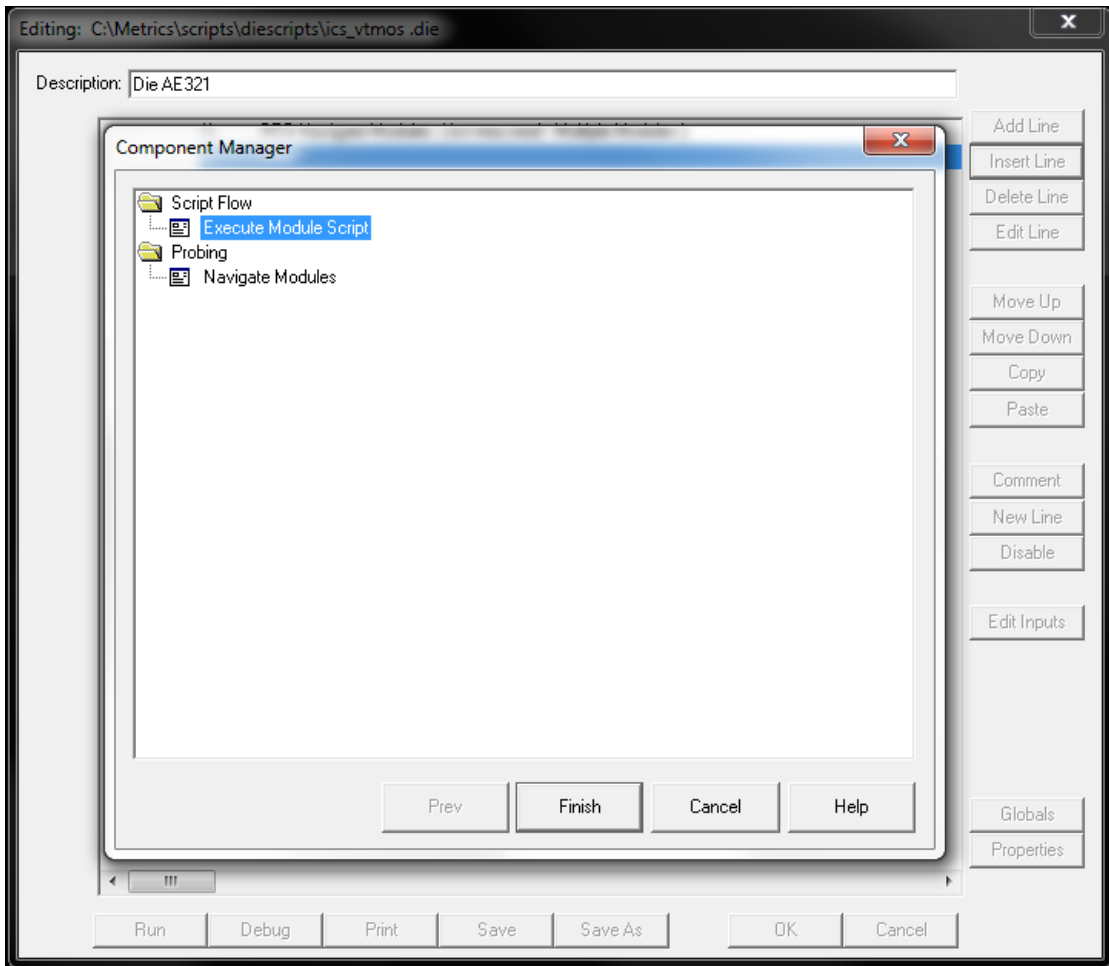

7. Select the **Execute Module Script** item and click the **Finish** button.

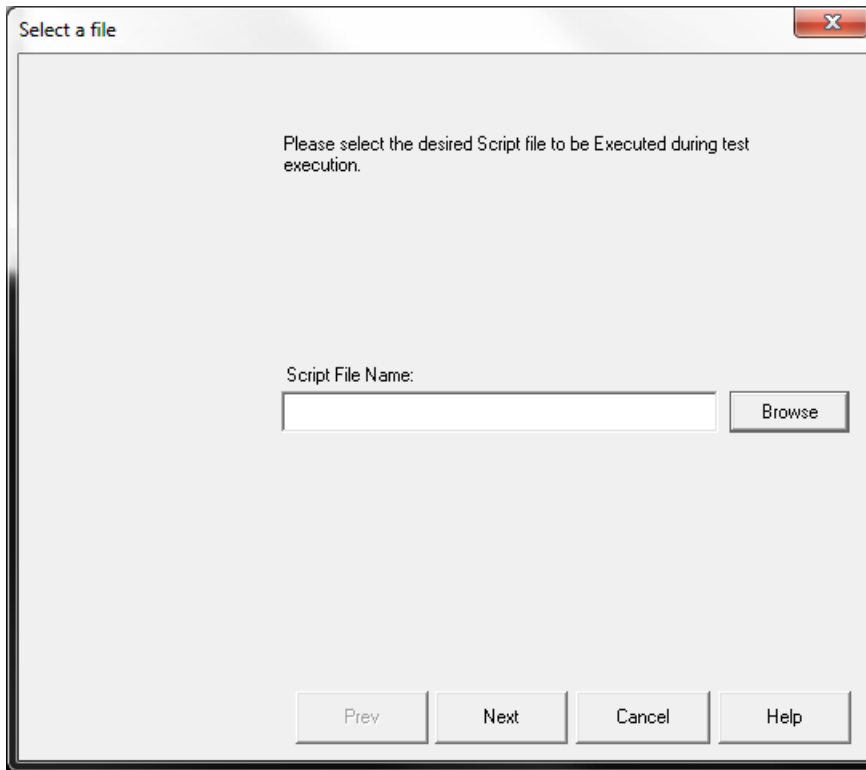

8. Click the **Browse** button to open a dialog box to select the module test.

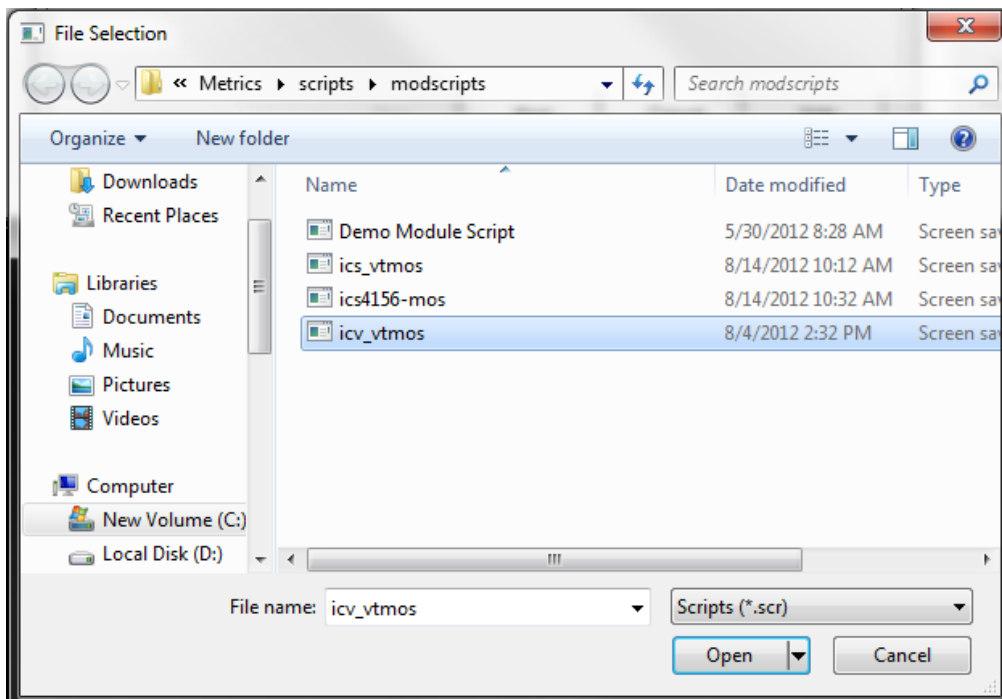

9. Select the module script then click the **Open** button to select the module test script.

10. Click the **Next** button to add the module script to the die test script.

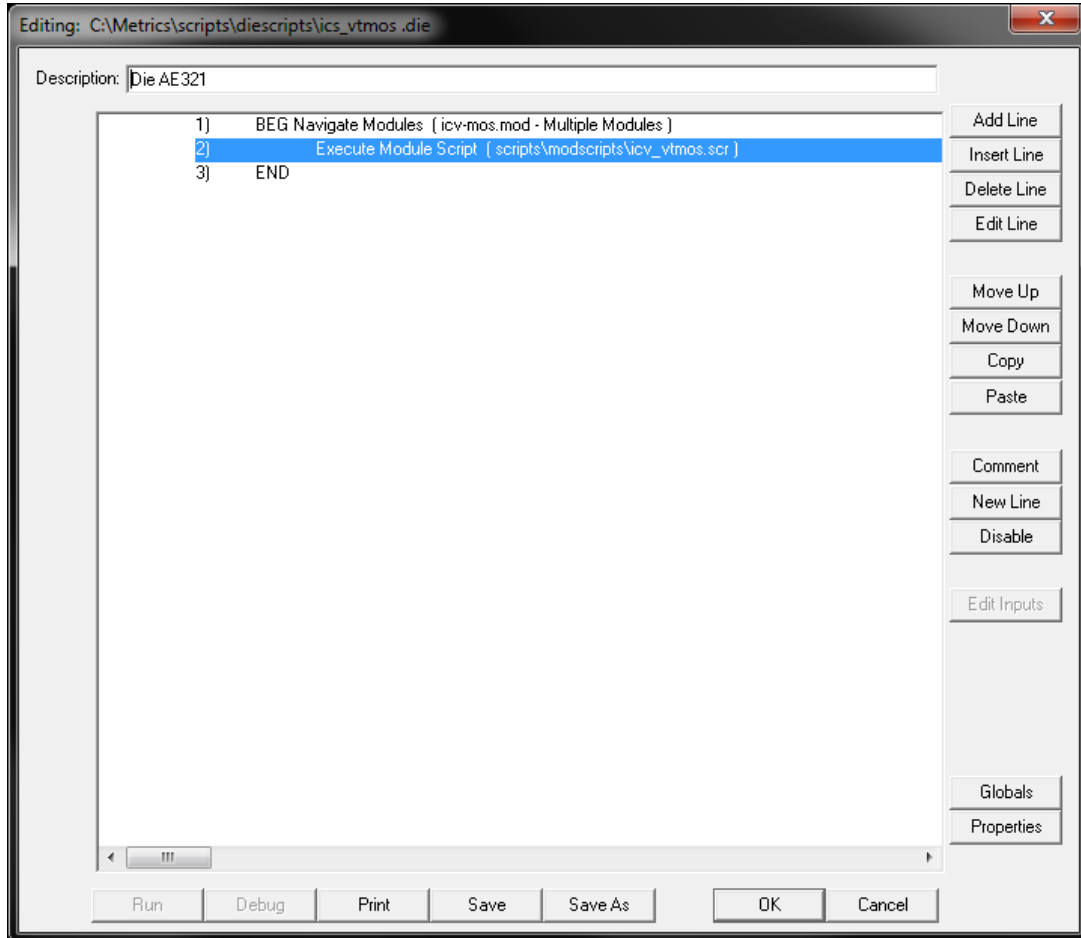

11. Repeat the process for all additional modules you wish to test.

Chapter 8- Creating Wafer Maps

Introduction

At this point all of the methods have been defined and it is time to pick the die that this testing will be performed upon.

This chapter details the how and what of probing in Metrics ICV. Features of the Wafer Map Editor will be demonstrated. Several of the probe stations that Metrics ICV supports have their own software, if necessary that software must be configured to accept GPIB control. Metrics ICV does not support using wafer maps within the probe station vendor's software.

Topics Covered

- Creating a probe plan with the Wafer Map Editor
- Verifying the wafer map

Creating a Probe Plan with the Wafer Map Editor

Metrics Wafer Map Editor is the probing application designed by Metrics Technology to control probe stations. This editor will take information regarding the wafer and die size to produce a graphical representation of the wafer. The die locations to be tested along with the reference die and coordinate system can also be specified.

The steps to create a probe plan are:

1. Select **Wafer Map Editor** from the Probing menu or click on the **Map** button under the Probe area of the Metrics ICV navigation window.

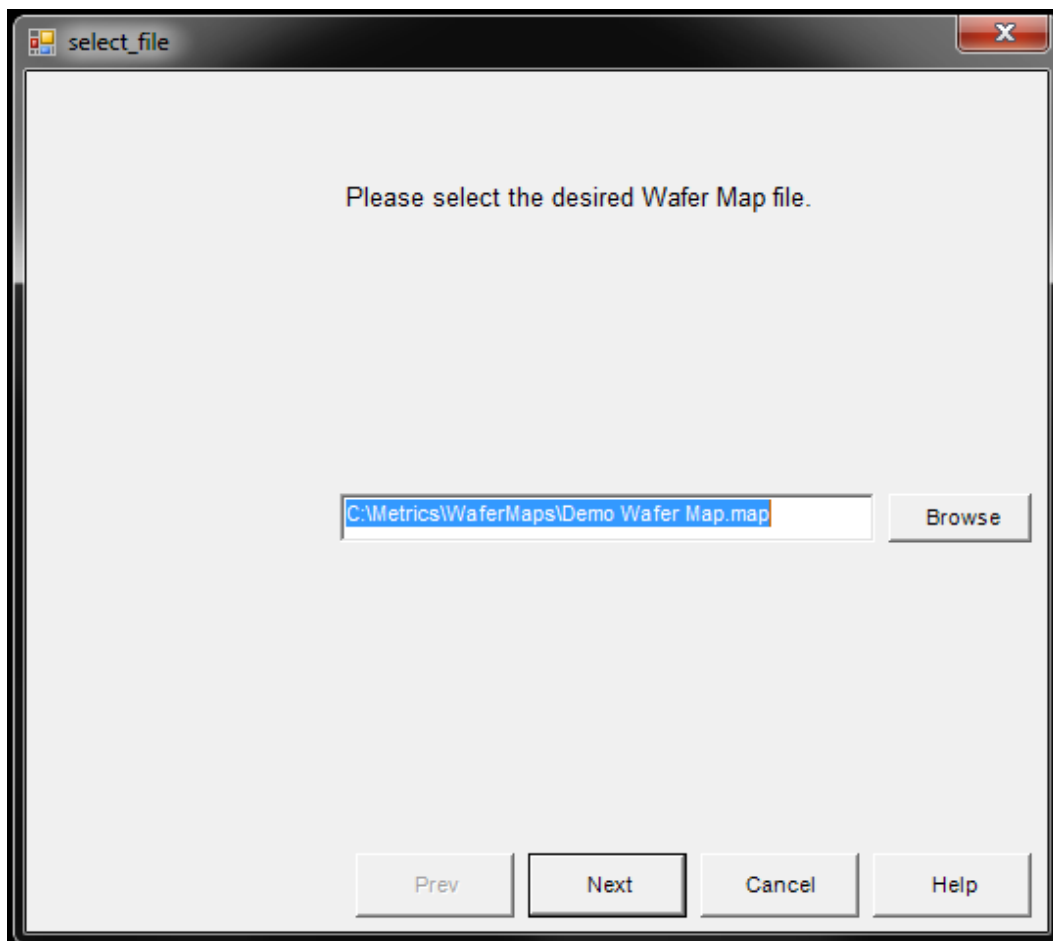

2. Enter a name for the new map and click the **Next** button.

Note: All maps must be stored in the Metrics\Wafermaps directory.

Wafer Map Definition

Please specify the wafer map dimensions, flat location, and navigation options, and Wafer Center adjustments in the fields below.

Wafer Definition

Units:

Wafer Size:

X Die Size:

Y Die Size:

Flat Location:

Don't Display Wafer Border

Navigation Options

Starting Location:

Bi-Directional Movement

Uni-Directional Movement

Move by Row

Move By Column

Wafer Center Definition

Auto Center

Center On Die

Center On X and Y Streets

Center On X Street, Y Die

Center On Y Street, X Die

Fine Centering:

X Offset (um):

Y Offset (um):

Prev Next Cancel Help

3. Enter the wafer information. The Wafer Definition section is required. The Navigation Options allow for the control of the stepping direction of the probe station. Most users leave these as default. The Wafer Center Definition allows the adjustment of the wafer drawn by the Wafer Map Editor so that the map more accurately reflects the actual wafer. (see the Technical Reference Manual for further discussion of these features).
4. Click the **Next** button to continue.

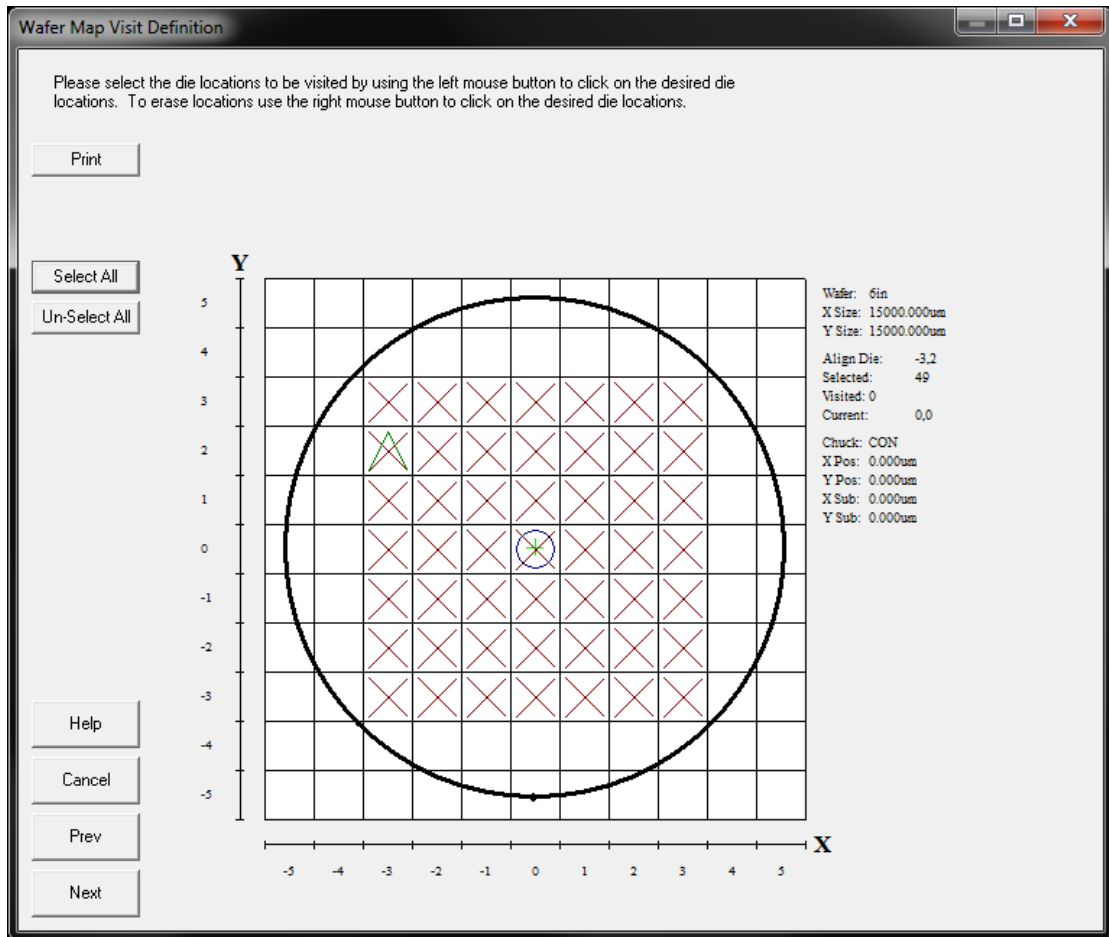

5. Click the **Left** mouse button to select the die locations that will be tested. The **Right** mouse button can be used to un-select a location. Click the **Next** button after selecting the tested die.

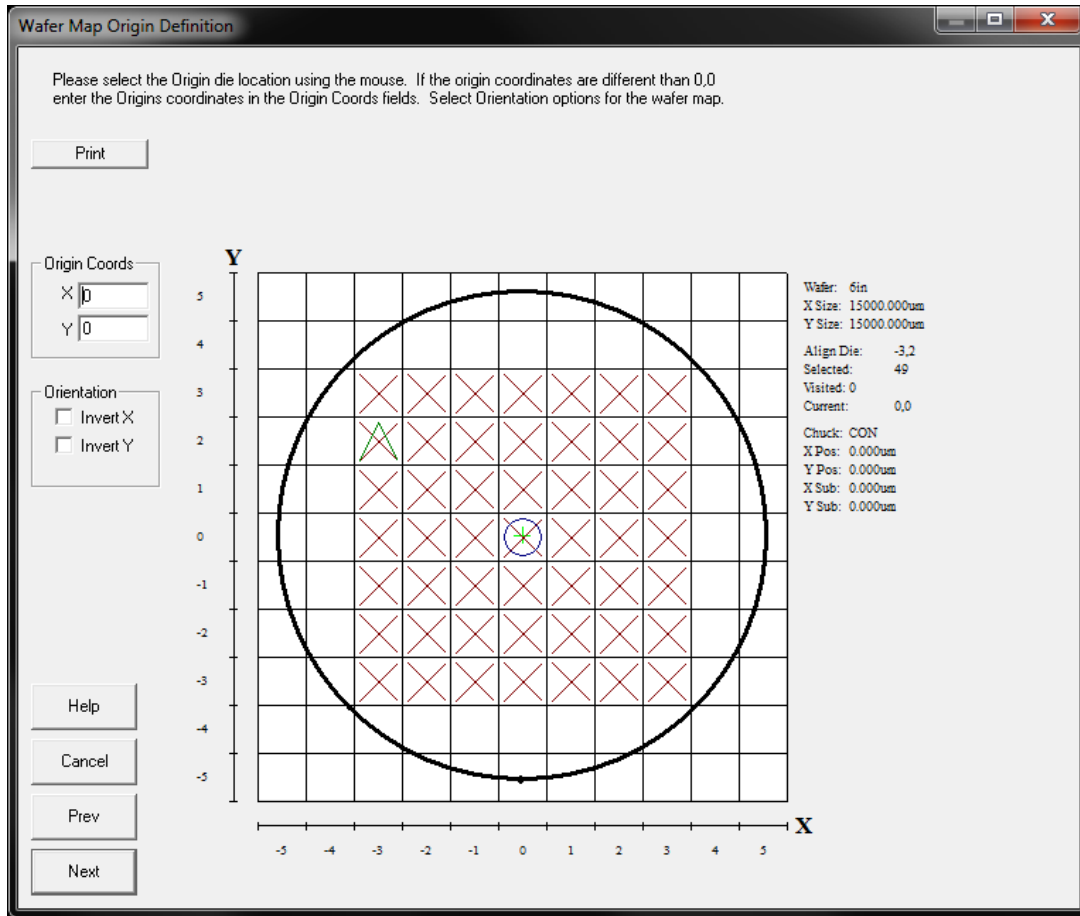

6. Use the **Left** mouse button to select the location of the coordinate system origin.
7. Click the **Next** button to continue.

Note: If you are using a fully automatic probe station, make sure your Die numbering EXACTLY matches the die numbering on the probe station monitor.

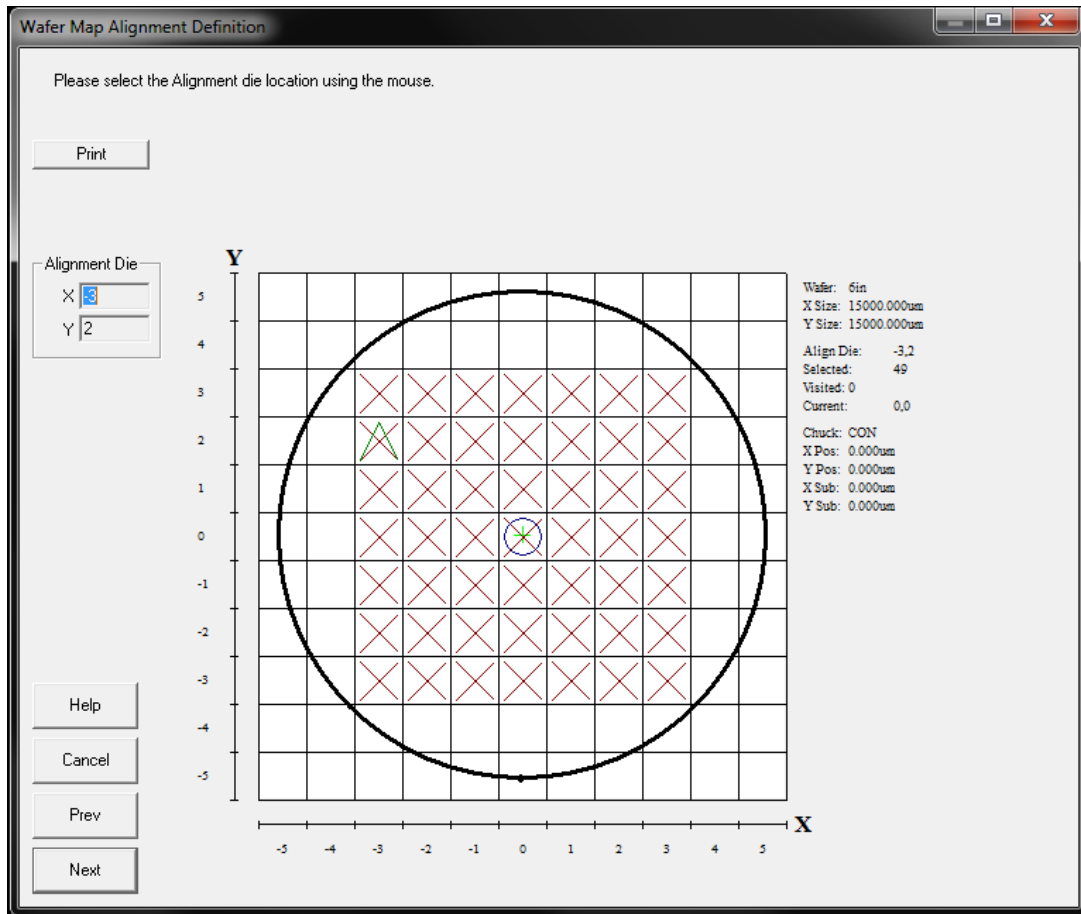

8. Use the **Left** mouse button to select the Reference Die.

Note: The Reference Die is the location that the wafer is loaded to. If this location is not specified correctly you will not step the wafer correctly.

9. Click the **Next** button and the map will be saved.

10. An existing map can be edited by opening it with the Wafer map Editor.

Verifying the Wafer Map

Testing the probe plan is a simple process in Metrics ICV. It is recommended that any new map be tested to avoid long delays while a system collects data you did not intend for it to collect.

Testing the wafer map can confirm:

1. The die size is correct.
2. The reference die location selected is correct.
3. The module list distances are correct.

The steps to verify a probe plan are:

1. Make sure you have already loaded the first wafer onto the chuck and it is ready to go (aligned, at reference die, etc.).
2. Make sure your probe station has a defined contact and separation height and they are not the same. Typically this is done by clicking a **Contact** and **Separate** button on the probe station or the probe station's software.
3. Select the **Control** button under the Probe area on the Metrics ICV navigation window.
4. Select the wafer map file to test and click the **Open** button.

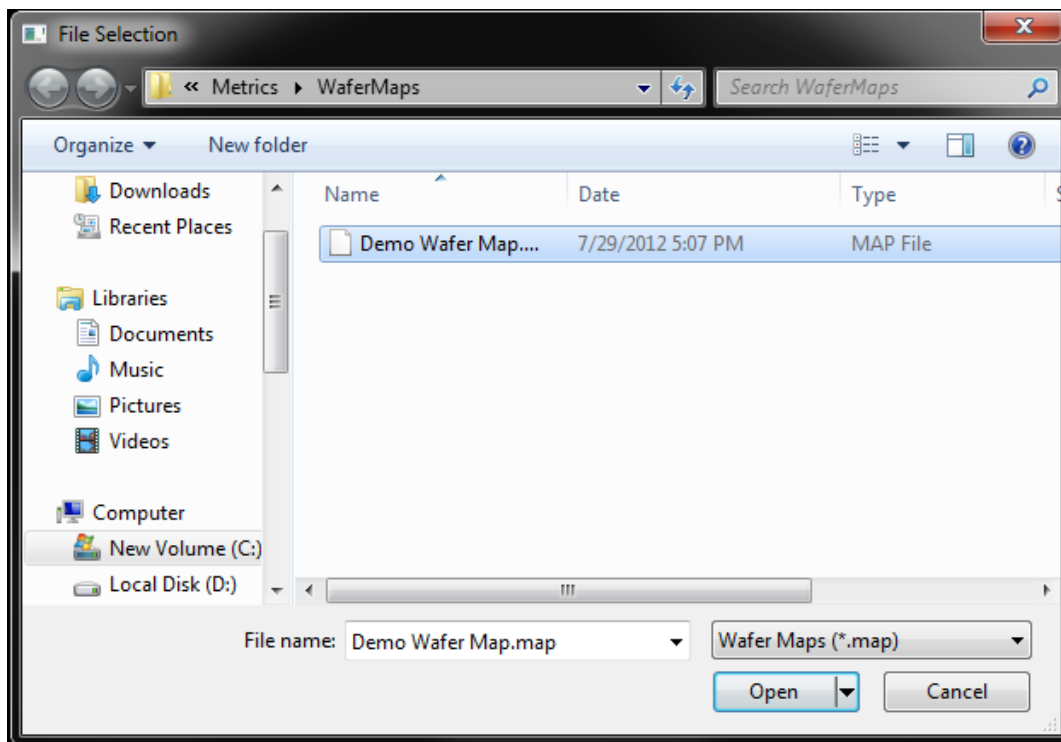

5. The Interactive Wafer Map Navigation Window will open.

Note: During this time the map will try to communicate with the probe station. If you receive an error, make sure the probe station is ready to perform GPIB communication.

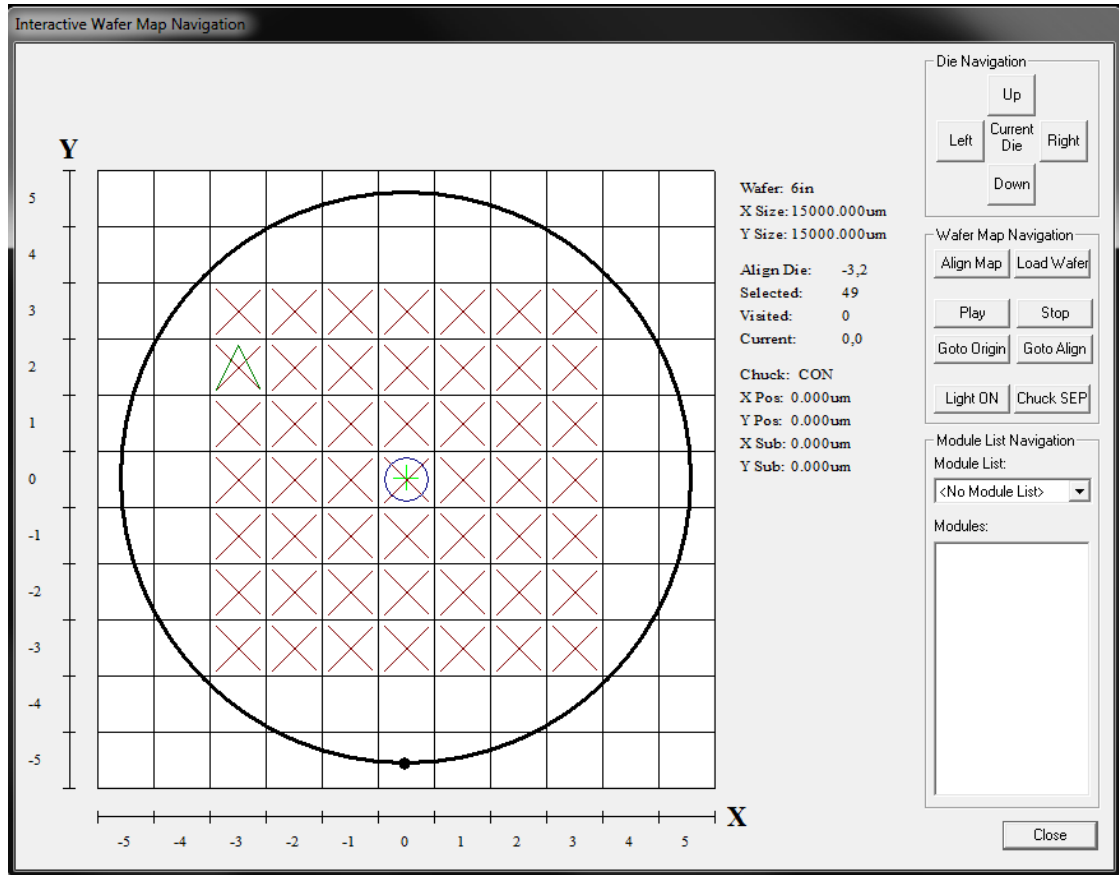

6. Select the **Module List** to be used from the pull-down list.

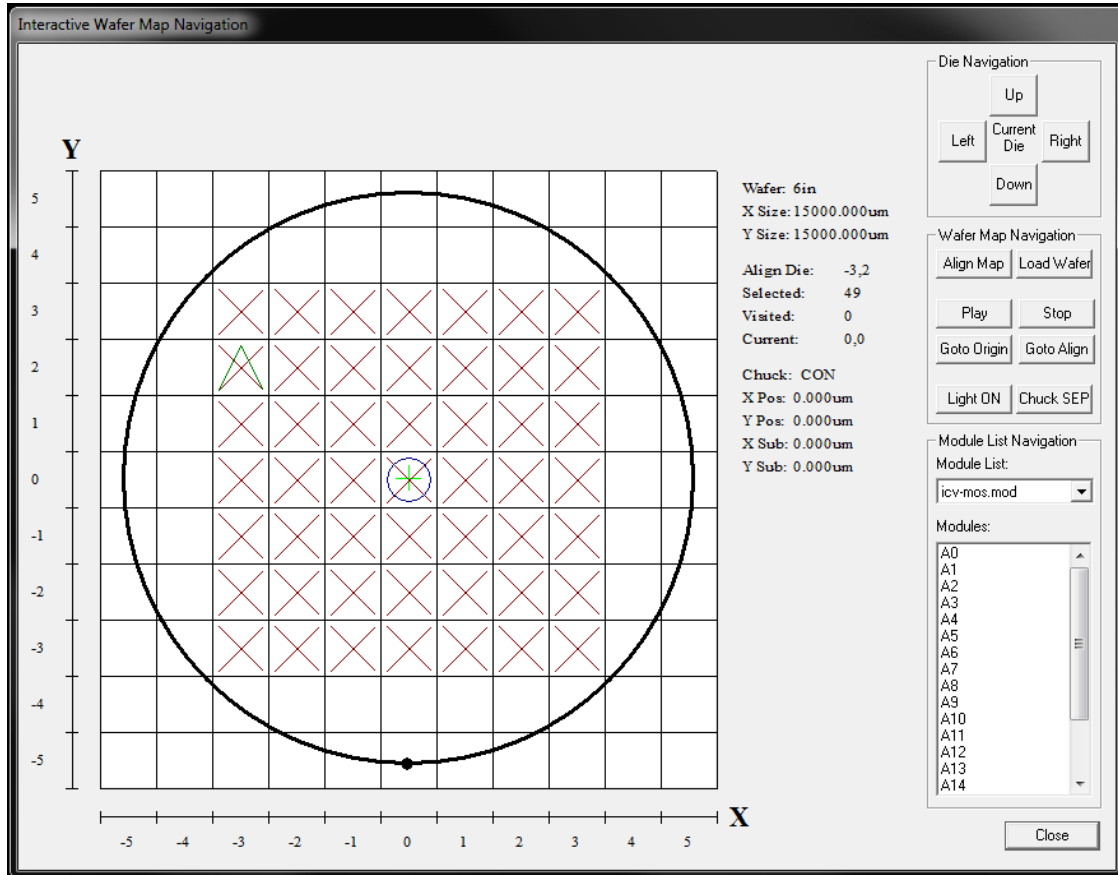

7. Click the **Align Map** button and verify that the wafer is over the reference die. Use your microscope or video to check this. If using a semi-automatic probe station, make sure the chuck is moved back to contact.

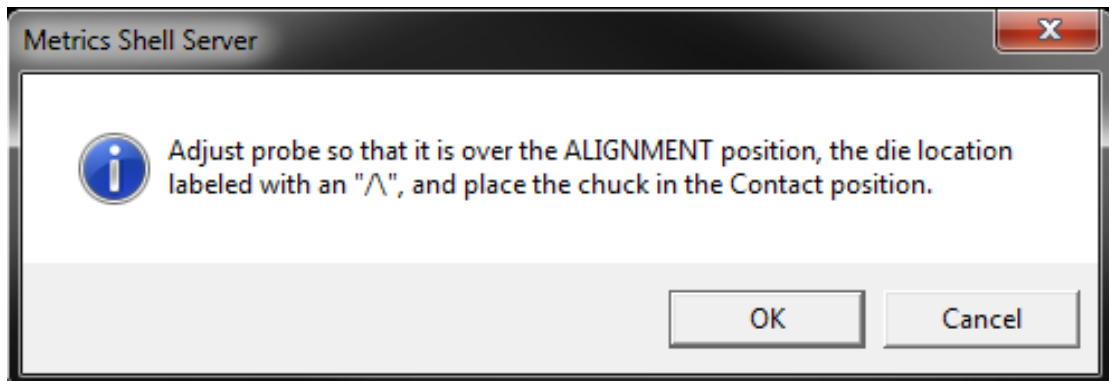

8. Click the **OK** button when finished.

9. The reference die will turn green indicating this is the current location of the probe station.

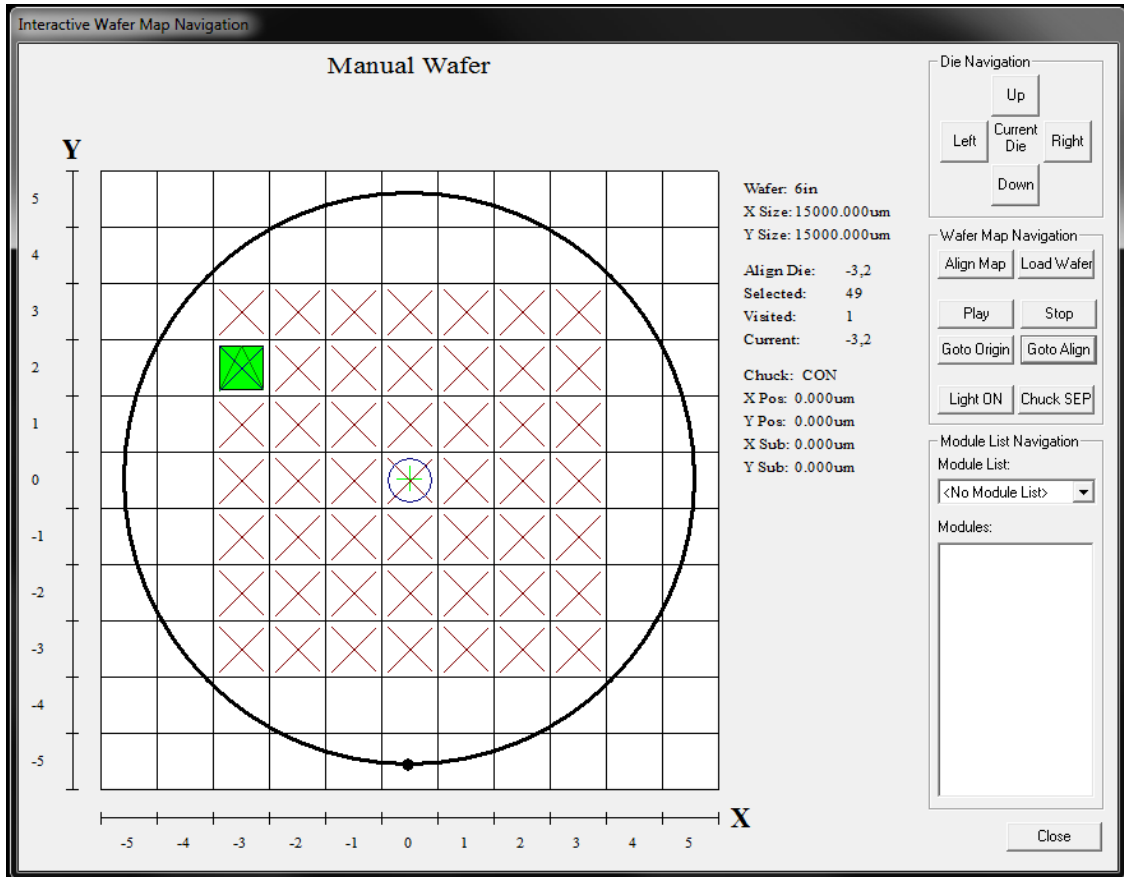

10. Either click the **Play** button to watch the station step through the wafer plan (including module list locations) or double-click the **Die** location you wish to move to. You can also double click the **Modules** locations on the Module List control to move between the sub-site locations.

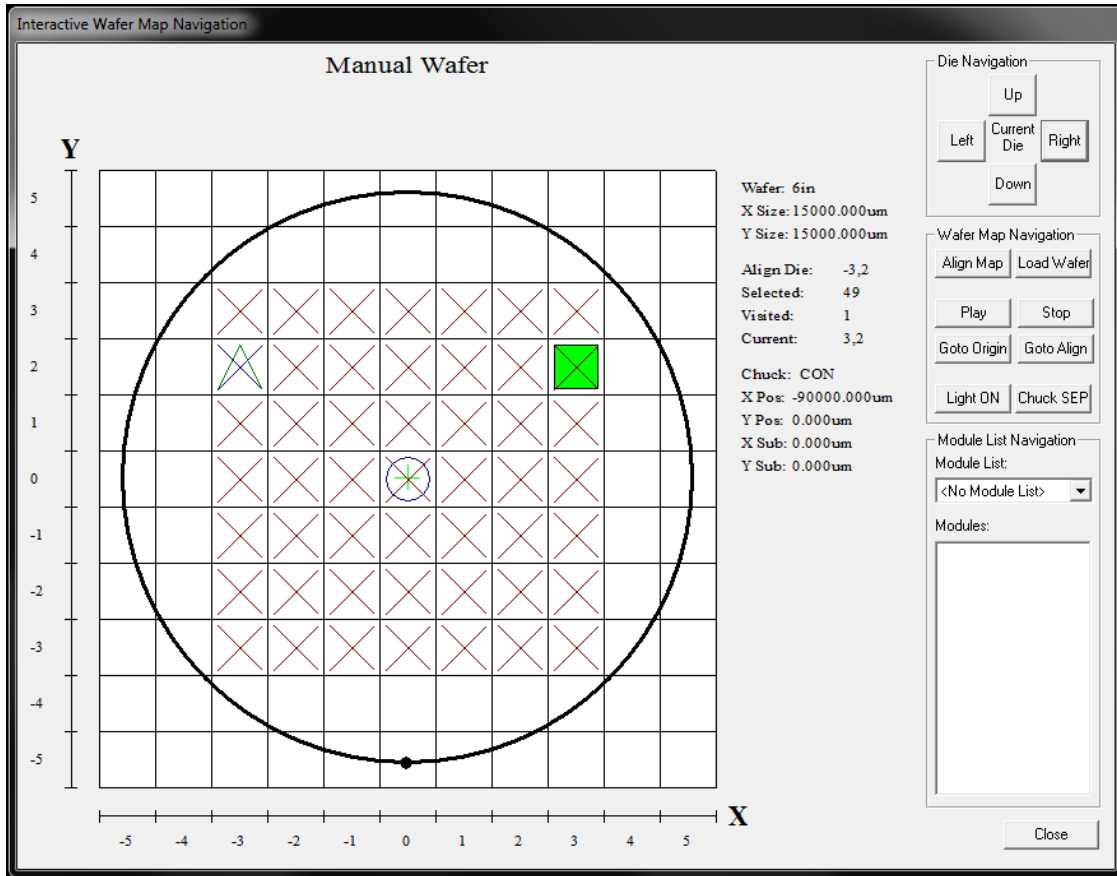

11. Click the **Close** button to end the verification testing.

Hint: Before closing the Interactive Wafer Map Navigation, move the wafer back to the Reference Die and Reference Module.

Chapter 9- Run Test

Introduction

This Chapter demonstrates how to run a test. This section provides information on the daily operation of the Metrics ICV system.

Topics Covered

- Getting a Test Started

Getting a Test Started

Test execution is started by clicking the **Run** button under the Execute area of the Metrics ICV navigation window.

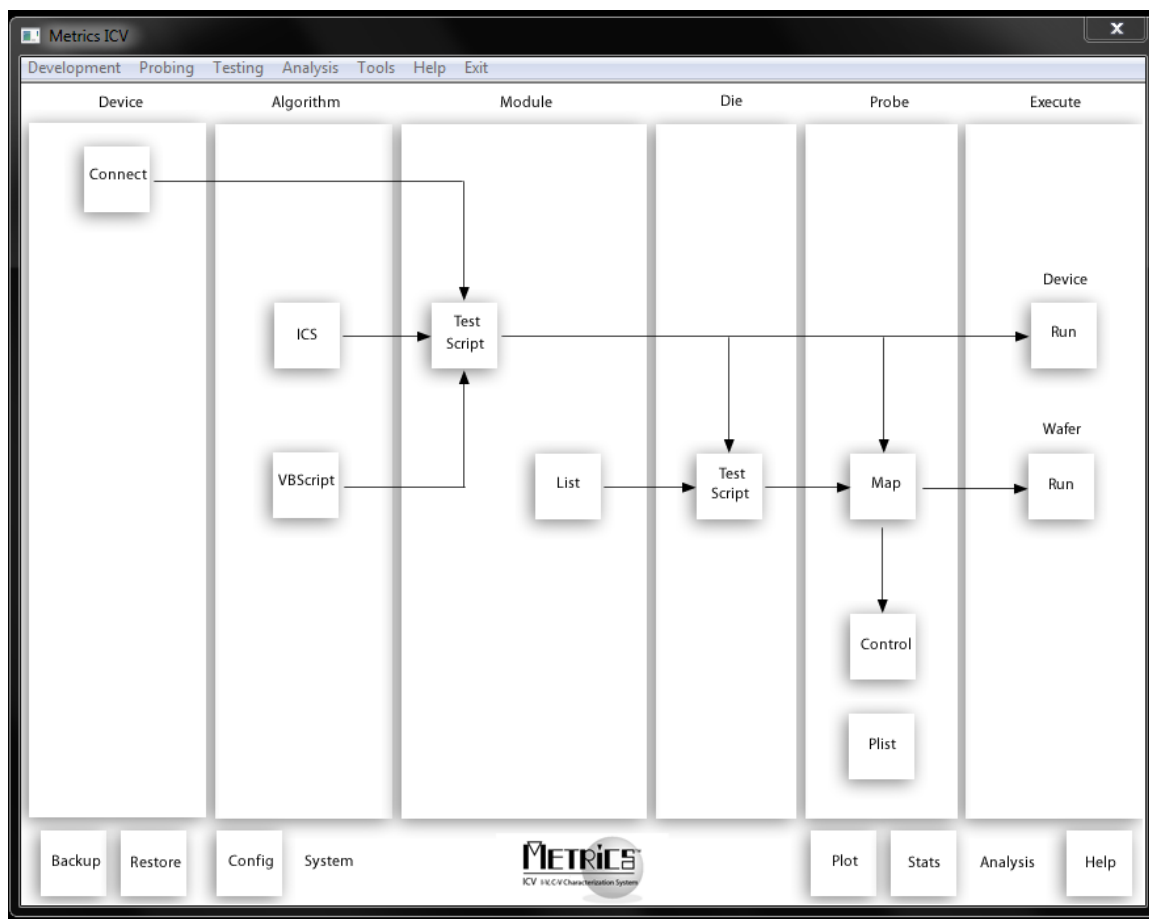

Before clicking **Run** button, one should verify that the following is complete:

1. A wafer map has been created.
2. A die test script has been created.
3. The wafer map has been verified.
4. The wafer (first wafer for fully automatic stations) is loaded, aligned, and at the reference die upon the probe station.
5. All test hardware is turned on and connected via GPIB to the control PC.

To Run a Test:

1. Click the **Run** button on the Metrics ICV window.
2. The Test Execution Setup window will open. Enter the Process, Lot, Wafer, Mask and Operator Information.

Note: These fields are optional but should be used to identify these parameters for the test because they are written to the header in the output data file.

Test Execution Setup

Test Execution Setup

Process: a

Lot: b

Wafer: c

Mask: d

Operator: e

Execute Test: scripts\diescripts\icv_diode.die [Browse]

Save Results in: C:\dev\metrics\bin\data\hp4156-diode-test-08.dat [Browse]

Wafer Testing Configuration

Wafer Map: Demo Wafer Map.map

Use Auto Probers as Semi-Auto Probers

Thermal Configuration

Use Thermal

Controller: TEMP1

Temperature (C): 33

Soak (s): 60

Run Cancel

3. Click the **Browse** button next to the Execute Test field.

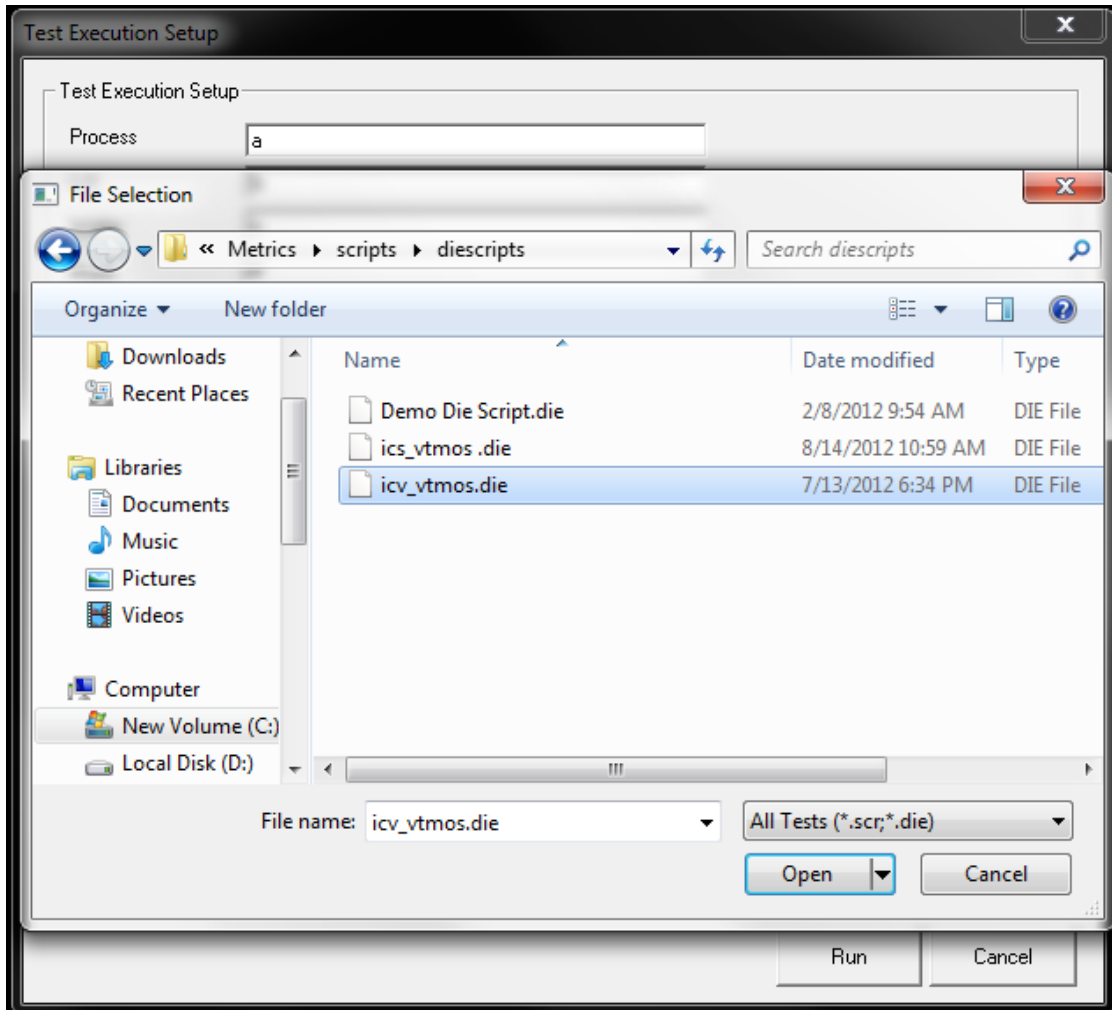

4. Select the **Die** or **Module** script to be run.

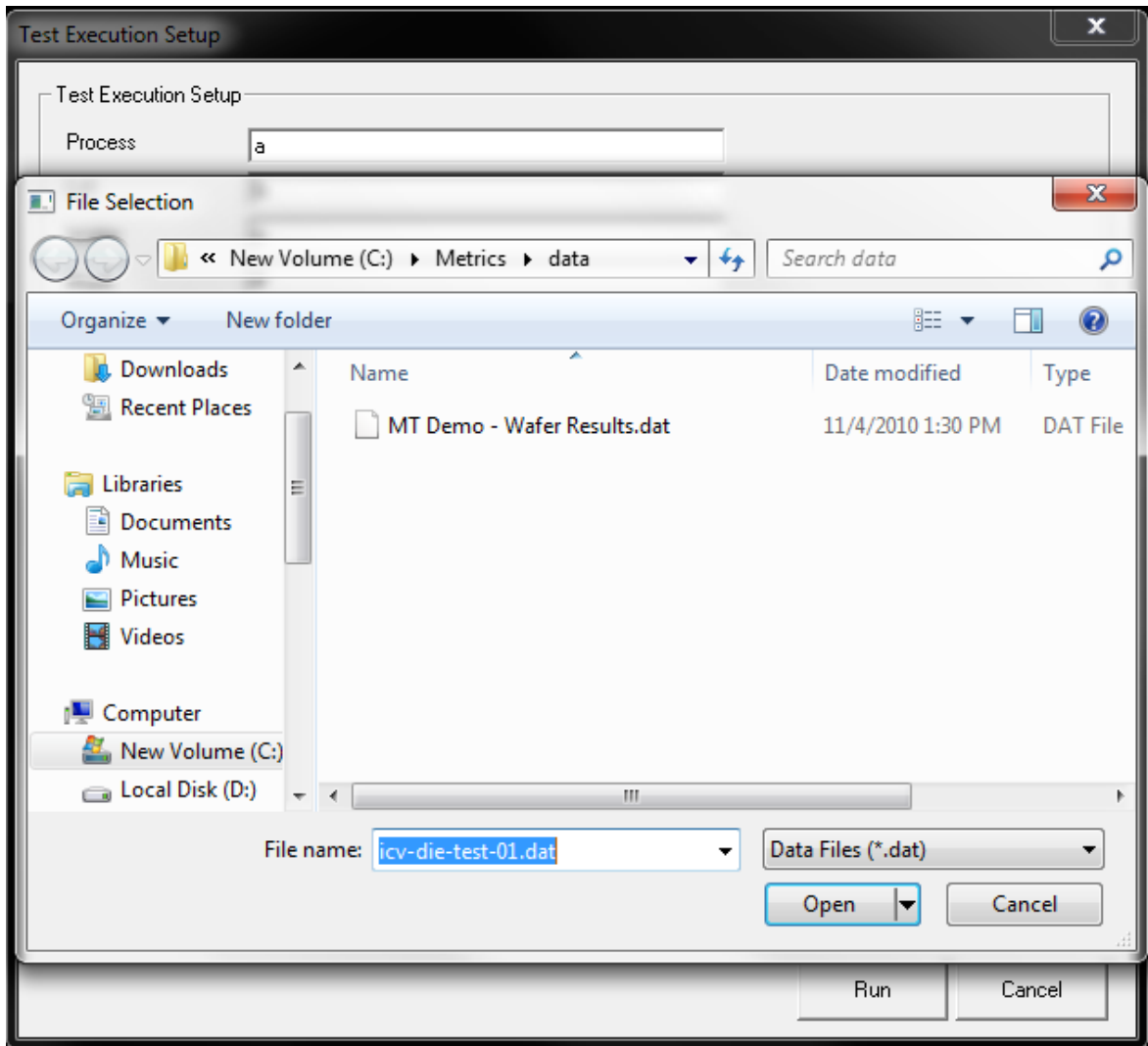

5. Click the **Browse** button next to the Save Results in: field and select the data file to be created.

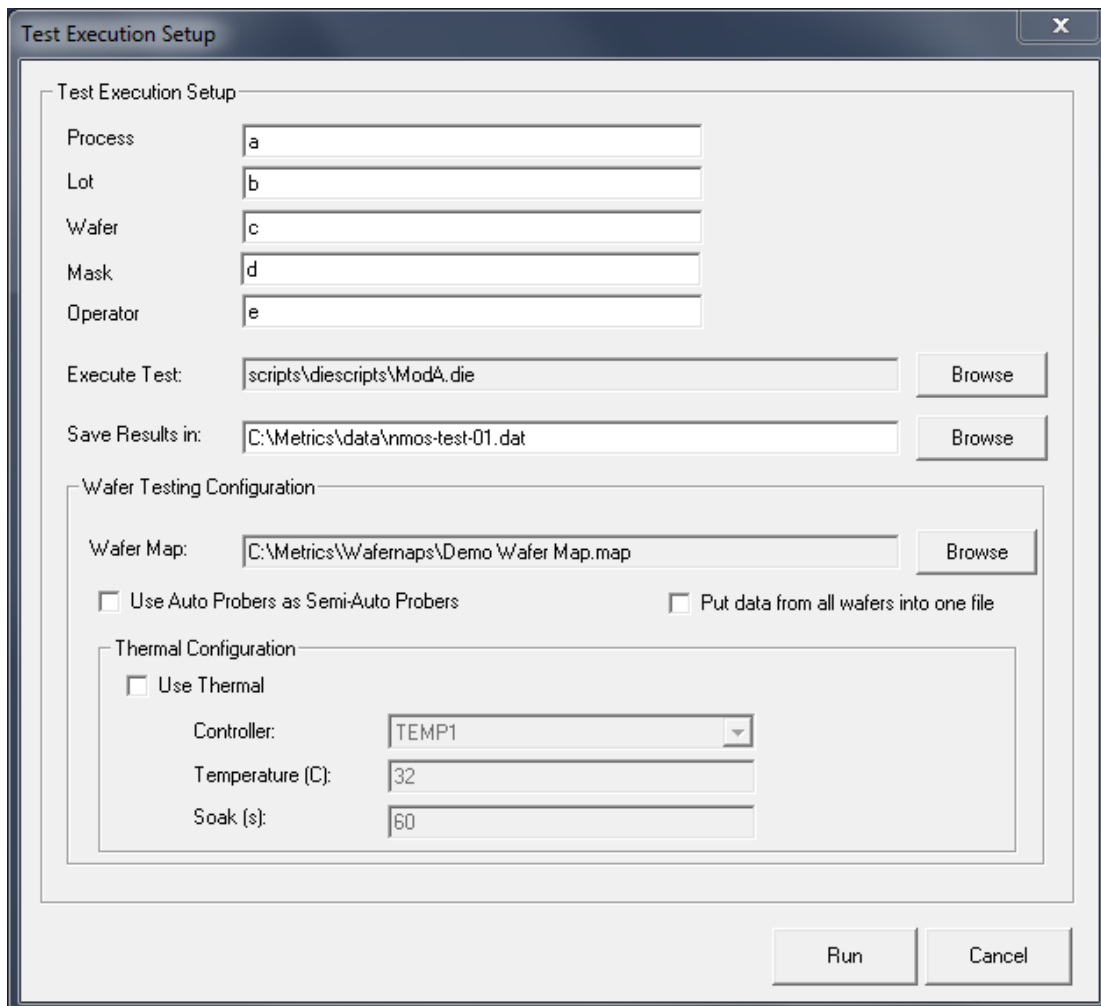

6. Use the Browse button to select the Wafer Map to be run

Note: (if you are doing manual wafer probing select <**No Wafer processing**>). If you are using a fully automatic probe station with only 1 wafer, select the **Use Auto Probers as Semi-Auto Probers** option to prevent the station from unloading the test wafer.

Note: If you are auto-probing you can select the **Put data from all wafers into one file** option to append all the wafer data to on results file. Otherwise the suffix **_Wafer(Slot#)** will be appended to an individual file after each wafer is complete.

7. Click the **Run** button to begin the test.

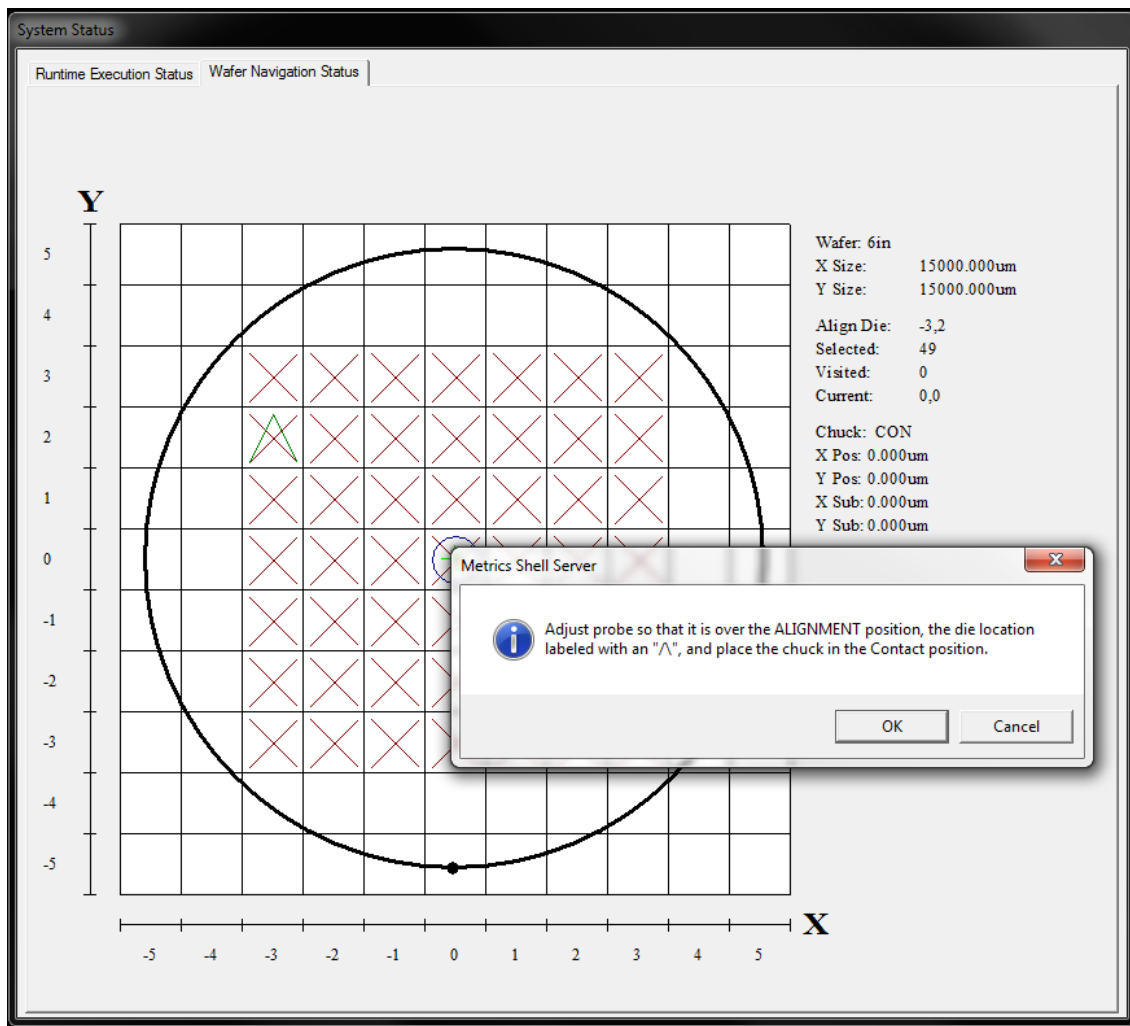

8. If using a wafer map, the Metrics ICV software will prompt the operator to verify the Reference position. Click **OK** to confirm the reference position.

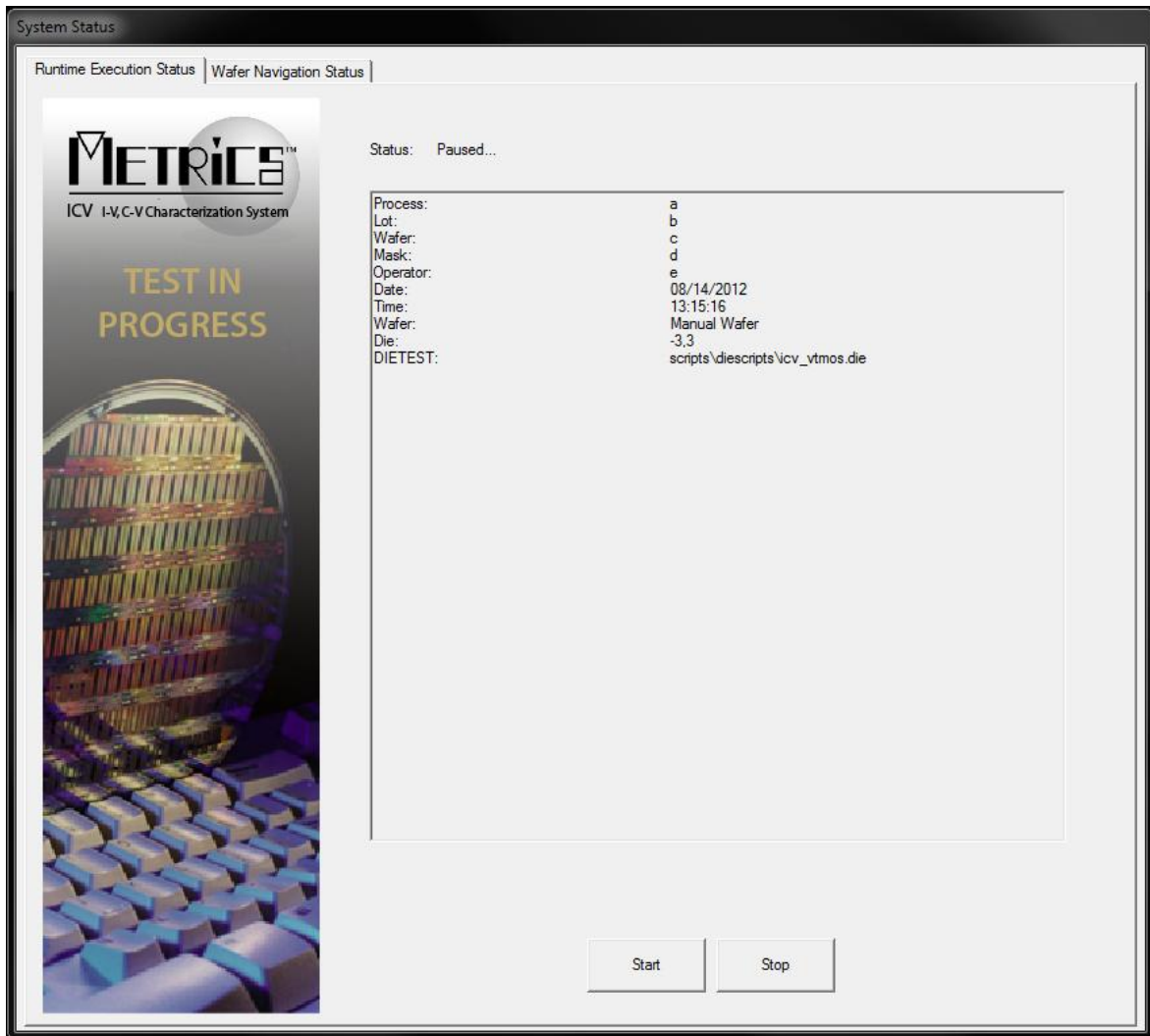

9. The Runtime Status Window will open, click the **Start** button.

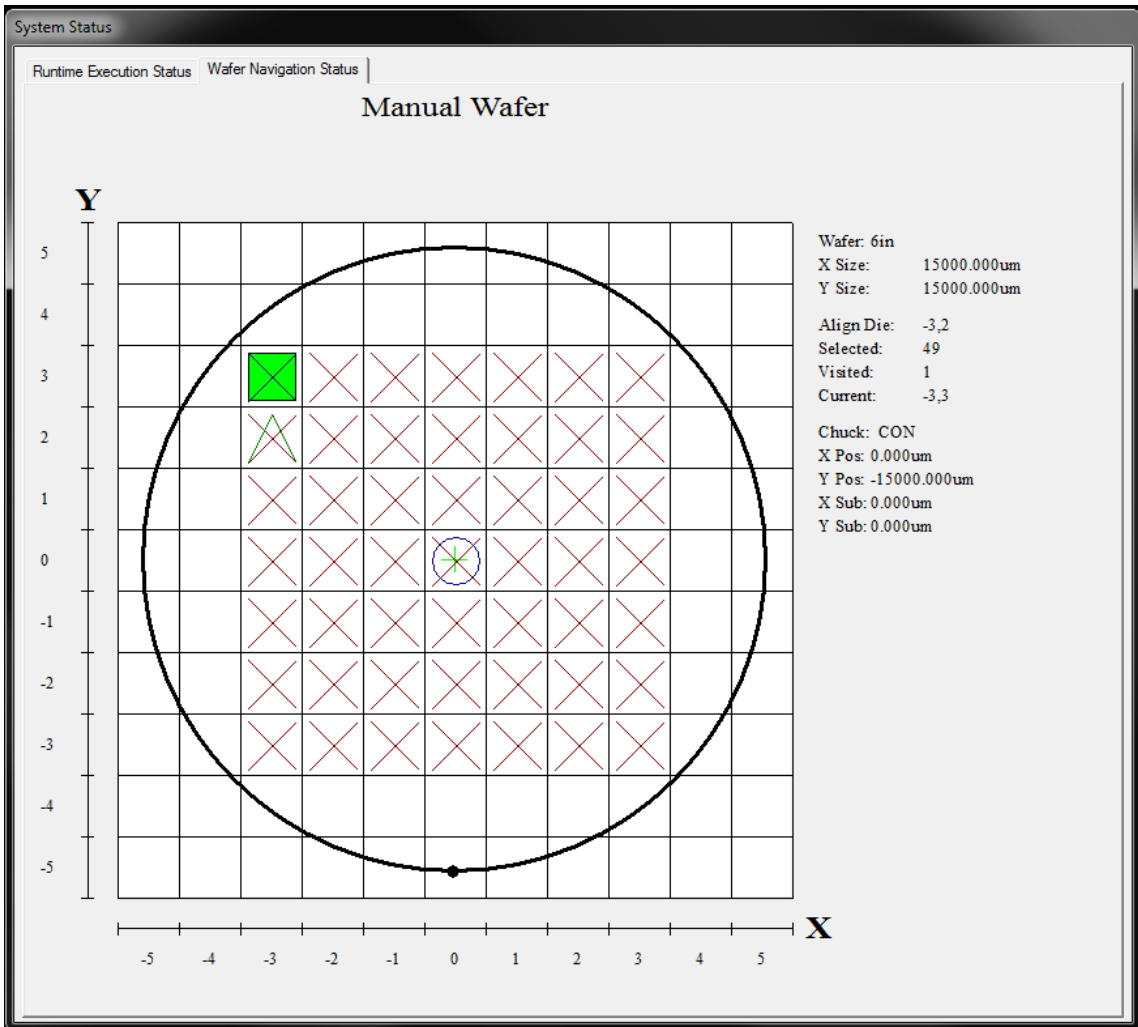

10. While the test is running, the Wafer Navigation Status Window will show the current die that is being tested.

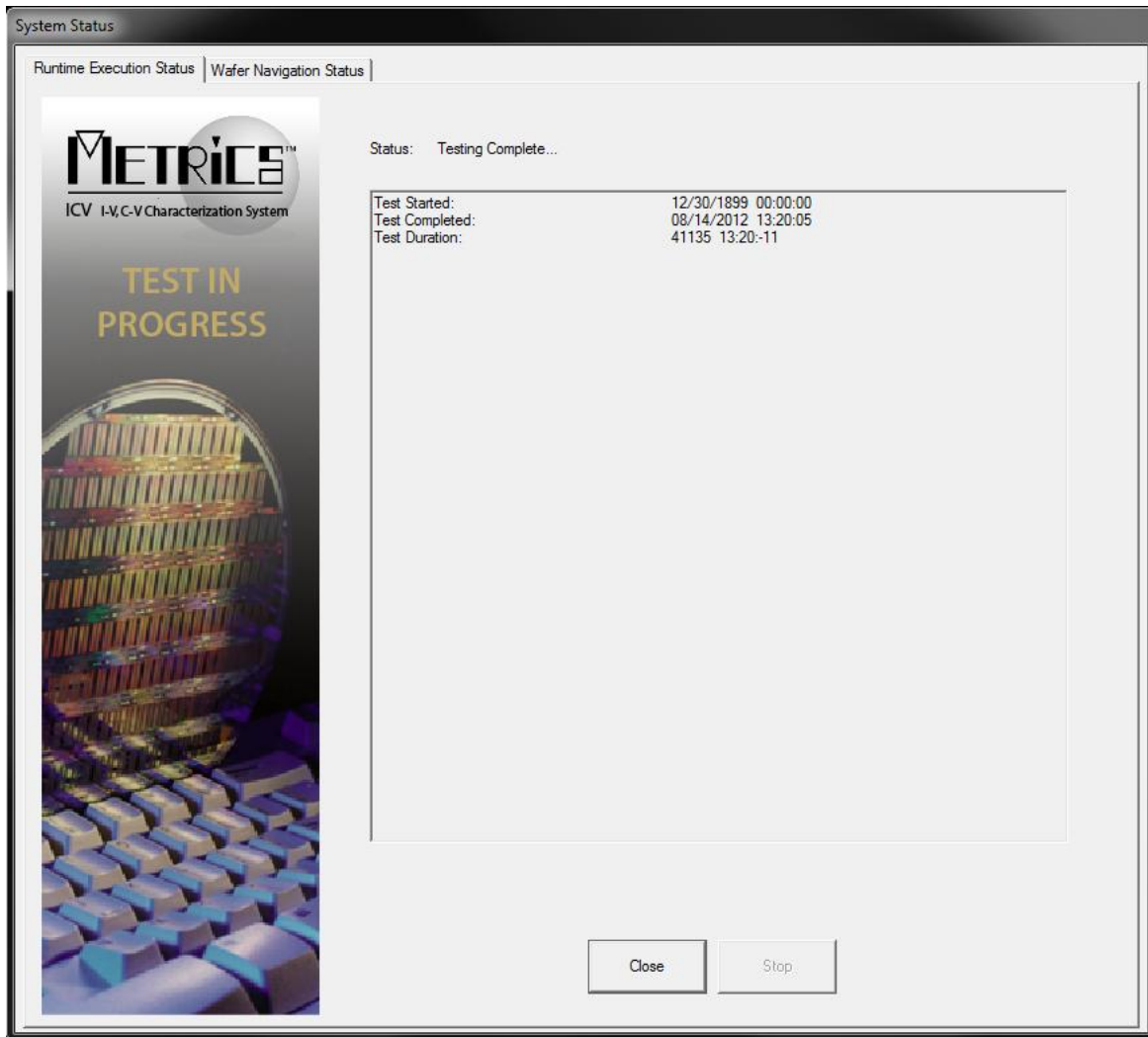

11. At the end of the test the Runtime Status Window will provide a Test Complete status message.
12. Click the **Close** button to end the current test

Chapter 10- Data Manipulation

Introduction

This chapter covers the data that was collected in the previous chapter and what can be done to it using tools built into Metrics ICV.

Topics Covered

- Where is the data?
- Creating a wafer map
- Exporting data
- Viewing data curves

Where is the Data?

The data created by the execution of the Metrics ICV software is saved in the file specified by the operator when starting the test.

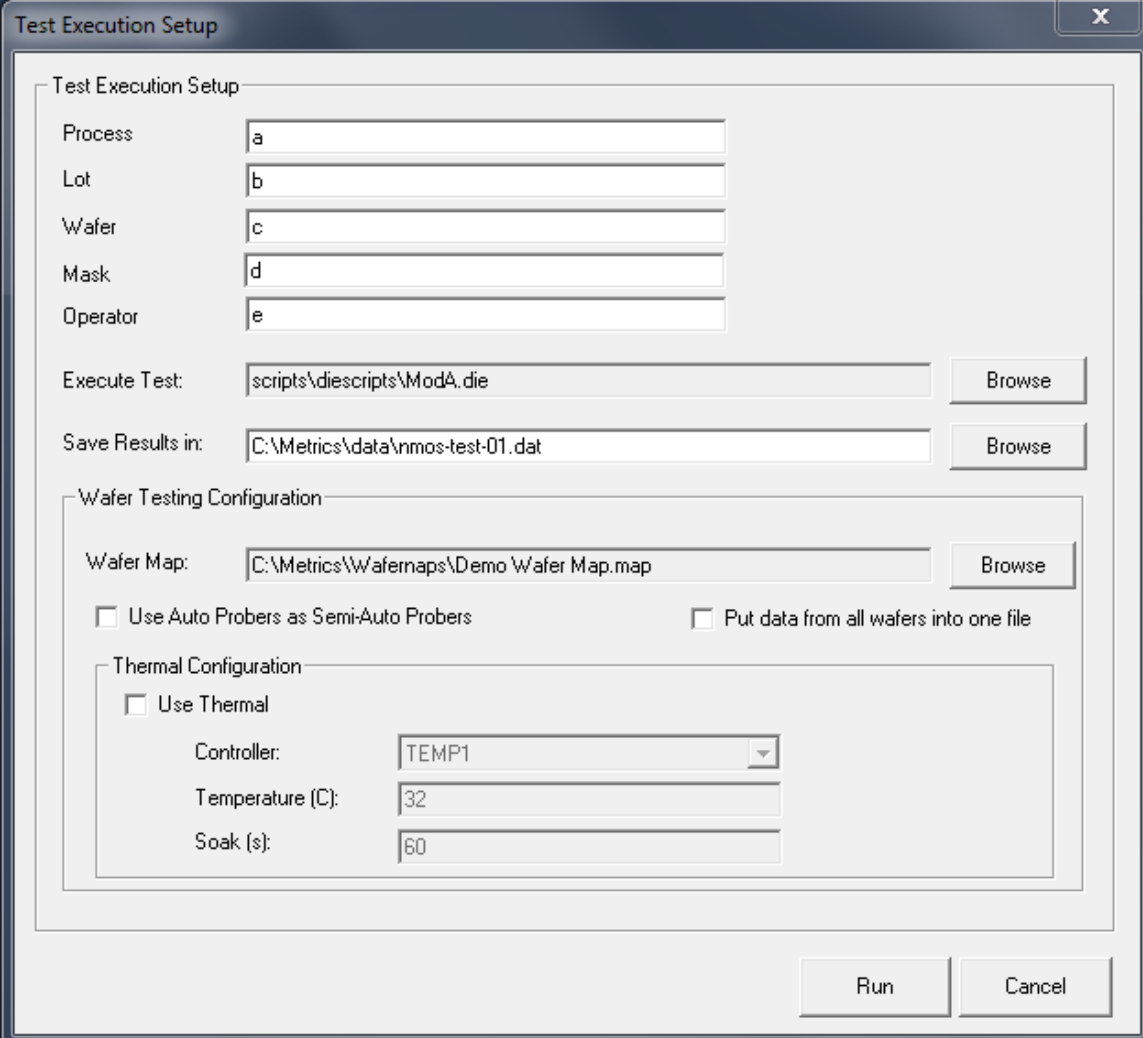

The screenshot shows the 'Test Execution Setup' dialog box. It contains several sections for configuring a test run:

- Test Execution Setup:** Fields for Process (a), Lot (b), Wafer (c), Mask (d), and Operator (e).
- Execute Test:** Field containing 'scripts\diescripts\ModA.die' with a 'Browse' button.
- Save Results in:** Field containing 'C:\Metrics\data\nmos-test-01.dat' with a 'Browse' button.
- Wafer Testing Configuration:**
 - Field for Wafer Map: 'C:\Metrics\Wafers\Demo\Wafer Map.map' with a 'Browse' button.
 - Checkboxes: 'Use Auto Probers as Semi-Auto Probers' (unchecked) and 'Put data from all wafers into one file' (unchecked).
- Thermal Configuration:**
 - Checkbox: 'Use Thermal' (unchecked).
 - Controller: Dropdown menu set to 'TEMP1'.
 - Temperature (C): Text field containing '32'.
 - Soak (s): Text field containing '60'.

At the bottom right, there are 'Run' and 'Cancel' buttons.

The data is saved in tab-delimited ASCII format.

In addition the file contains tags to identify the various levels of data. This representation is reasonable to read, but is very desirable for writing post-processing macros.

```

results.dat - Notepad
File Edit Search Help
<BEG GLOBAL>
  process[s]      new Implanter
  lot[s] 11111
  wafer[s]       23
  package[s]     none
  operator[s]    Ina Tech
  Date[s] 08/24/1999
  Time[s] 19:20:1
<END GLOBAL>
<BEG> SCRIPT (scripts\hpSamplescr.scr)
  <BEG> Algorithm (UT)
    <BEG PARMS>
      UG-PTS[c]      34
      UD-VALUE[c]   0.1
      UG-START[c]   0
      UG-STOP[c]    3.3
      UG-STEP[c]    0.1
      UG-COMPL[c]   0.1
      US-VALUE[c]   0
      UB-VALUE[c]   0
      UT            1.19496
      IDOFF         1.55e-013
      IDON          0.0012928
      GHNAX         0.00110054
    <END PARMS>
    <BEG DATA>
      ID      UG
      1.55e-013      0
      3.16e-013      0.1
      9.51e-013      0.2
      3.757e-012     0.3
      1.6979e-011    0.4
      8.2546e-011    0.5
      4.3478e-010    0.6
      2.3693e-009    0.7
      1.3728e-008    0.8
      7.958e-008     0.9
      4.5307e-007     1
      2.3015e-006     1.1
      1.02365e-005    1.2
  </BEG>
</BEG>

```

Creating a Wafer Map

Metrics ICV contains a tool named the Metrics Miner. The Metrics Miner application is very useful for the viewing of Wafer Maps and manipulation of data.

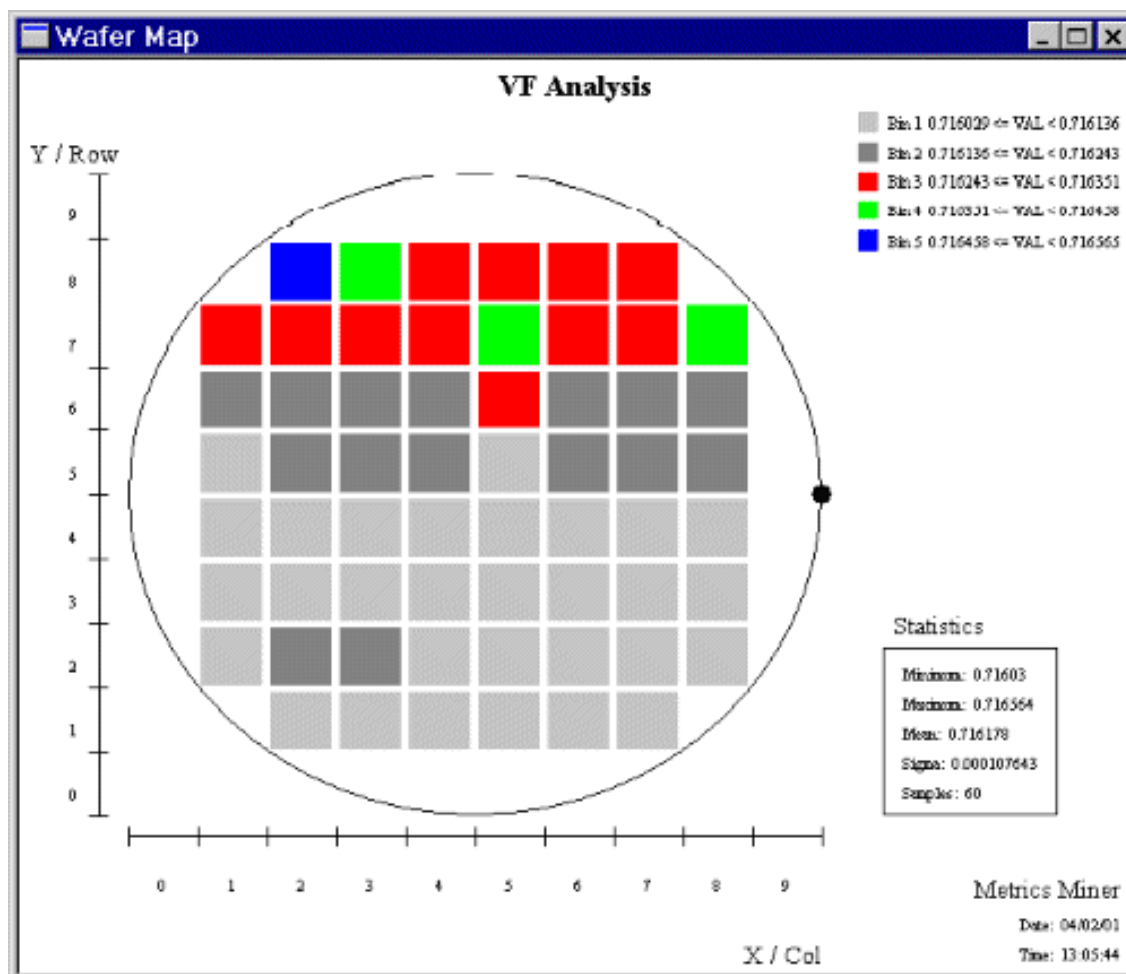

This first example will detail how to create a wafer map using Metrics Miner.

The steps to create a probe plan are:

A. Start Metrics Miner

The Metrics Miner can be started from the Metrics ICV toolbar by clicking the **Analysis >> Miner** menu item or the **Stats** button under the Analysis area of the Metrics ICV navigation window.

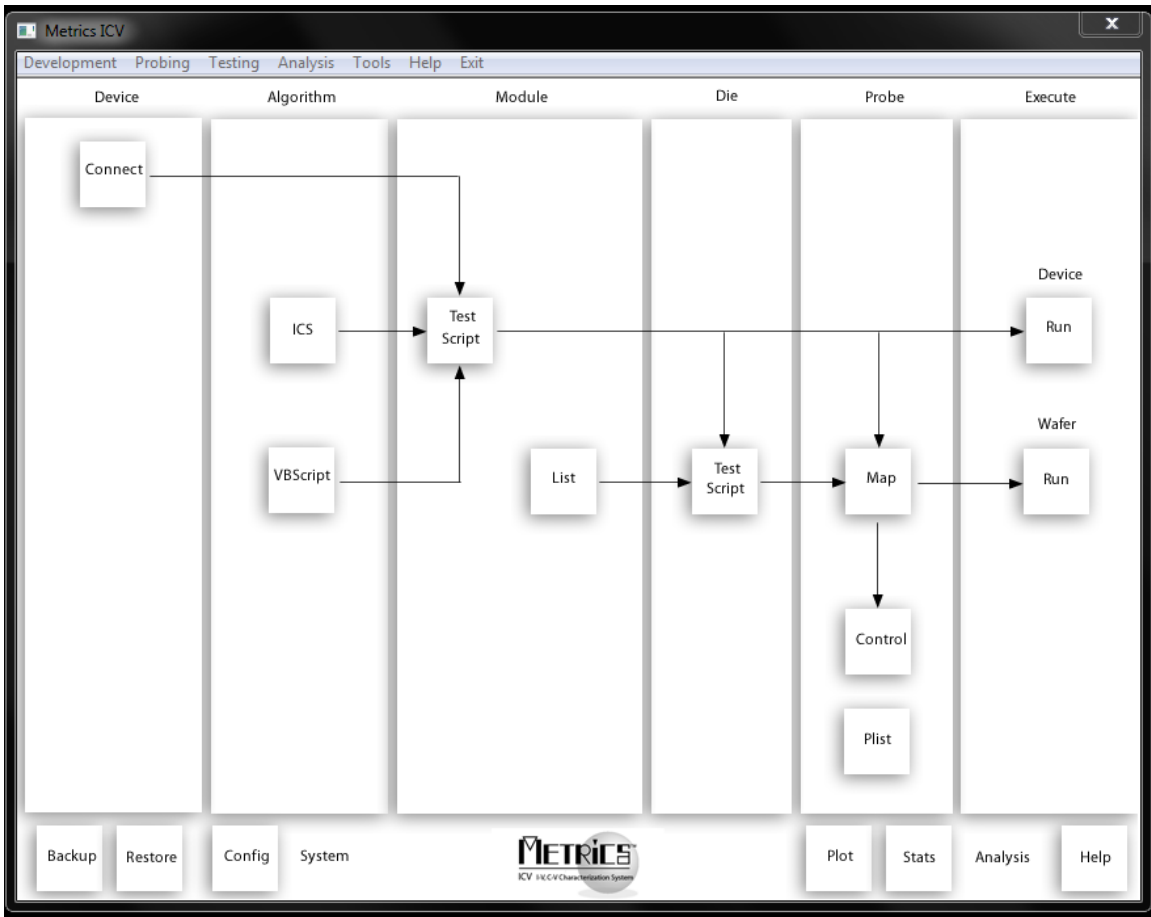

B. Load Data

The first step to manipulating the data with Metrics Miner is to load the data from the saved data file.

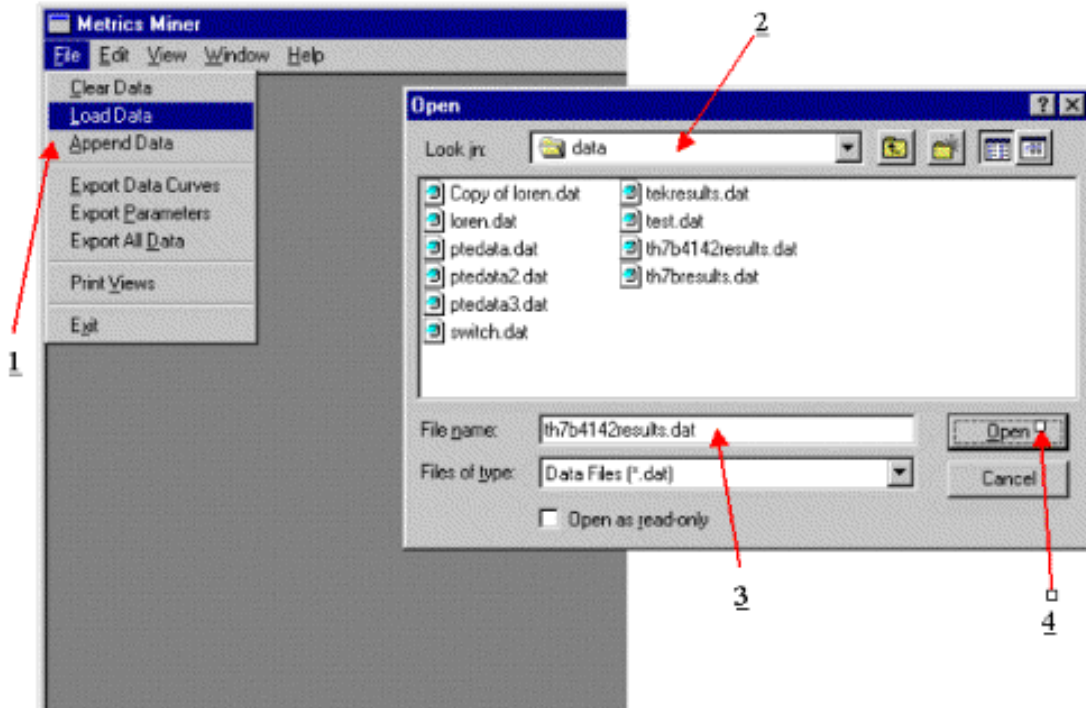

1. Click the **File | Load Data** menu item.
2. Select the directory containing the data file.
3. Select the data file.
4. Click the **Open** button.

C. Select Parameter to Map

Once the data has been loaded, subsequent wafer maps or data exports can be created without reloading the data.

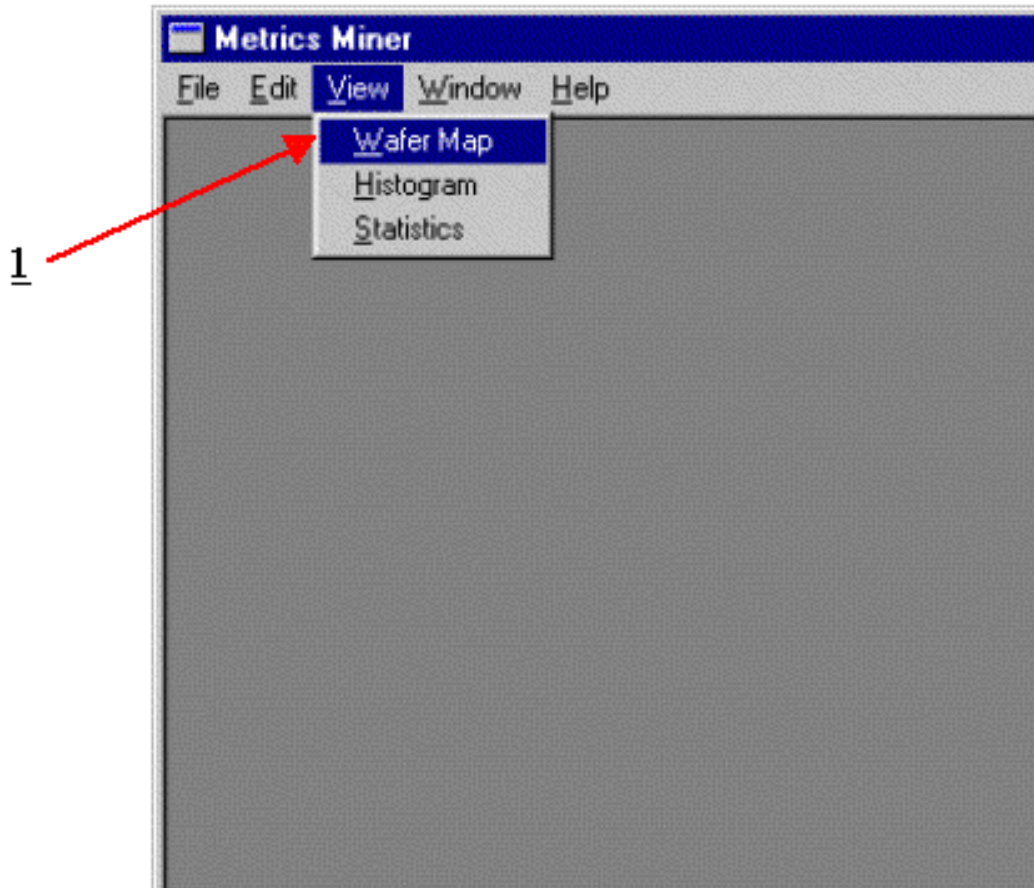

I. Click the **View | Wafer Map** menu item.

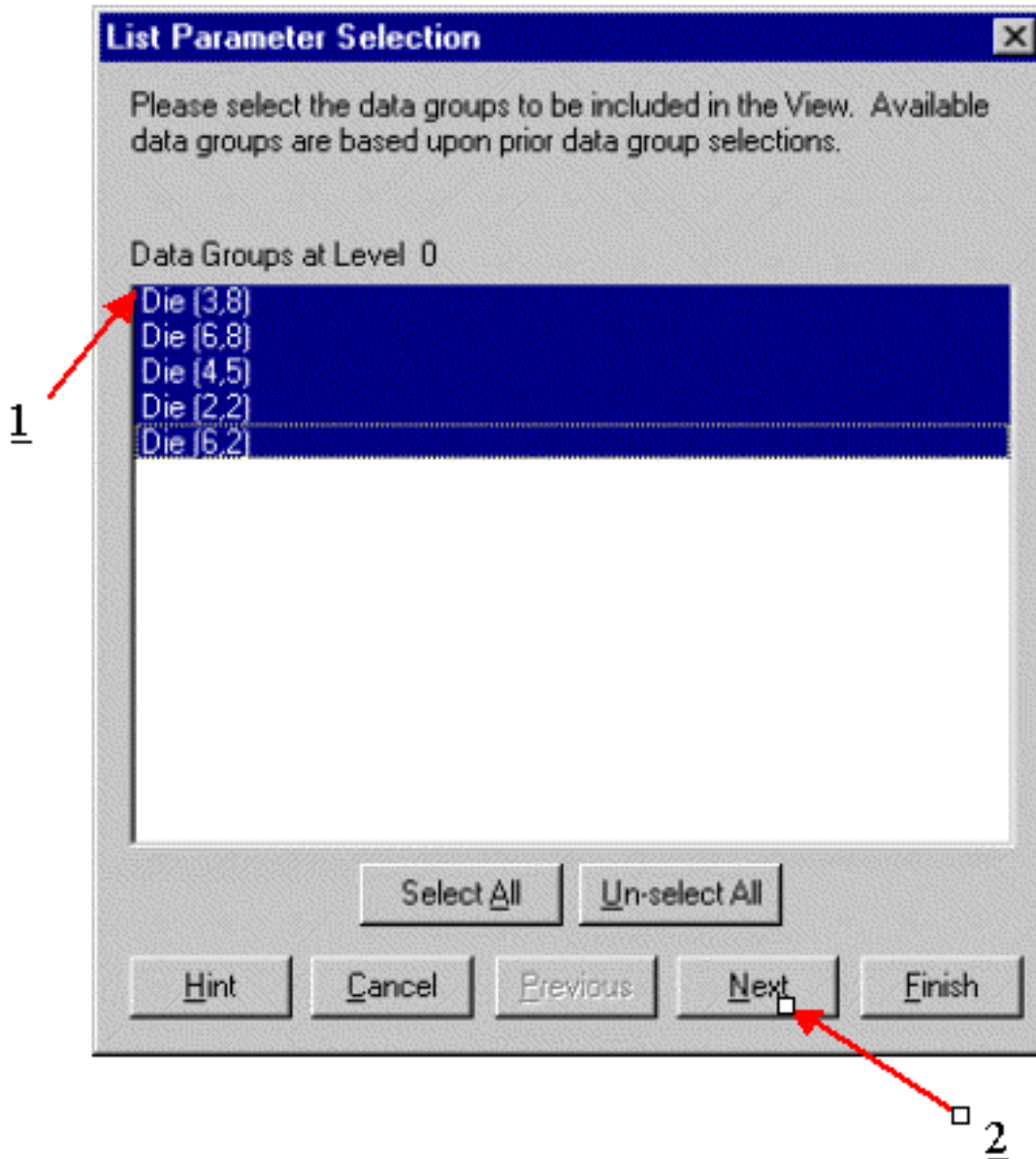

II. Select the die locations to map:

1. Select the **Die** locations
2. Click the **Next** button.

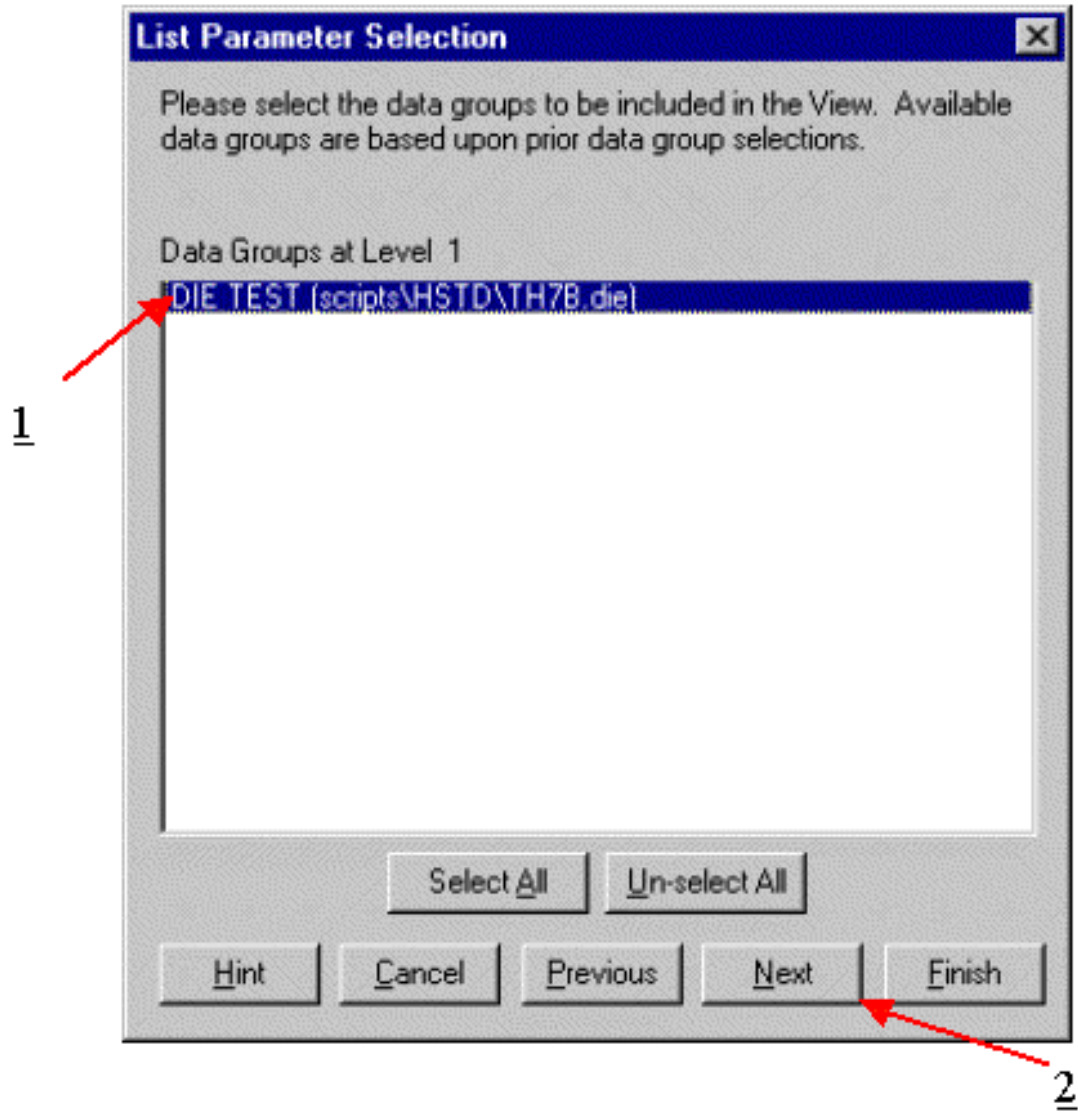

III. Select the die script that contains the parameter to map:

1. Select the **Die** script
2. Click the **Next** button.

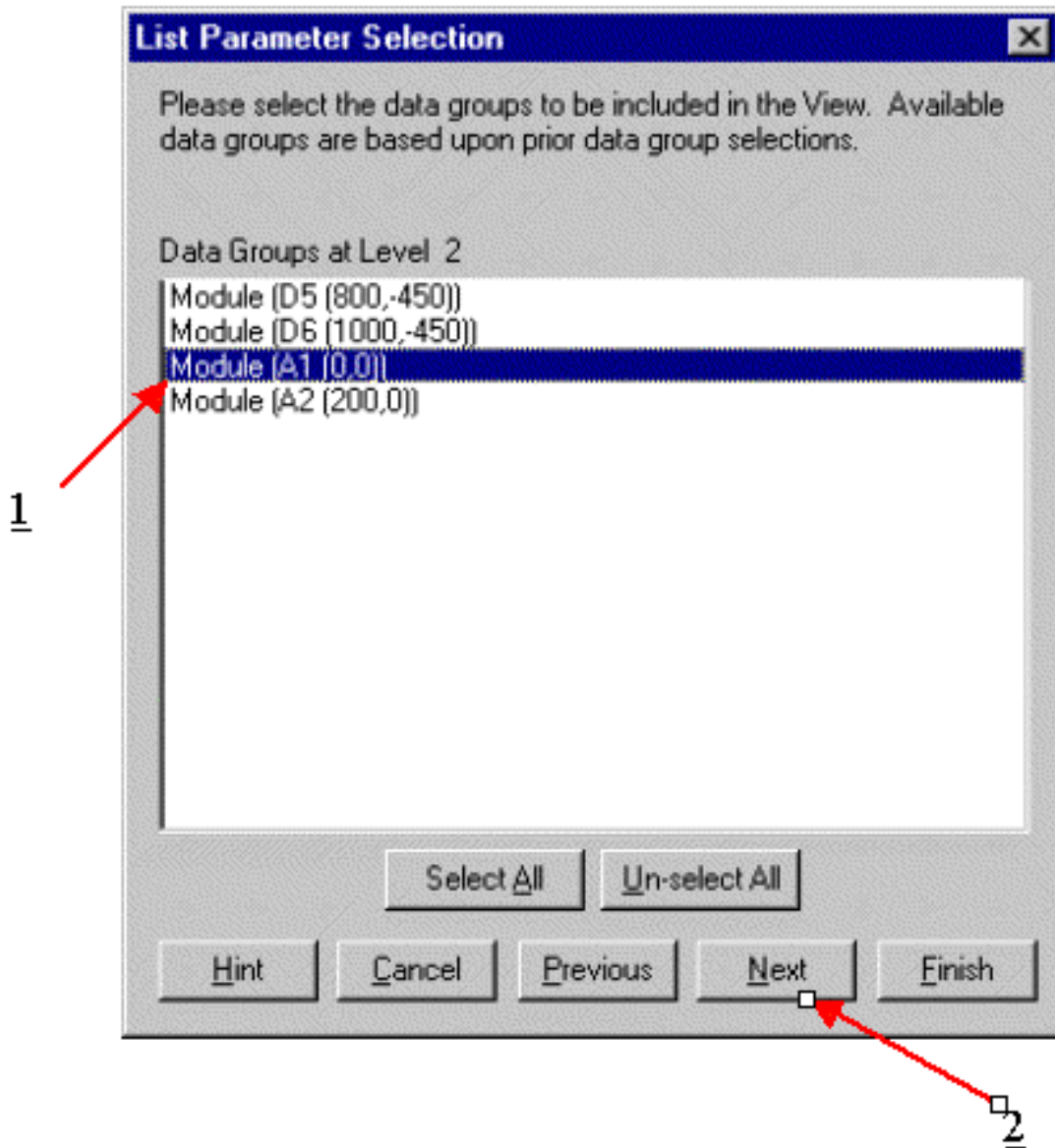

IV. Select the module that contains the parameter to map:

1. Select the **Module**
2. Click the **Next** button.

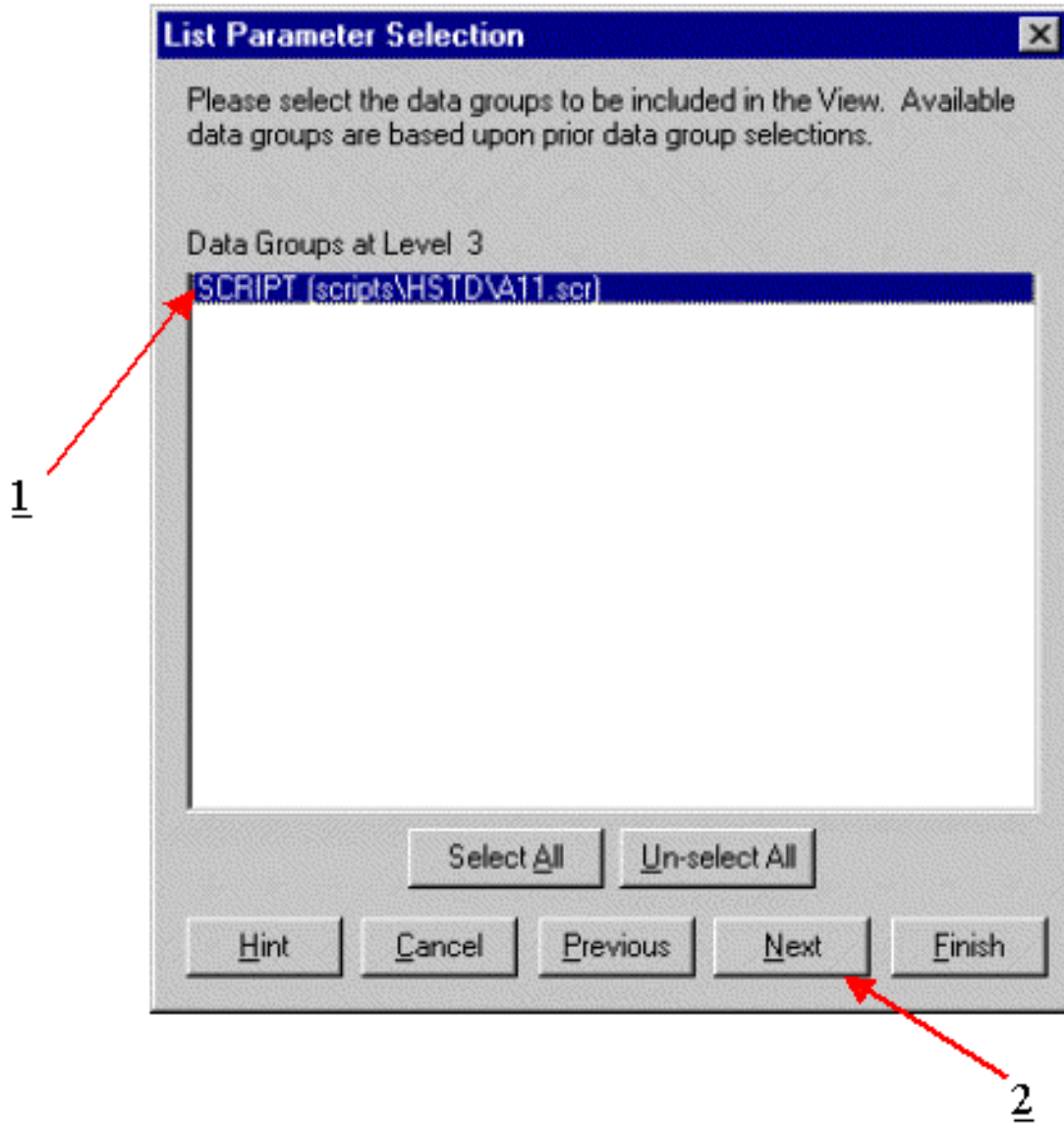

V. Select the module script that contains the parameter to map:

1. Select the **Module** script
2. Click the **Next** button.

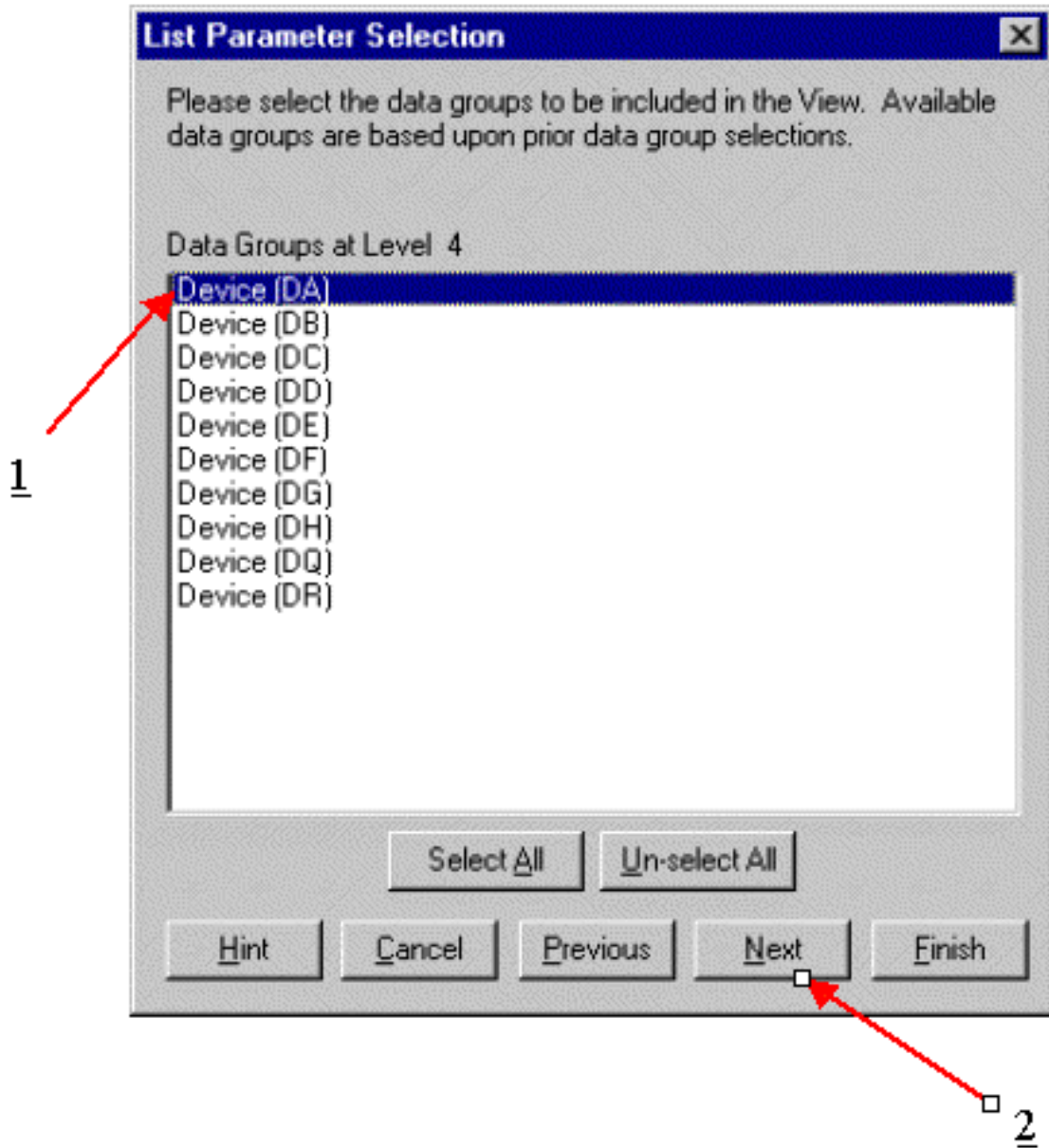

VI. Select the device whose parameter is to be mapped:

1. Select the **Device**
2. Click the **Next** button.

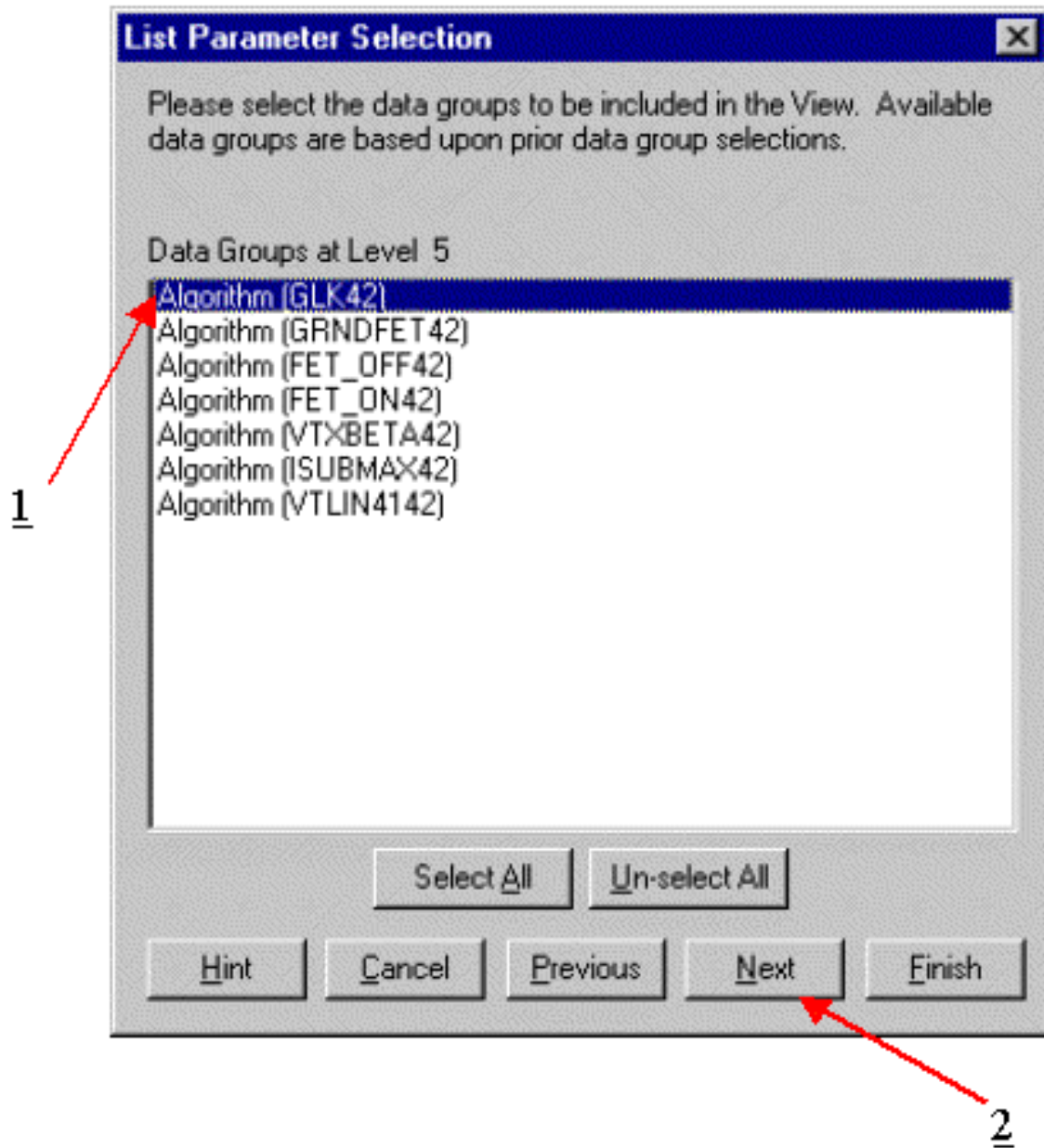

VII. Select the test algorithm that contains the parameter to map:

1. Select the test **Algorithm**
2. Click the **Next** button.

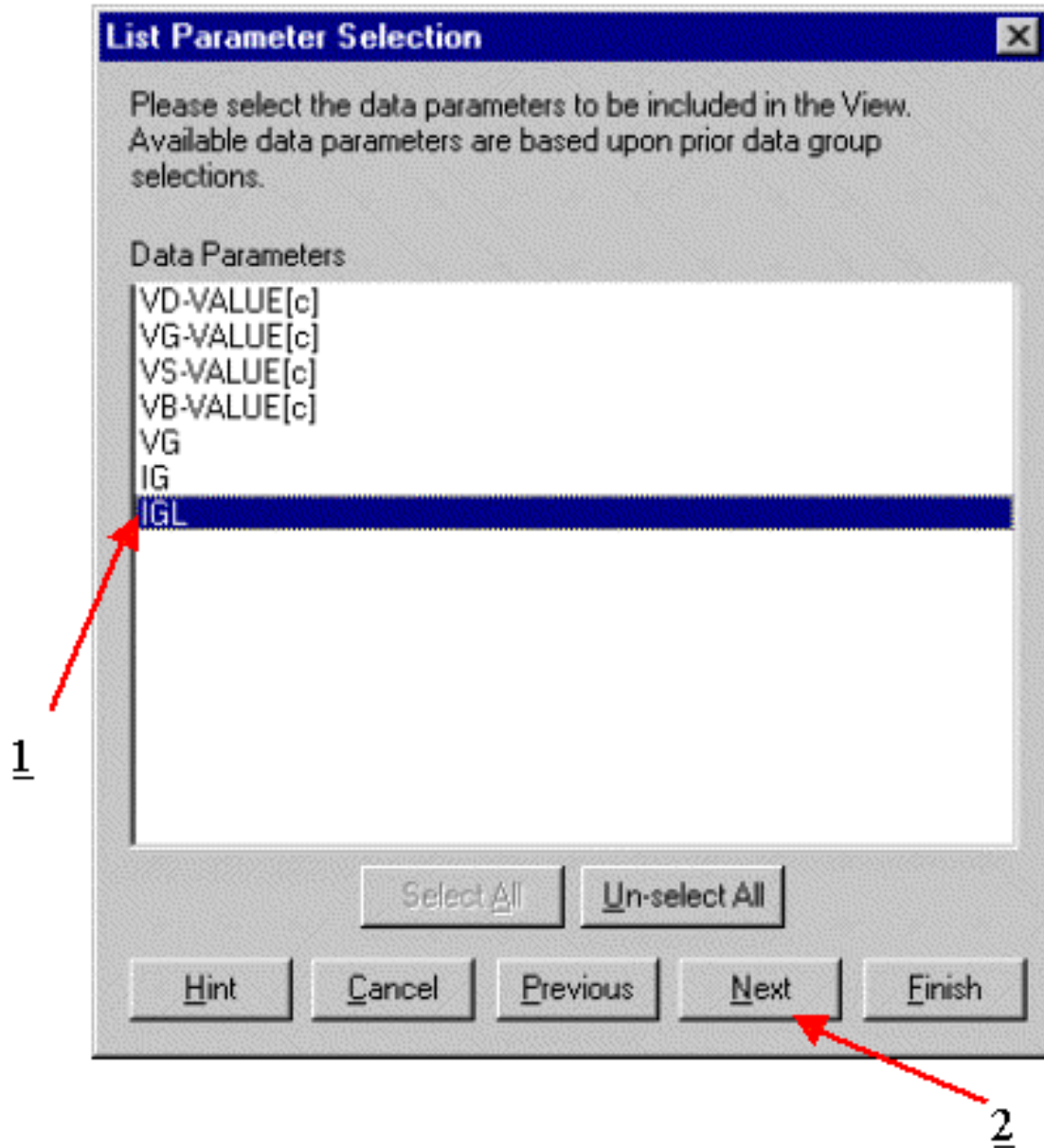

VIII. Select the parameter to map:

1. Select the **Parameter**
2. Click the **Next** button.

D. Setup Map Title and Notes

The wafer map can be given a Title and Notes.

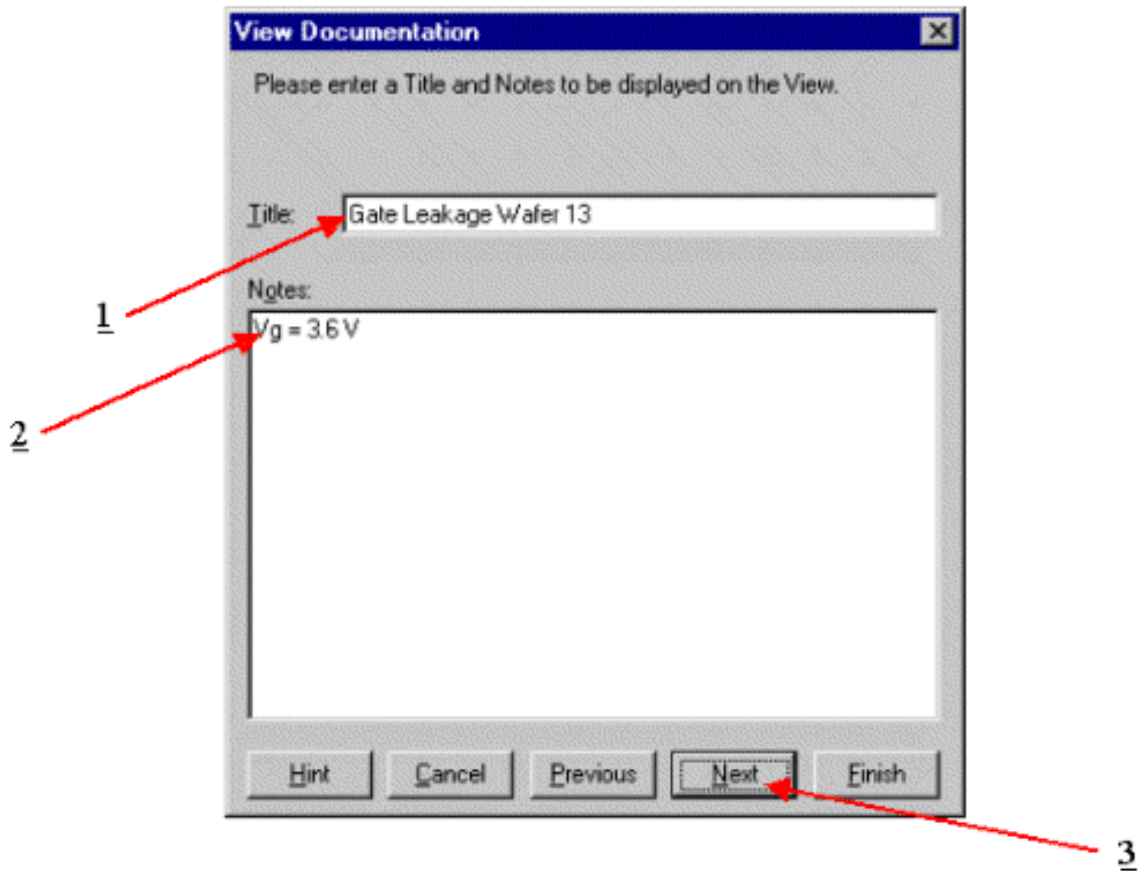

1. Enter a **Title** for the wafer map.
2. Enter **Notes** for the wafer map.
3. Click the **Next** button.

E. Setup Bins

The binning must be set for the wafer map. The values can be binned automatically or the user can specify upper and lower bounds along with the number of bins.

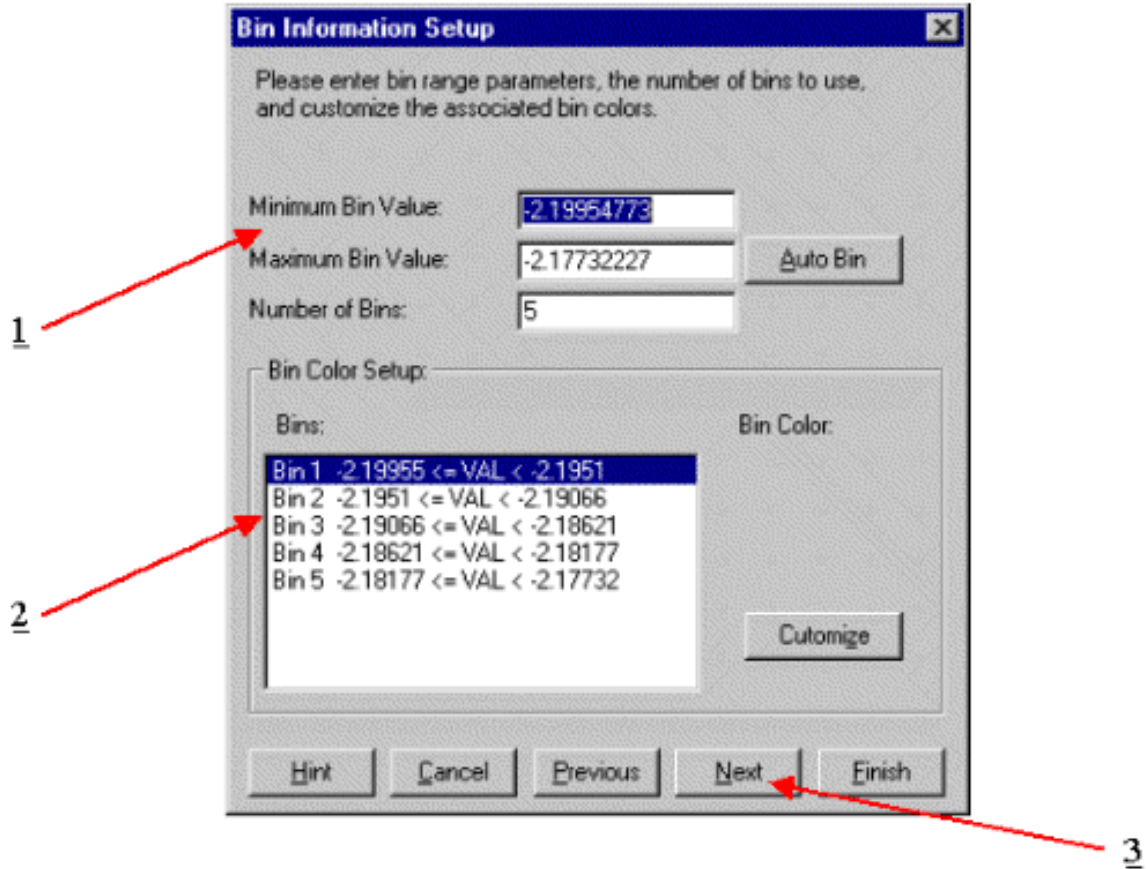

1. Enter the **Bin** parameters.
2. Edit the bin **Colors**.
3. Click the **Next** button.

F. Results

The resulting wafer map is shown below. This plan can be copied to the clipboard and pasted into other programs. In addition the plan can be printed directly to a printer.

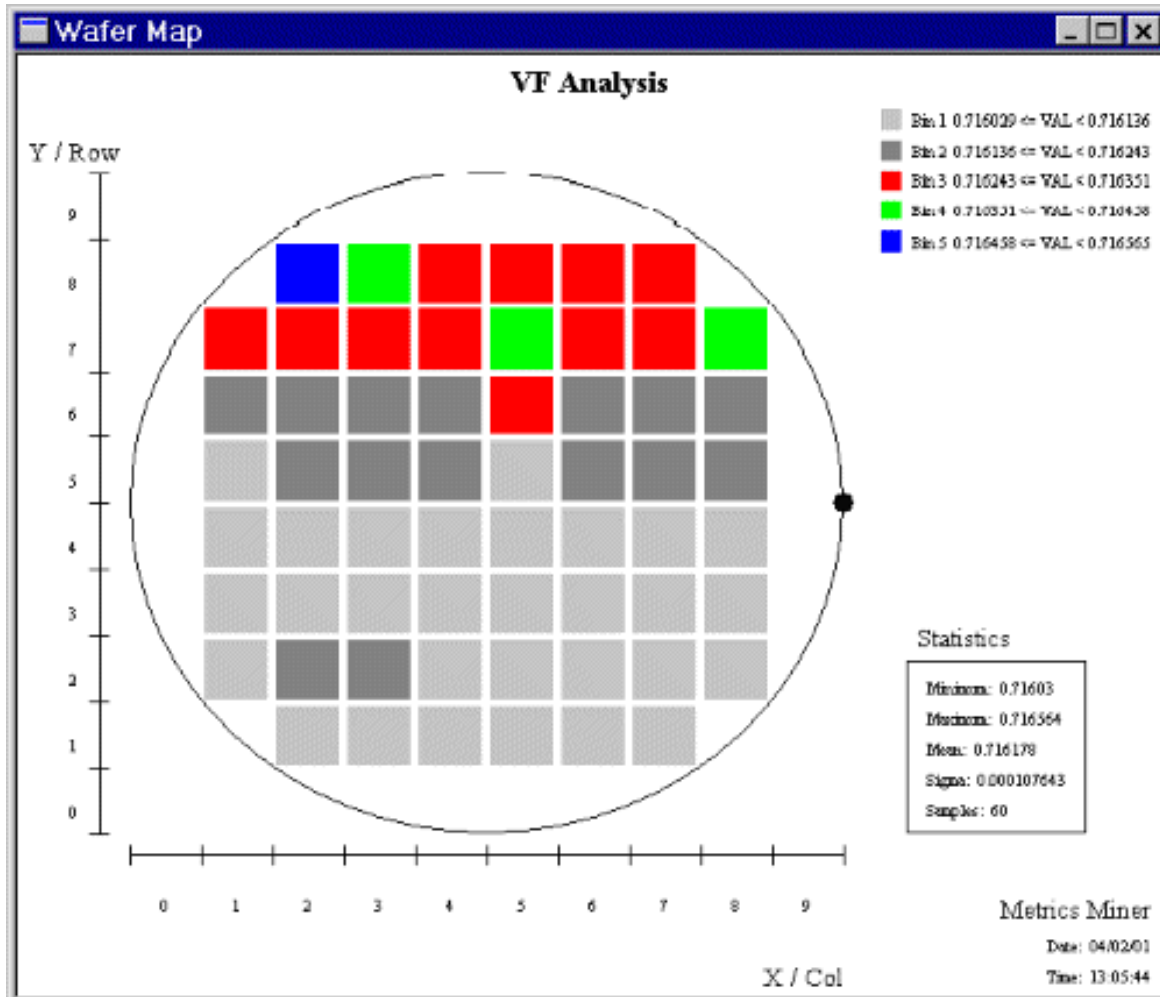

Exporting Data

The Metrics Miner application is very useful for the viewing of wafer maps and manipulation of data.

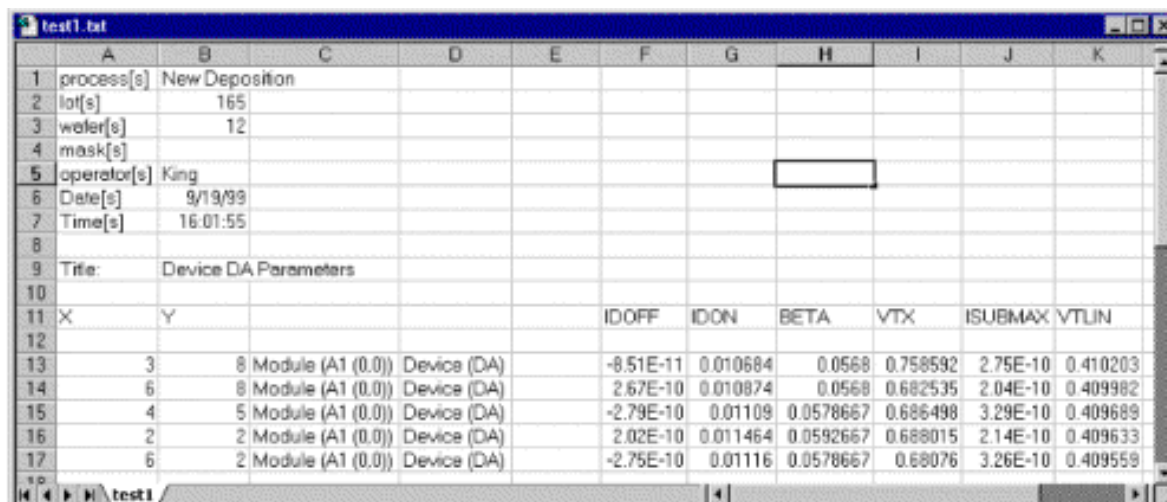

The screenshot shows a spreadsheet window titled 'test1.bat'. The data is organized into several sections. The first section (rows 1-7) contains process parameters: process[s] (New Deposition), lot[s] (165), wafer[s] (12), mask[s], operator[s] (King), Date[s] (9/19/99), and Time[s] (16:01:55). The second section (row 9) has a title 'Device DA Parameters'. The third section (rows 11-17) is a table with columns X, Y, IDOFF, IDON, BETA, VTX, ISUBMAX, and VTLIN. The data rows (13-17) show values for these parameters across different modules and devices.

	A	B	C	D	E	F	G	H	I	J	K
1	process[s]	New Deposition									
2	lot[s]	165									
3	wafer[s]	12									
4	mask[s]										
5	operator[s]	King									
6	Date[s]	9/19/99									
7	Time[s]	16:01:55									
8											
9	Title:	Device DA Parameters									
10											
11	X	Y				IDOFF	IDON	BETA	VTX	ISUBMAX	VTLIN
12											
13		3	8 Module (A1 (0.0))	Device (DA)		-8.51E-11	0.010684	0.0568	0.758592	2.75E-10	0.410203
14		6	8 Module (A1 (0.0))	Device (DA)		2.67E-10	0.010874	0.0568	0.682535	2.04E-10	0.409982
15		4	5 Module (A1 (0.0))	Device (DA)		-2.79E-10	0.01109	0.0578667	0.686498	3.29E-10	0.409689
16		2	2 Module (A1 (0.0))	Device (DA)		2.02E-10	0.011464	0.0592667	0.688015	2.14E-10	0.409633
17		6	2 Module (A1 (0.0))	Device (DA)		-2.75E-10	0.01116	0.0578667	0.68076	3.26E-10	0.409559

This example will detail how to export data parameters using Metrics Miner

The steps to export data are:

A. Start Metrics Miner

The Metrics Miner can be started from **Analysis >> Miner** menu item or the **Stats** button in the Analysis area of the Metrics ICV navigation window.

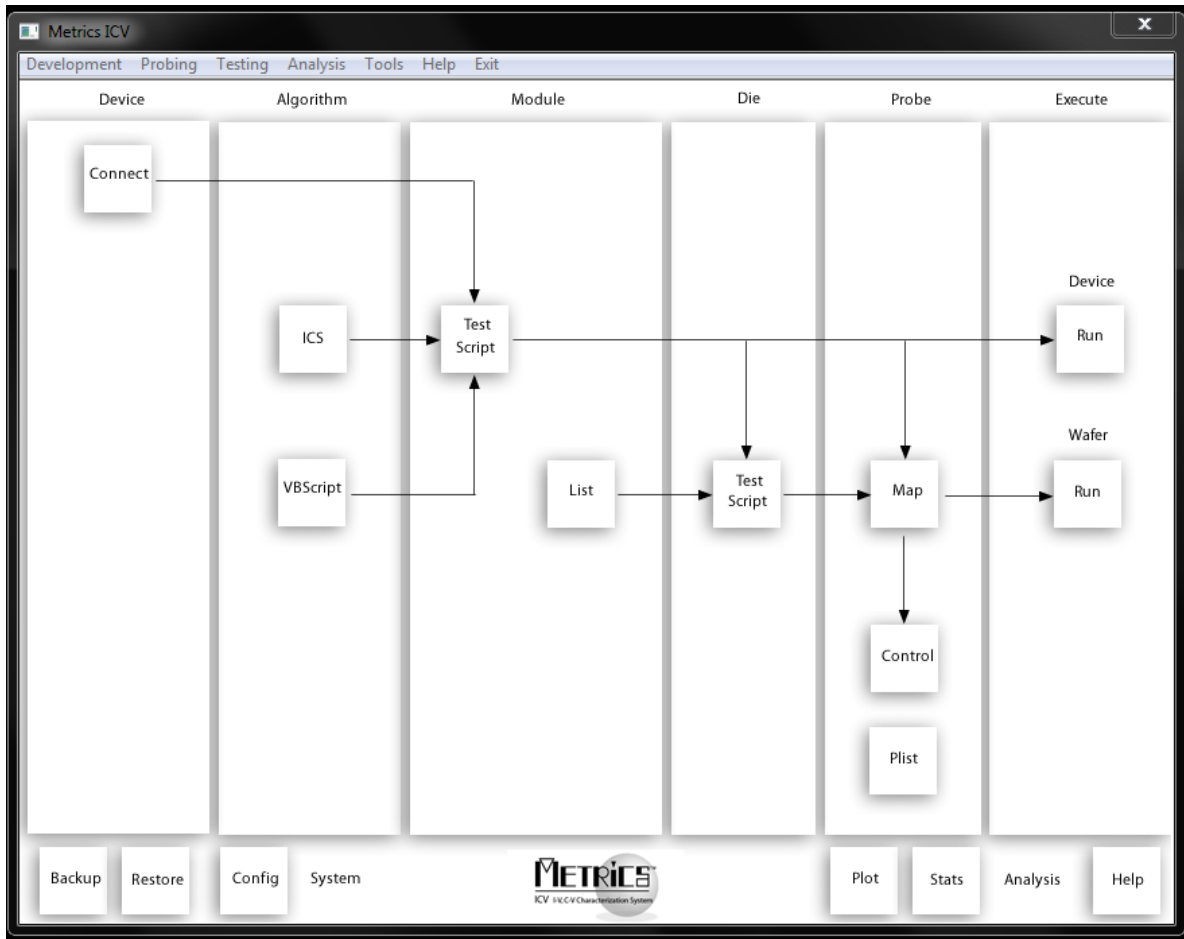

B. Load Data

The first step to manipulating the data with Metrics Miner is to load the data from the saved data file.

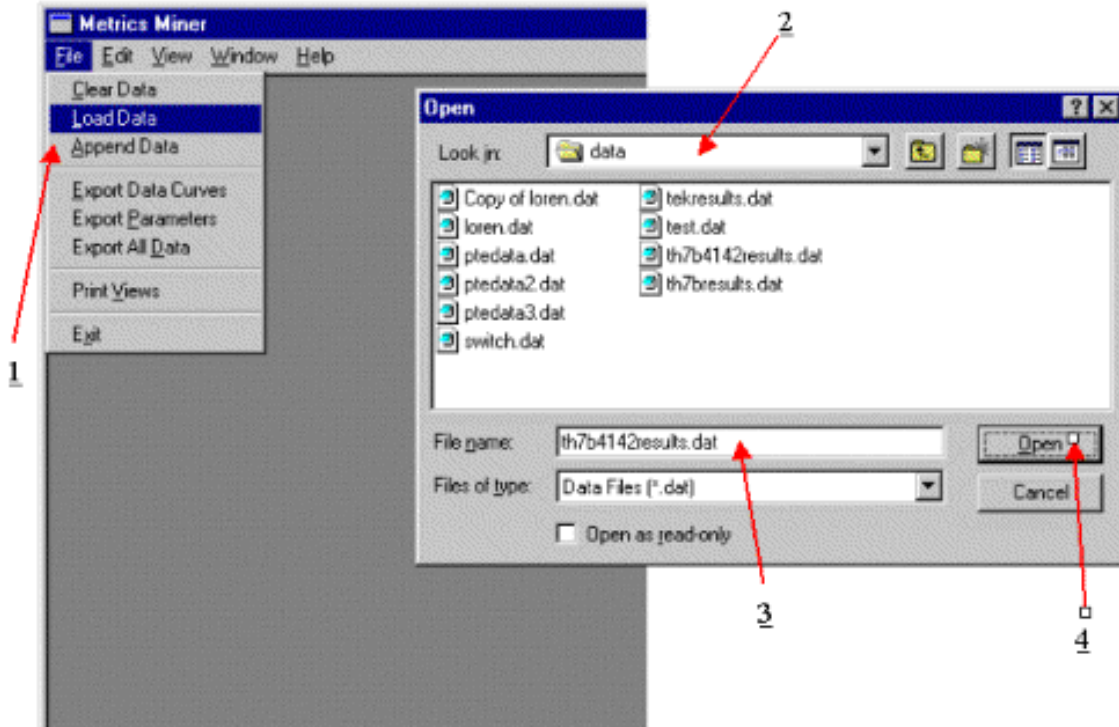

1. Click the **File | Load Data** menu item.
2. Select the directory containing the data file.
3. Select the data file.
4. Click the **Open** button.

C. Select Parameter(s) to Export

Once the data has been loaded, subsequent wafer maps or data exports can be created without reloading the data.

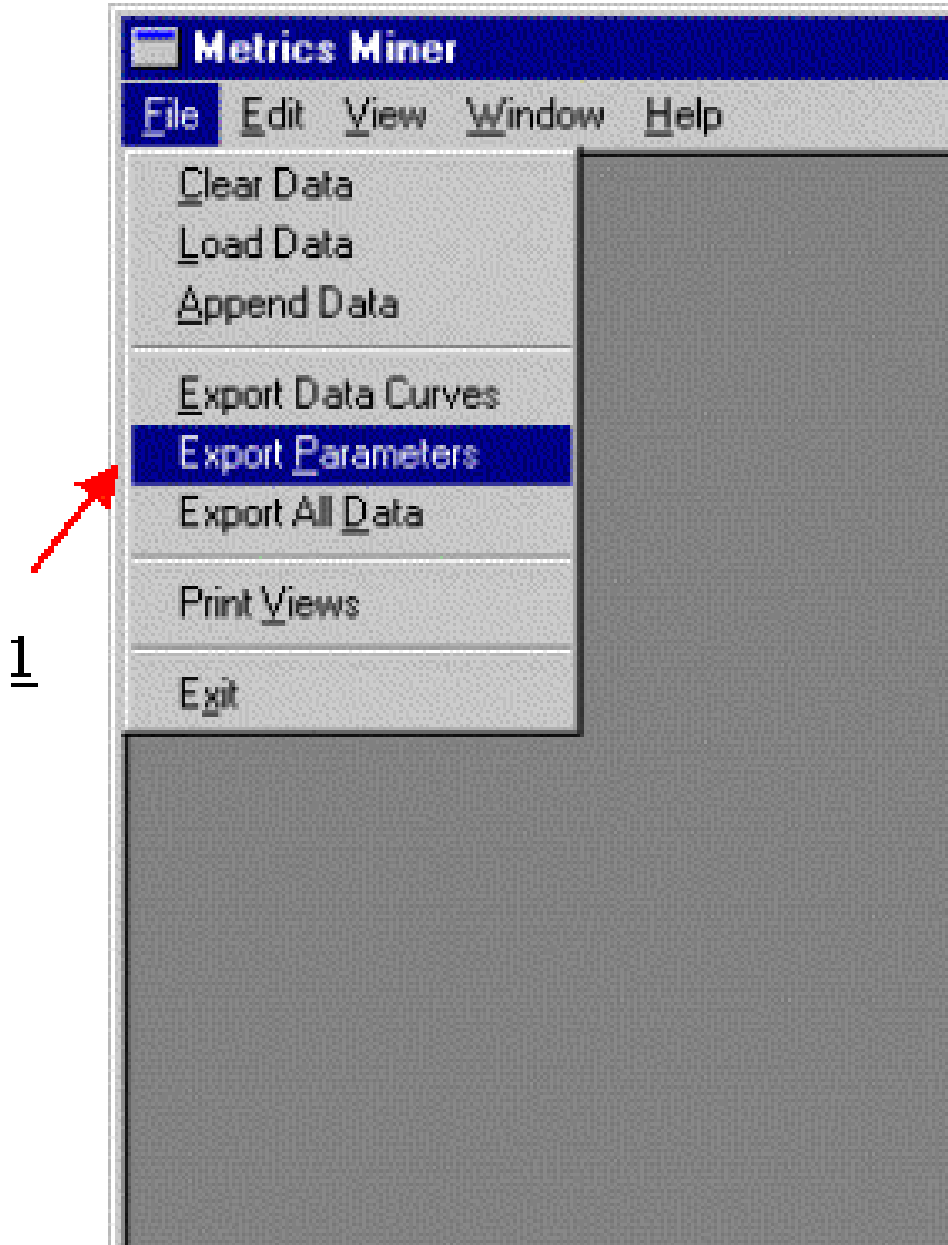

I. Click the **File | Export Parameters** menu item.

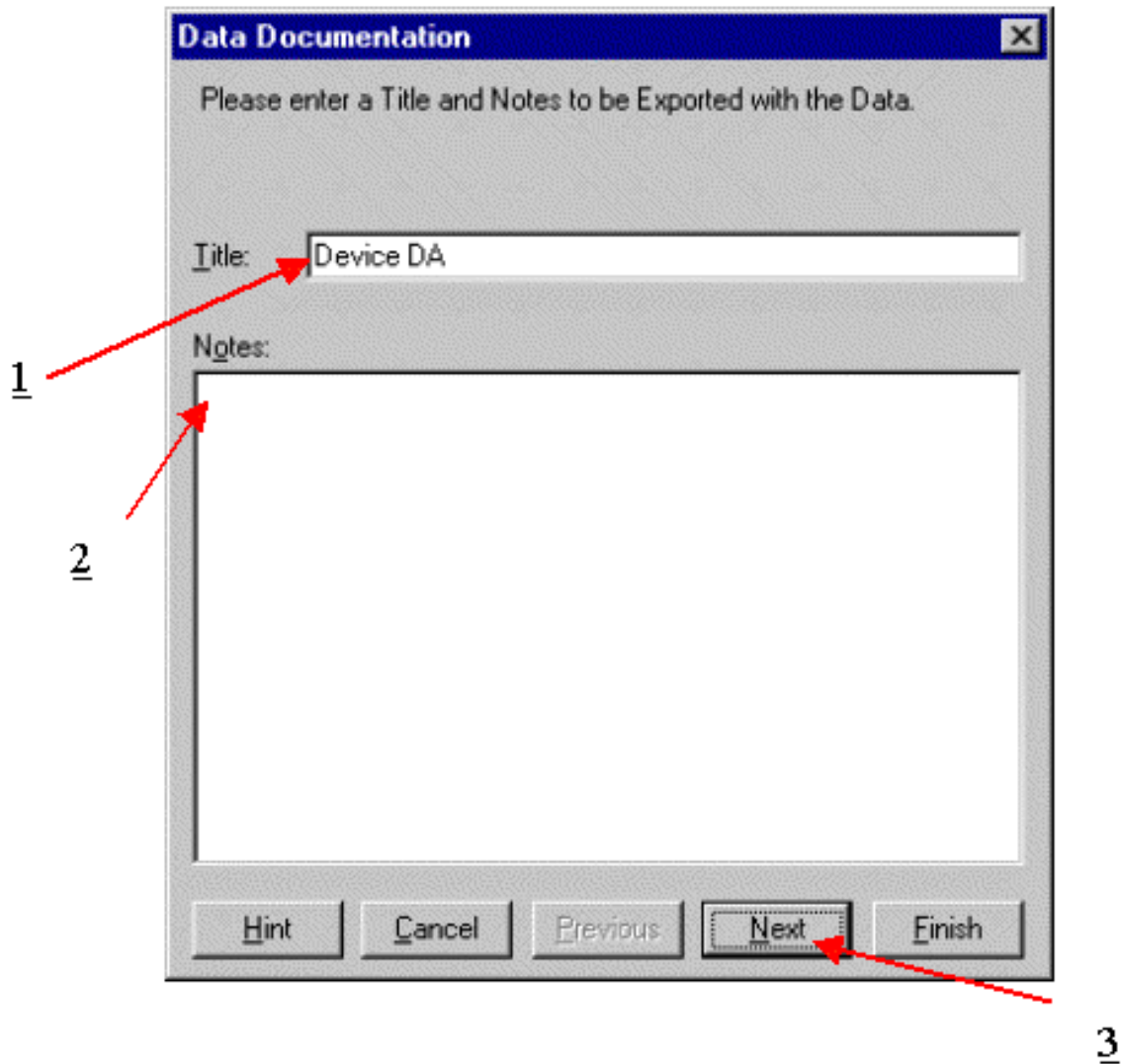

II. Give the File a Title and Notes:

1. Enter a title for the exported data.
2. Enter notes for the exported data.
3. Click the **Next** button.

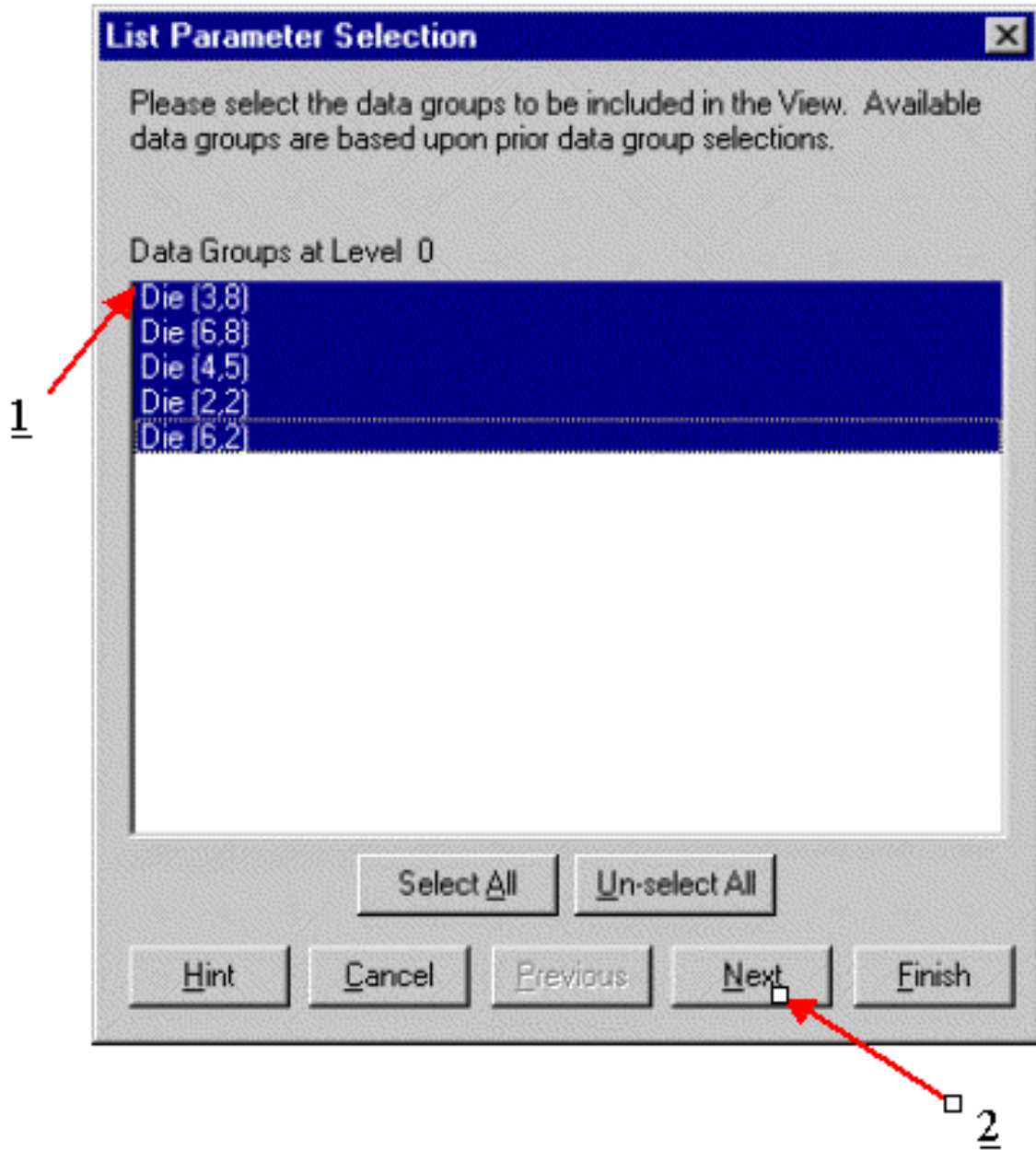

III. Select the Die locations to be exported:

1. Select the **Die** locations.
2. Click the **Next** button.

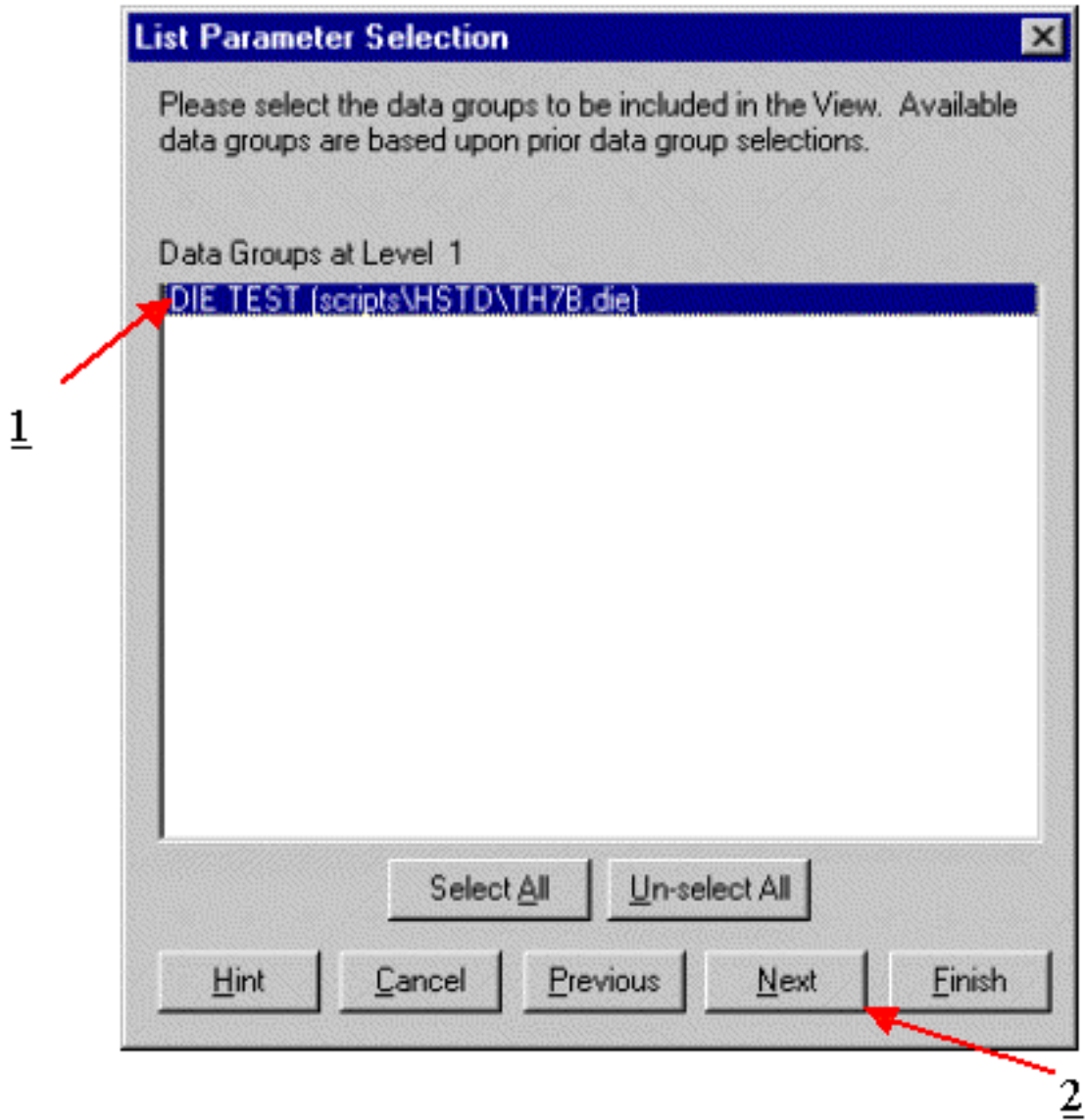

IV. Select the Die script that contains the parameter(s) to export:

1. Select the **Die Script**
2. Click the **Next** button.

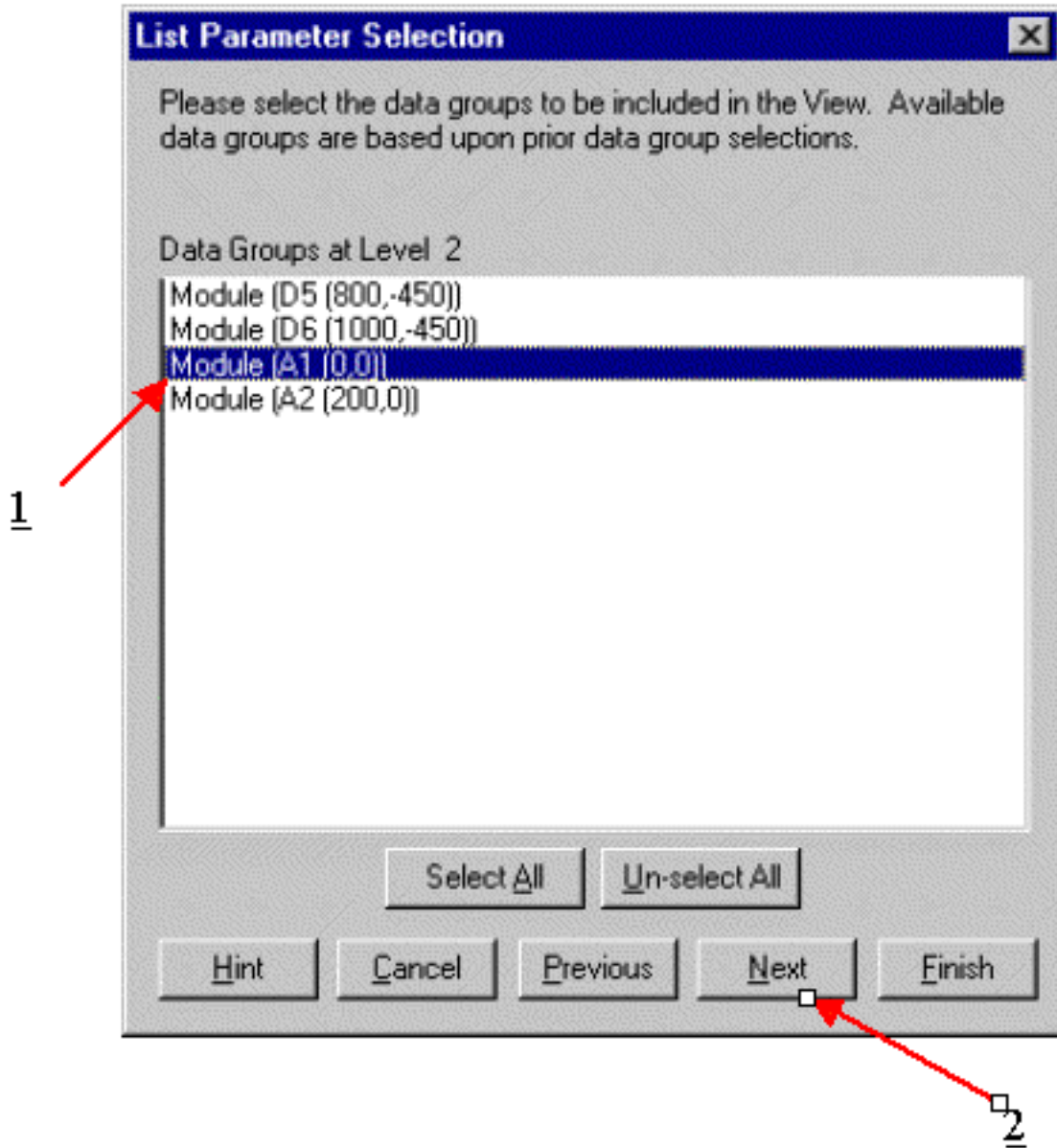

V. Select the Module that contains the parameter(s) to export:

1. Select the **Module**
2. Click the **Next** button.

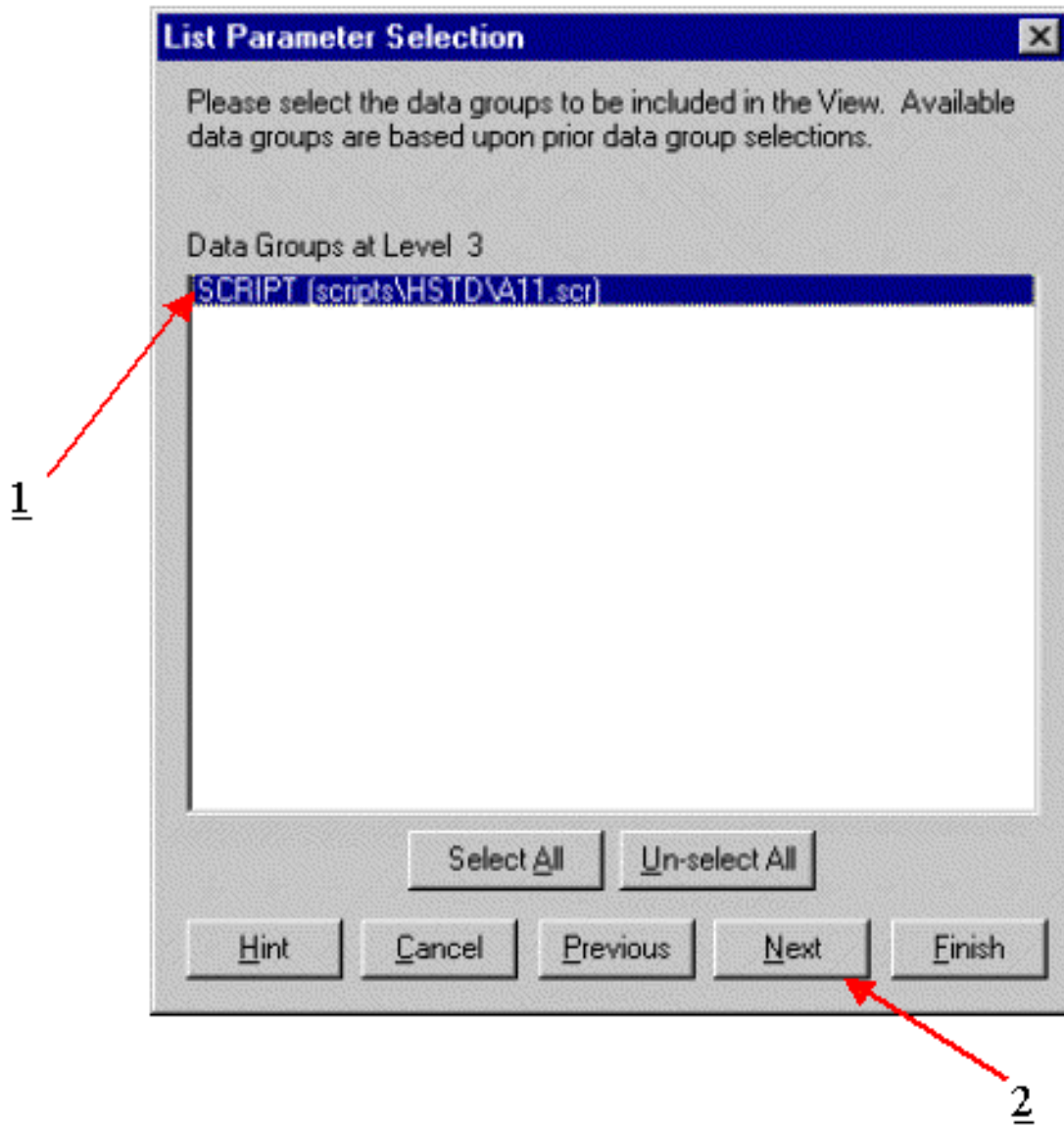

VI. Select the Module Script that contains the parameter(s) to export:

1. Select the **Module Script**
2. Click the **Next** button.

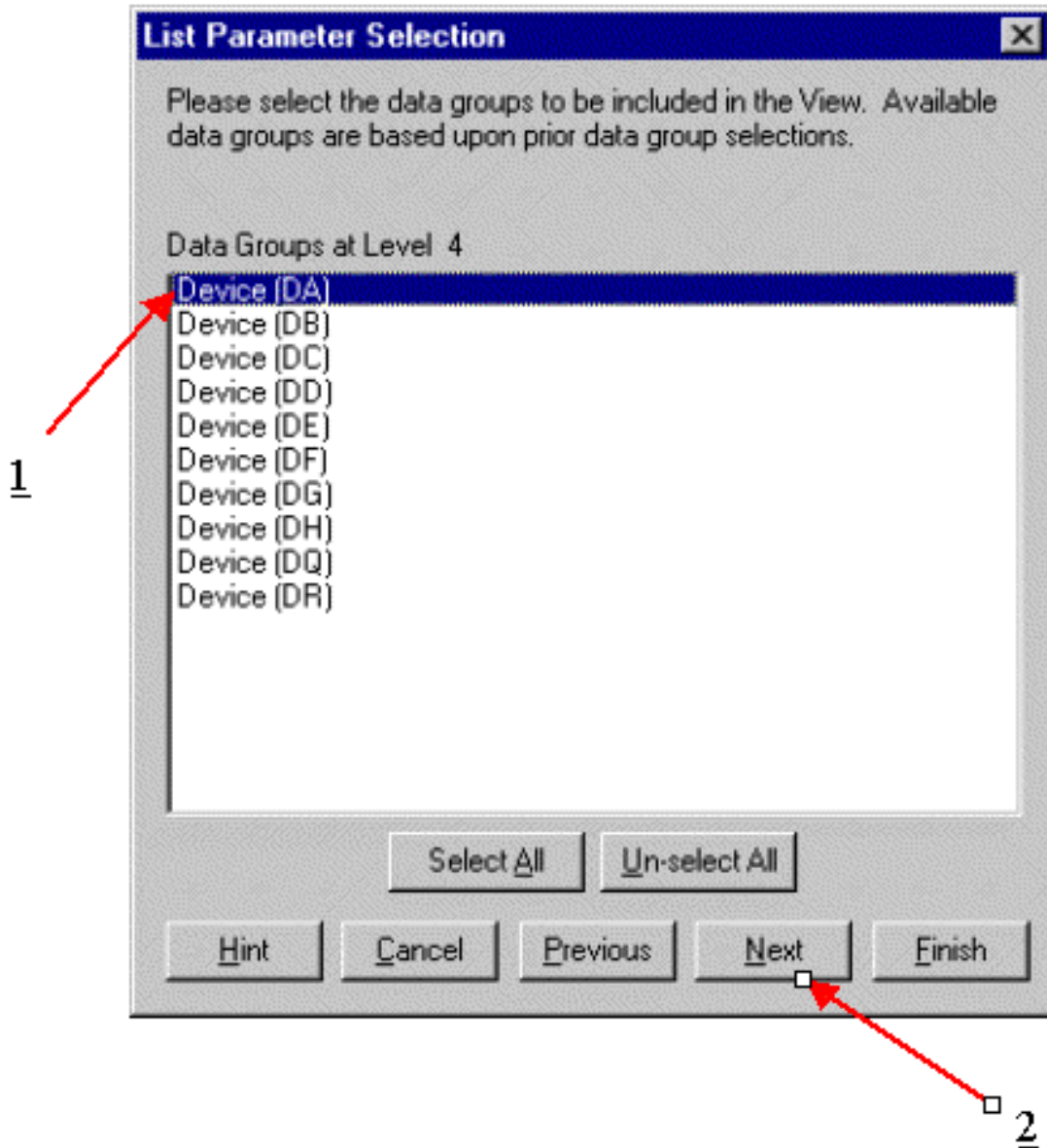

VII. Select the device whose parameter(s) is to be exported:

1. Select the **Device**
2. Click the **Next** button.

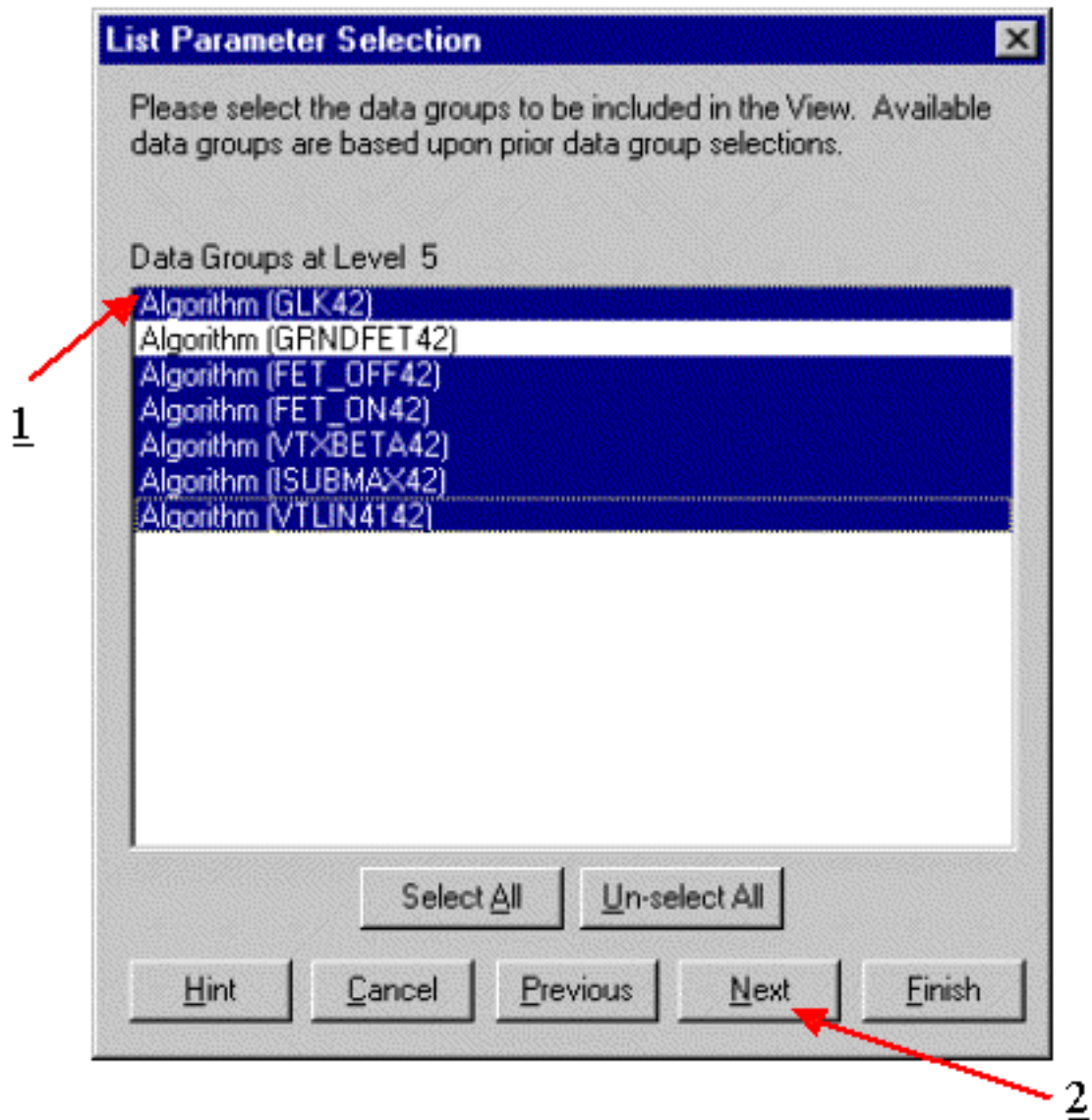

VIII. Select the Test algorithm(s) that contains the parameter(s) to export:

1. Select the test **Algorithm**. You can select more than one.
2. Click the **Next** button.

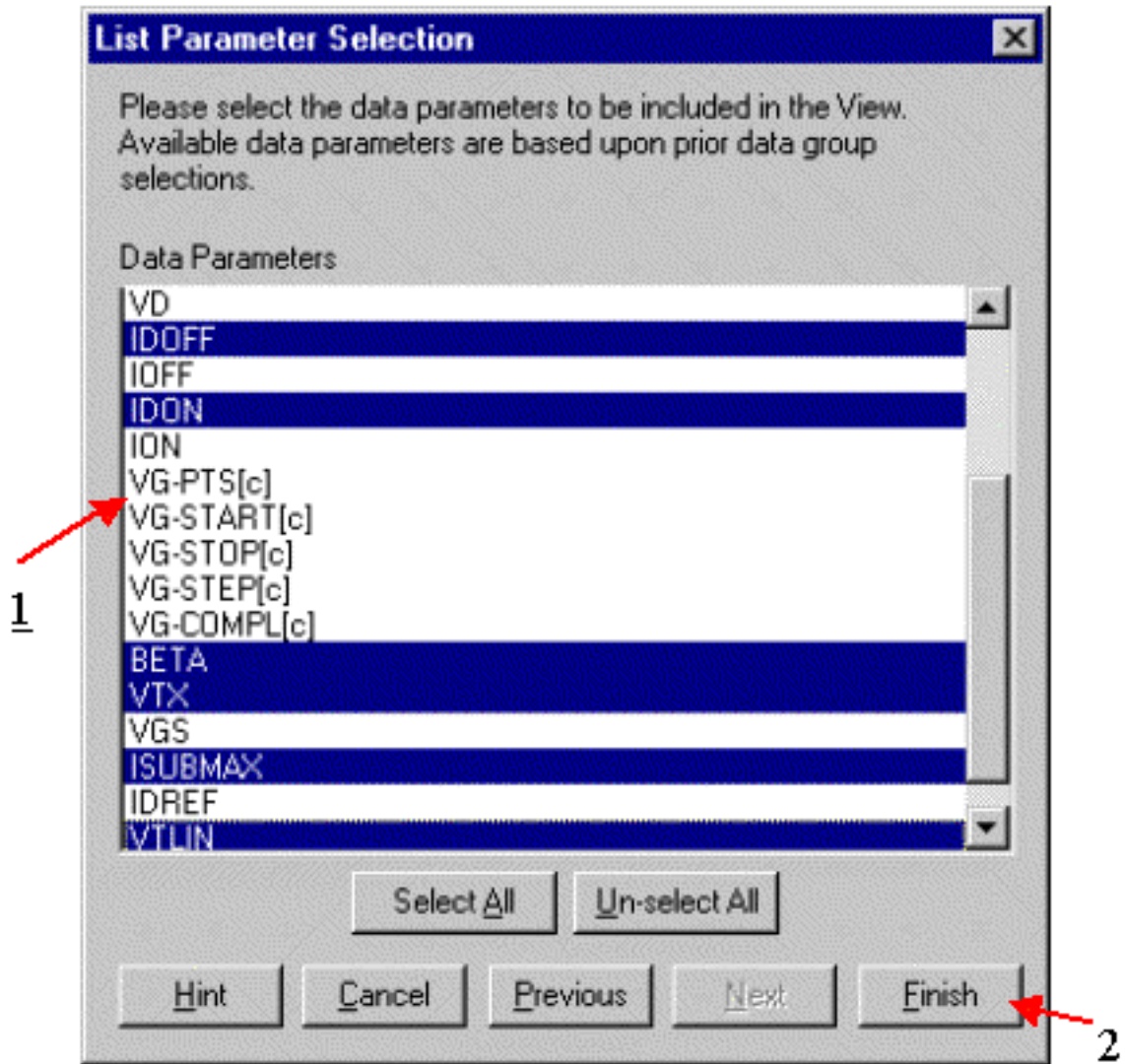

IX. Select the parameter(s) to export:

1. Select the **Parameter**. You can select more than one.
2. Click the **Next** button.

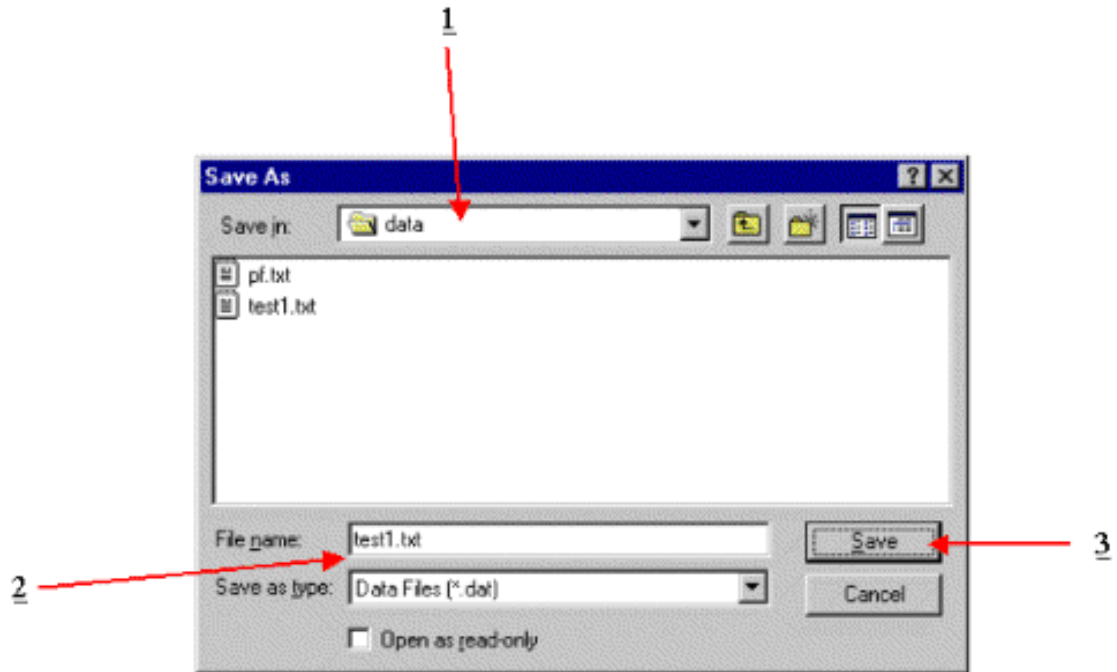

X. Select the file to save the parameters in:

1. Select the file directory.
2. Enter a file name.
3. Click the **Save** button.

Viewing Data

Metrics ICV contains a tool named the Metrics Data Browser. The Data Browser application is very useful for the viewing of the data. The data can be represented in table or plot form. After defining a plot, it is easy to select other locations and view the data.

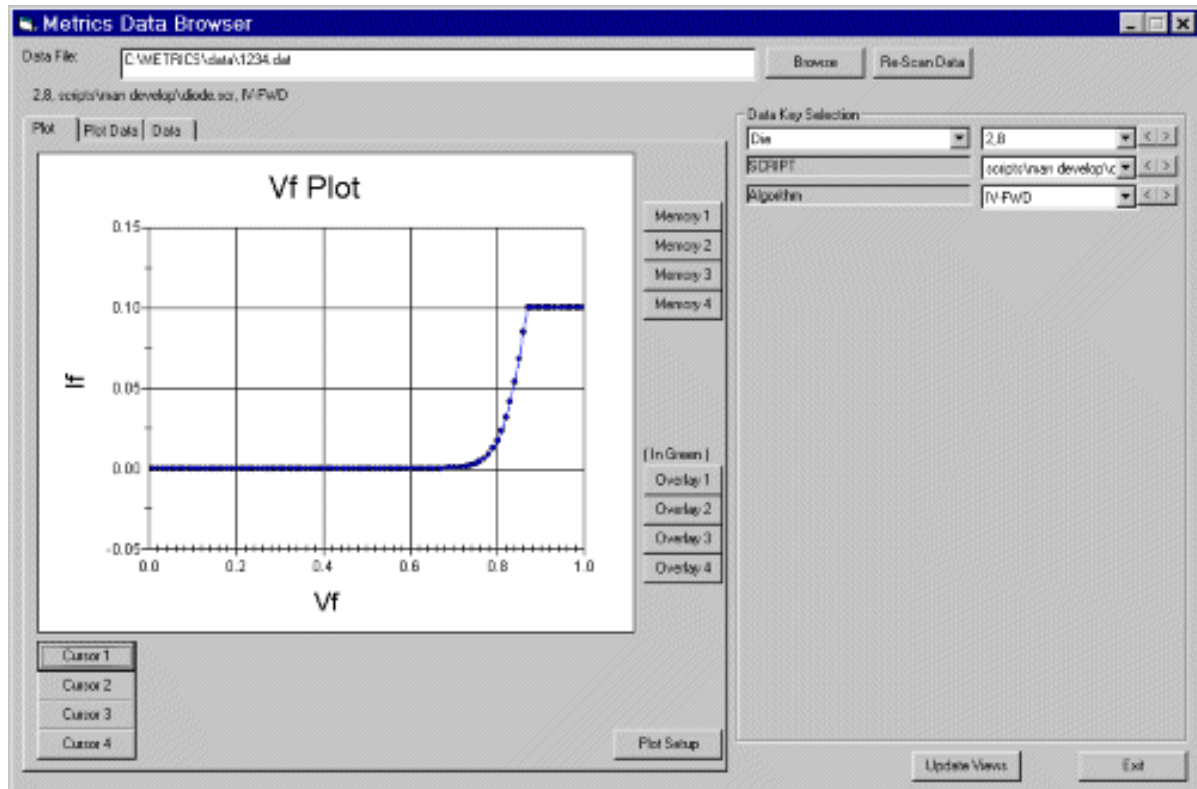

This example will demonstrate how to view Data Plots using the Metrics Data Browser.

The steps to view the data are:

A. Start Metrics Data Browser

The Metrics Data Browser can be started from the **Analysis >> Data Browser** menu item or the **Plot** button in the Analysis area of the Metrics ICV navigation window.

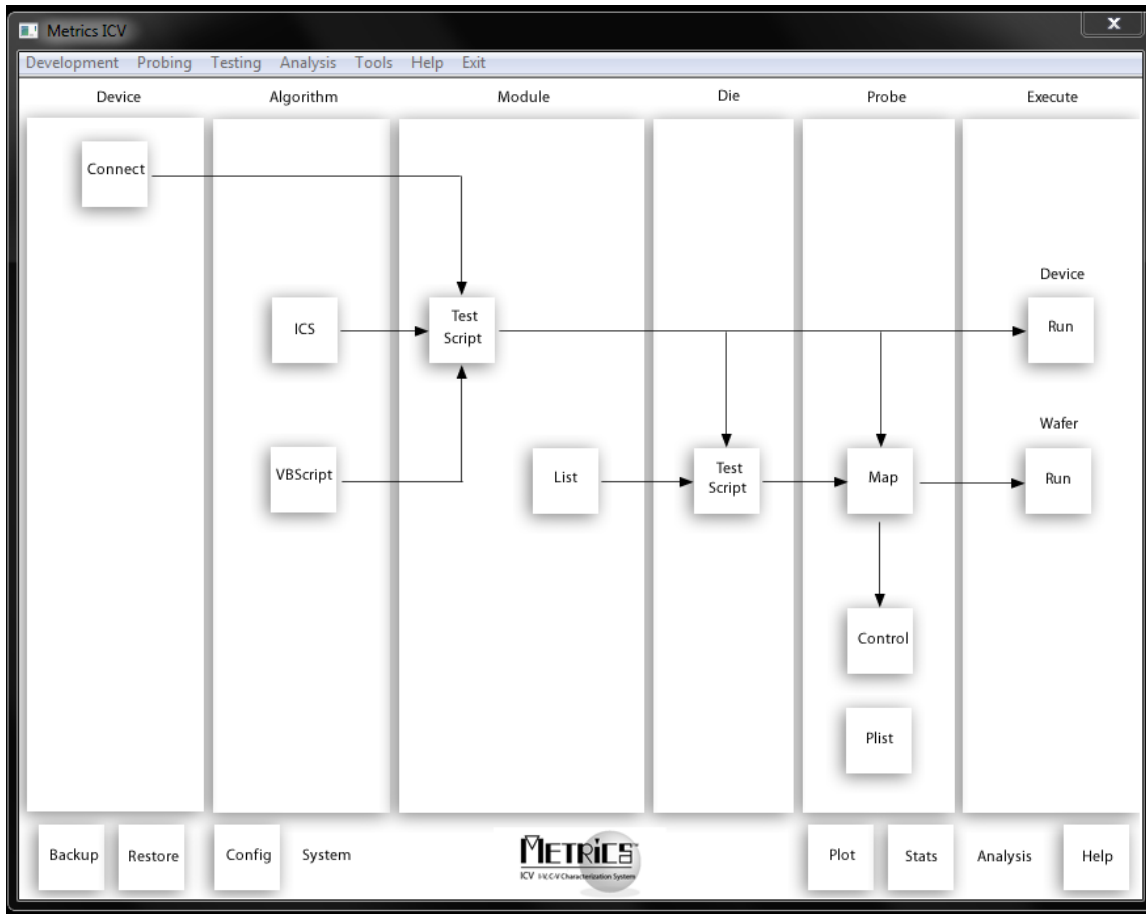

B. Load Data

The first step to viewing the data with Metrics Data Browser is to load the data from the saved data file.

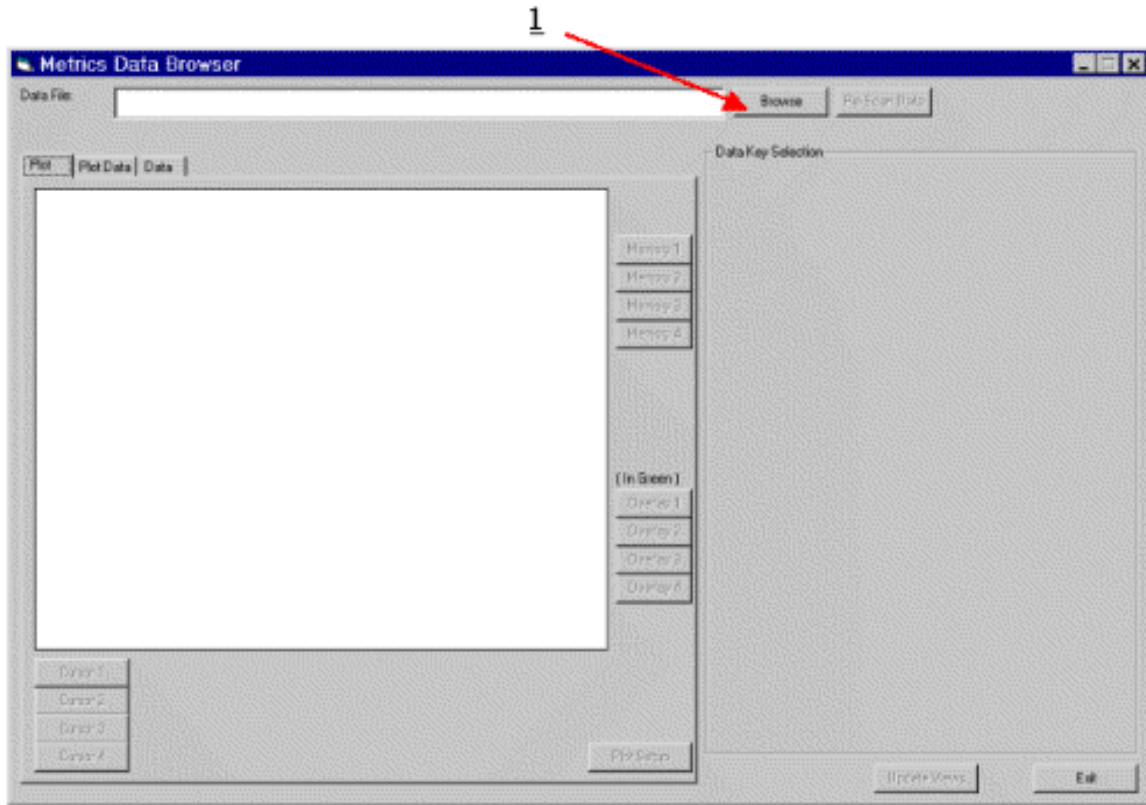

1. Click the **Browse** button.
2. Select the directory containing the data file.
3. Select the data file.
4. Click the **Open** button.

C. Setup the Plot

Once the data has been loaded it is ready to be plotted.

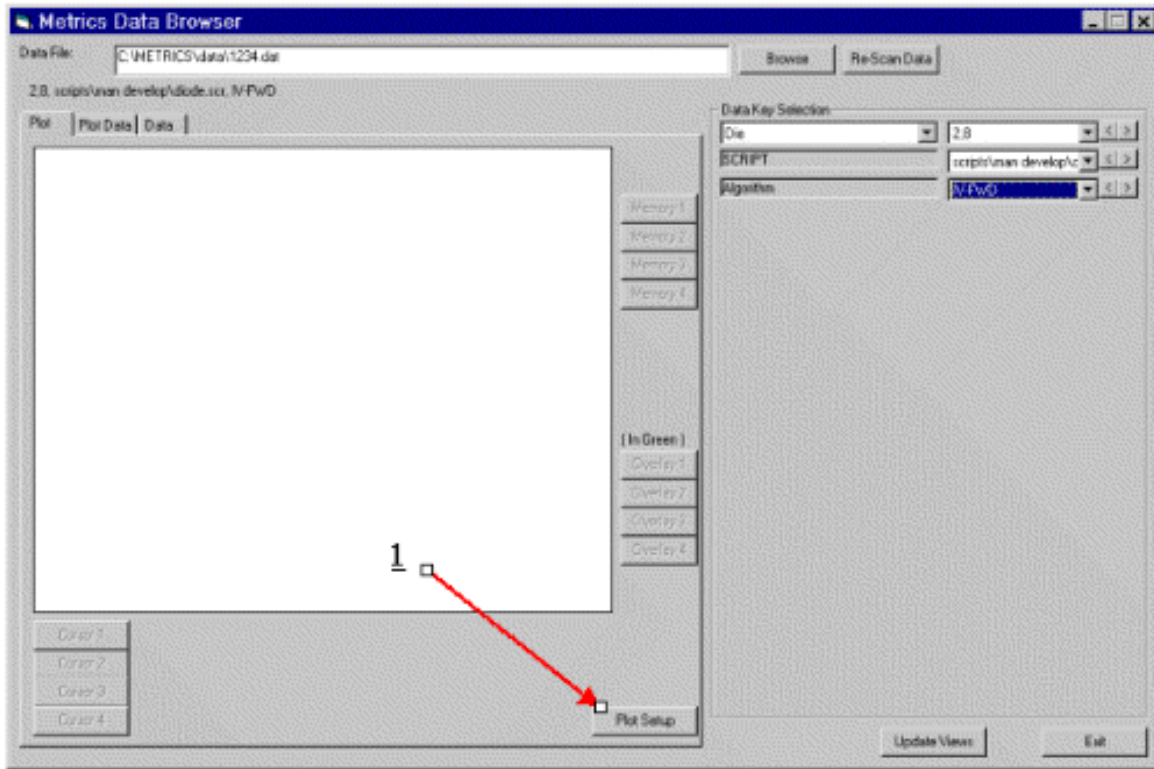

I. Open the Plot Setup window.

1. Click the **Plot Setup** button.

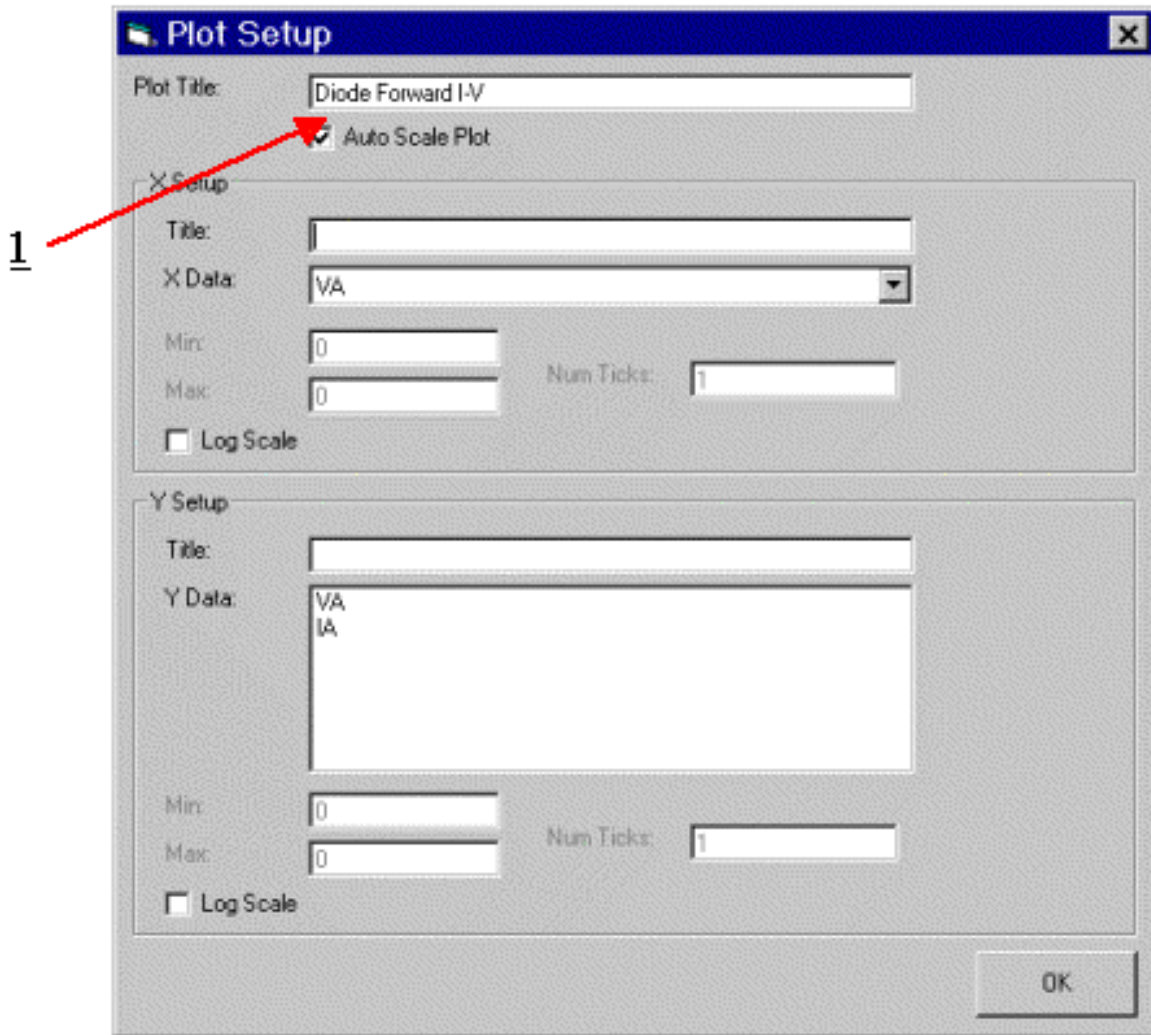

II. Provide a Plot title.

1. Highlight the **Title** window and enter a title for the plot.

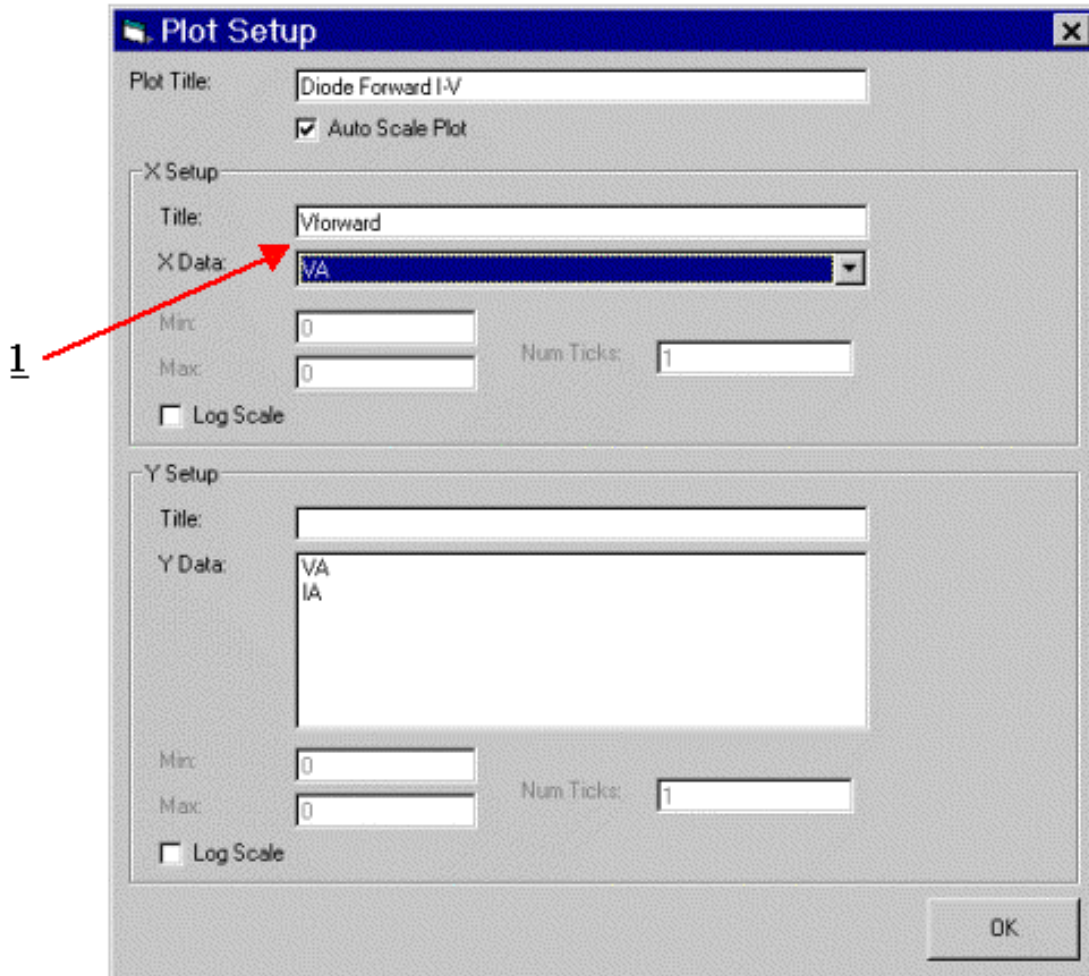

III. Setup the X-axis:

1. Enter a title for the x-axis.
2. Select the data vector for the x-axis.

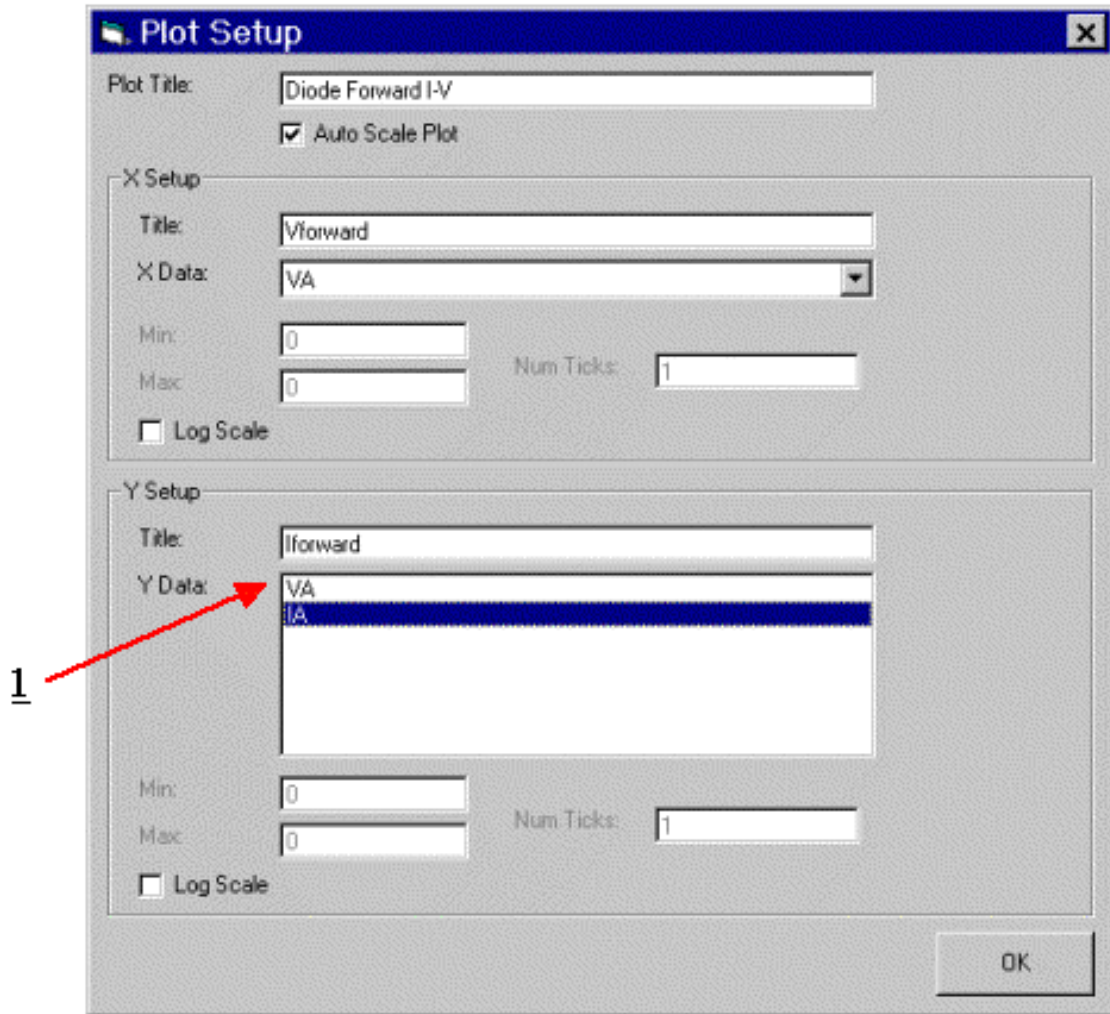

IV. Setup the Y-axis:

1. Enter a title for the y-axis.
2. Select the data vector(s) for the y-axis.
3. Click the **OK** button to close the Plot setup window.

D. Review Data

I. Select other die locations to view.

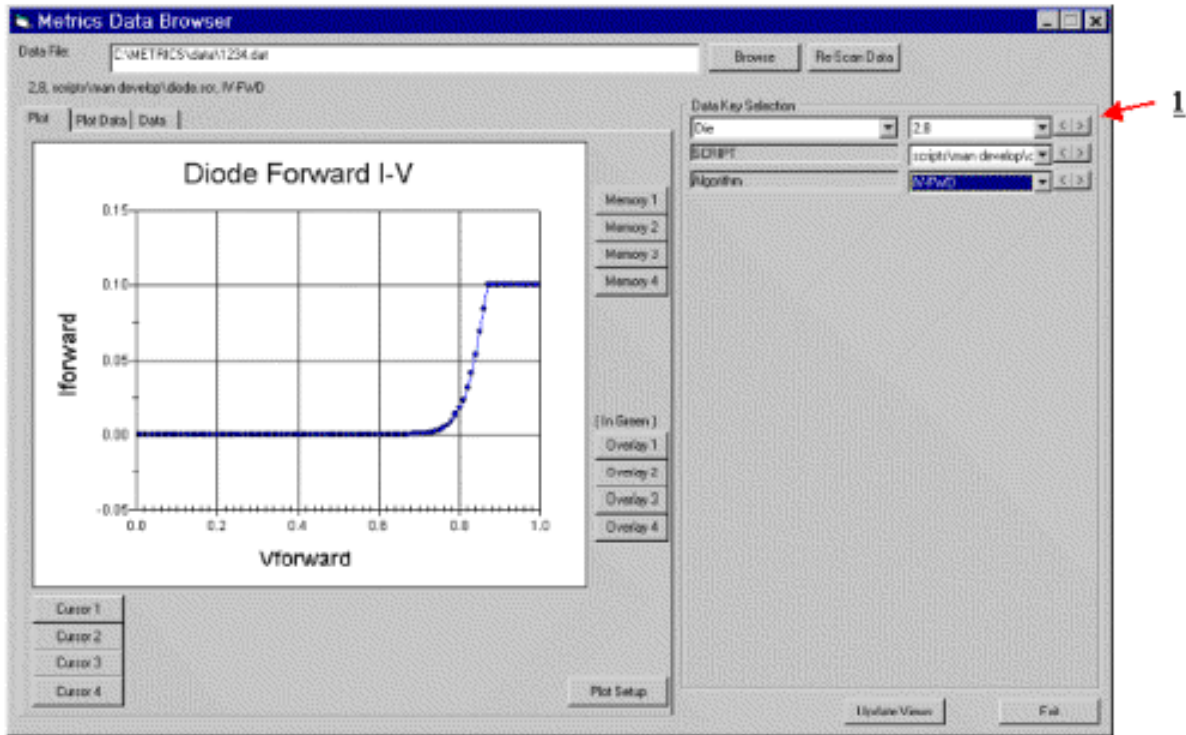

1. **Left** or **Right** buttons next to the die location to change sites.
2. The plot is automatically updated.

Chapter 11- System Backup and Restore

Introduction

A new feature of Metrics ICV is the ability to backup and restore the system using built-in functions. This feature is very useful for the rapid backup of a system into a single archive file.

Topics Covered

- How to backup
- Special requirements
- How to restore

How to Backup

The backup feature is designed to be very simple to use. The process is a simple three steps.

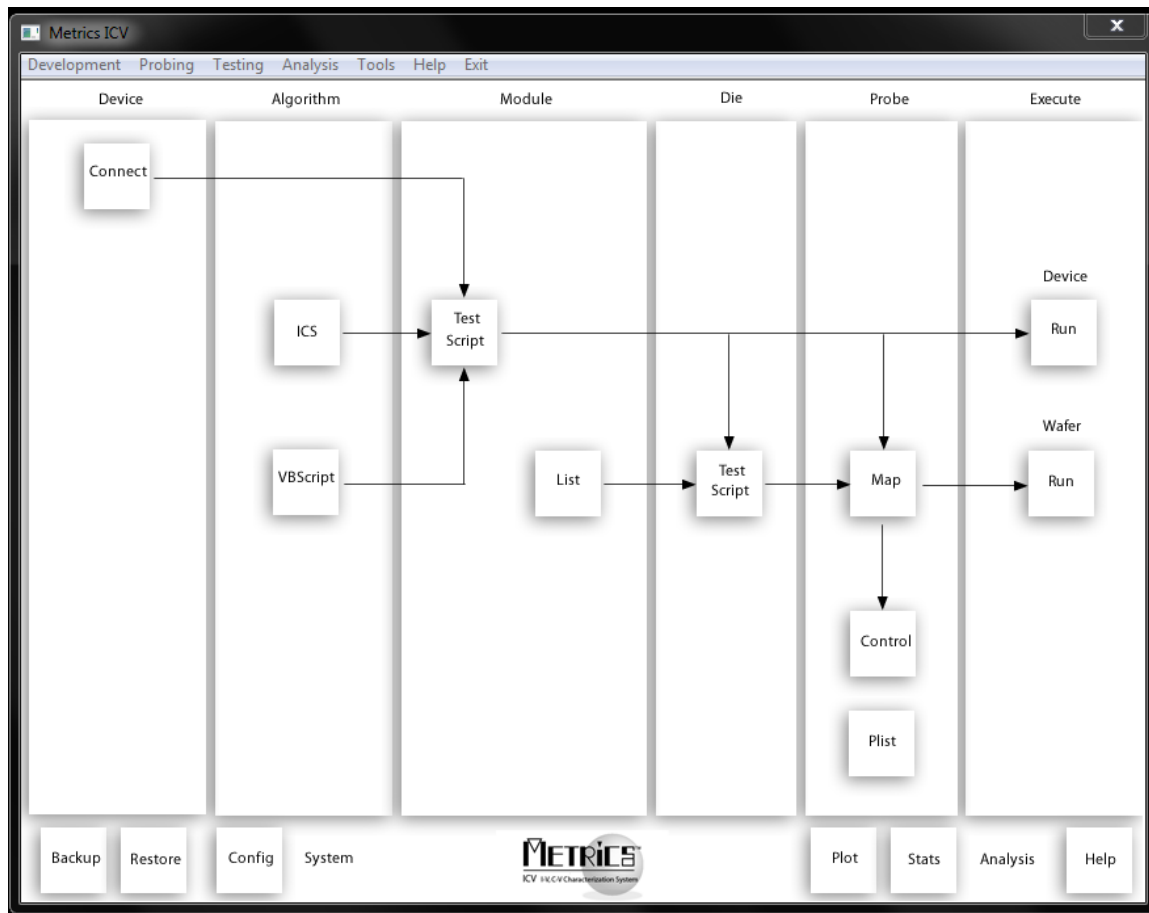

Create a Backup:

1. Select **Backup** from the Tools menu or the Backup button in the System area of the Metrics ICV navigation window.
2. Select the file name and location for the backup.
3. Click the **Open** button.
4. The Metrics ICV components will be compressed and stored.

Special Requirements

The backup feature is designed to be very simple to use. In order to make the feature as easy to use as possible, the default directories for saving components are backed up. The backup feature does not search for files saved in other locations.

Backup Directories

- Metrics\data
- Metrics\algs
- Metrics\ics\projects
- Metrics\reports
- Metrics\scripts
- Metrics\Wafermaps

How to Restore

The restore feature is designed to be very simple to use. The process is a simple two steps. The restore feature is designed to be used on a complete installation of Metrics ICV.

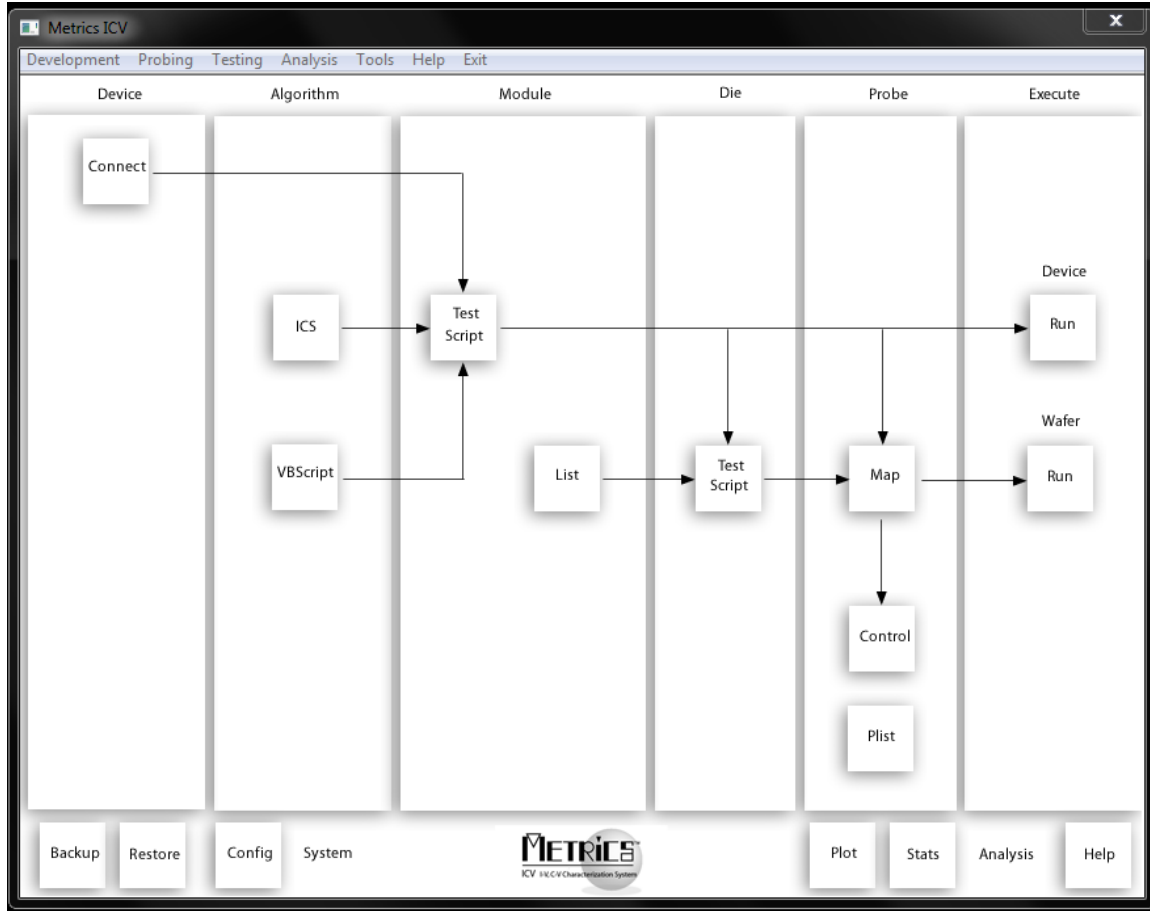

To Restore:

1. Remove the Metrics ICV software by using the Add/Remove feature of Windows (Control Panel)- remove all Metrics components.
2. Delete the Metrics directory.
3. Re-install the Metrics ICV software from CD.
4. Install the most current HotFix.
5. Select **Restore** from the Tools menu or the **Restore** button in the System area of the Metrics ICV navigation window.
6. The Metrics ICV components will be un-compressed and restored.